

D

D80
Manual 1.7 en

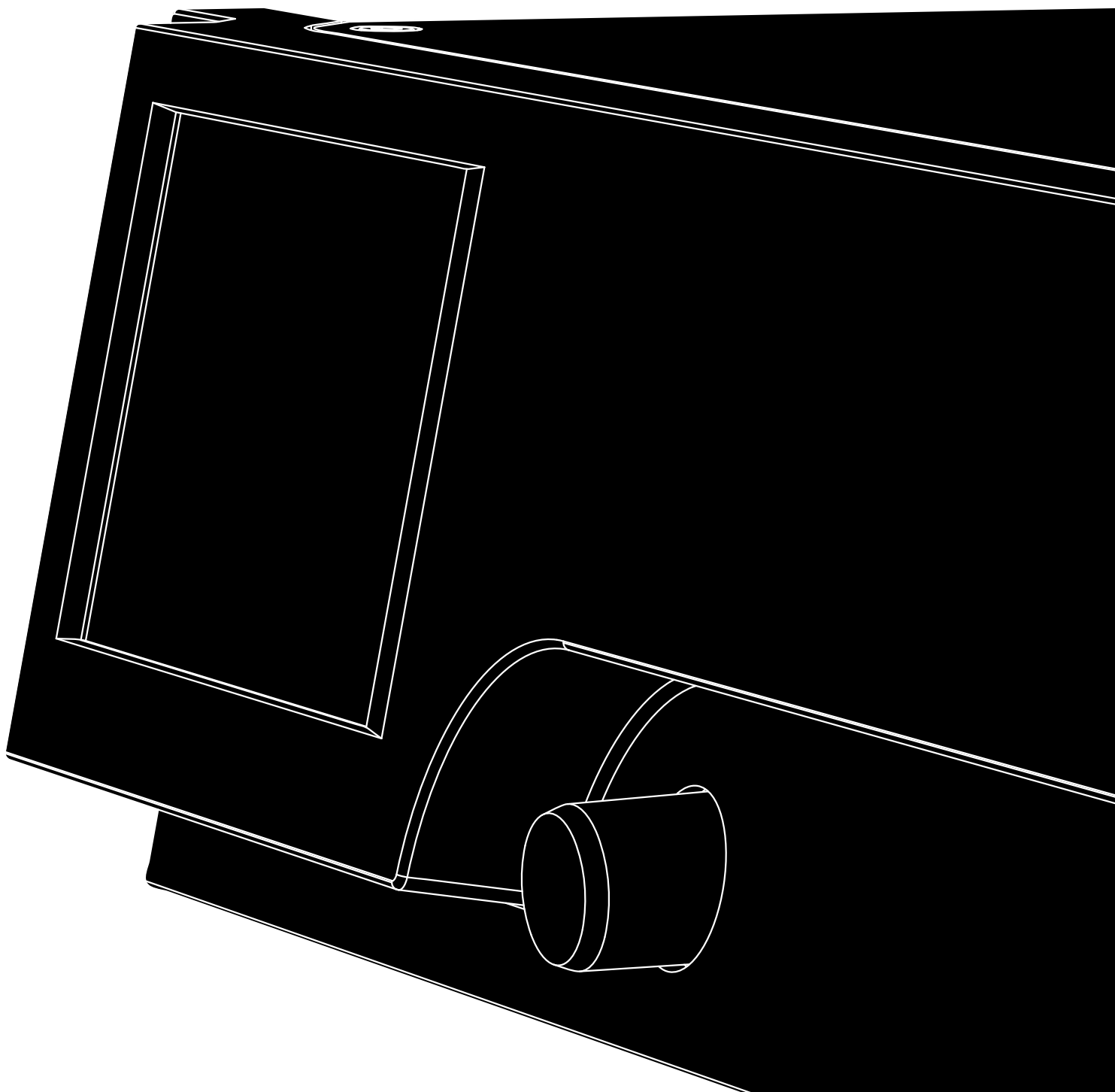

General information

D80 Manual

Version: 1.7 en, 03/2014, D2020.EN .01

Copyright © 2014 by d&b audiotechnik GmbH; all rights reserved.

Keep this manual with the product or in a safe place so that it is available for future reference.

We recommend you to regularly check the d&b website for the latest version of this manual.

When reselling this product, hand over this manual to the new customer.

If you supply d&b products, please draw the attention of your customers to this manual. Enclose the relevant manuals with the systems. If you require additional manuals for this purpose, you can order them from d&b.

d&b audiotechnik GmbH
Eugen-Adolff-Strasse 134, D-71522 Backnang, Germany
T +49-7191-9669-0, F +49-7191-95 00 00
docadmin@dbaudio.com, www.dbaudio.com

IMPORTANT SAFETY INSTRUCTIONS

Explanation of graphical symbols



The lightning symbol within a triangle is intended to alert the user to the presence of uninsulated "dangerous voltages" within the unit's chassis that may be of sufficient magnitude to constitute a risk of electric shock to humans.



The exclamation point within a triangle is intended to alert the user to the presence of important operating and service instructions in the literature accompanying the product.

Before using this product, carefully read the applicable items of the following safety instructions.

1. Keep these instructions for future reference.
2. Read these instructions.
3. Heed all warnings.
4. Follow all instructions.
5. Keep water or other liquids away from the unit. Do not place liquid filled containers, for example beverages, on top of the unit.
6. Do not operate the unit while it is wet or standing in liquid.
7. Always operate the unit with the chassis ground wire connected to the electrical safety earth. Do not defeat the safety purpose of a grounding-type plug. A grounding-type plug has two blades and a third grounding prong. The third prong is provided for your safety. If the provided plug does not fit into your outlet, consult an electrician for replacement of the obsolete outlet.
8. Do not use this unit if the power cord is damaged or frayed. Protect the power cord from being walked upon or pinched, particularly at the plugs and the point where it exits from the apparatus.
9. The unit is intended for use in a 19" rack. Follow the mounting instructions. When a rack on wheels is used, exercise caution when moving the loaded rack to avoid injury from tipping over.
10. Unplug this apparatus during lightning storms or when unused for long periods of time.
11. Never connect an output pin to any other amplifier input or output pin or to the earth (ground). This may damage the unit or lead to electric shock.
12. Lay all cables connected to the unit carefully so that they cannot be crushed by vehicles or other equipment and that no one can either step on them or trip over them.
13. Refer all servicing to qualified service personnel. Servicing is required when the apparatus has been damaged in any way such as:
 - Power-supply cord or plug is damaged.
 - Liquid has been spilled into the unit.
 - An object has fallen into the unit.
 - The unit has been exposed to rain or moisture.
 - The unit does not operate normally.
 - The unit was dropped or the chassis is damaged.
 - Do not remove top or bottom covers. Removal of the covers will expose hazardous voltages. There are no user serviceable parts inside and removal may void the warranty.
14. Use the mains plug as the disconnecting device and keep it readily accessible. If the mains plug is not readily accessible due to mounting in a 19" rack, then the mains plug for the entire rack must be readily accessible.
15. An experienced user must always supervise the equipment, especially if inexperienced adults or minors are using the equipment.

| | |
|--|-----------|
| 1. Introduction | 6 |
| 1.1. Intended use | 6 |
| 1.2. D80 Concept | 6 |
| 2. Technical specifications | 8 |
| 3. Scope of supply | 10 |
| 4. Startup | 11 |
| 4.1. Overview | 11 |
| 4.2. Rack mounting and cooling | 12 |
| 4.3. Connections | 14 |
| 4.3.1. Mains connection | 14 |
| 4.3.2. Audio INPUT and LINK connectors | 16 |
| 4.3.3. Output connectors | 17 |
| 4.3.4. ETHERNET (Dual Ethernet port) | 18 |
| 4.3.5. CAN (CAN-Bus) | 19 |
| 4.4. Controls and indicators | 20 |
| 4.4.1. Mains power switch | 20 |
| 4.4.2. Display - User interface | 20 |
| 4.4.3. Standby mode | 21 |
| 4.4.4. Mute functions | 22 |
| 5. User interface | 23 |
| 5.1. Operating concept | 23 |
| 5.2. Screen layout and conventions | 24 |
| 5.3. Screen items and views | 24 |
| 5.3.1. Function buttons | 24 |
| 5.3.2. Navigation buttons | 24 |
| 5.3.3. Input fields | 25 |
| 5.3.4. Input masks | 25 |
| 5.3.5. Information fields | 25 |
| 6. Home screen | 26 |
| 6.1. Header area - Device | 27 |
| 6.2. Data area - Channel strip(s) | 27 |
| 7. Channel strip | 28 |
| 8. Basic settings - Quick reference | 30 |
| 9. Device setup | 32 |
| 9.1. Device name | 33 |
| 9.2. Input | 34 |
| 9.2.1. Input mode | 34 |
| 9.3. Output | 36 |
| 9.3.1. Output mode | 37 |
| 9.4. Remote | 41 |
| 9.4.1. Remote ID | 41 |
| 9.4.2. Ethernet settings | 41 |
| 9.5. More | 42 |
| 9.5.1. Preferences | 42 |
| 9.5.1.1. Display | 43 |
| 9.5.1.2. Lock | 43 |
| 9.5.1.3. Preferences/More | 45 |

| | |
|---|-----------|
| 9.5.1.3.1. System reset..... | 45 |
| 9.5.2. Info..... | 46 |
| 9.5.3. Levels..... | 47 |
| 9.5.4. Mains current limiter (MCL)..... | 48 |
| 9.5.5. Scope..... | 49 |
| 10. Channel setup..... | 50 |
| 10.1. Channel name..... | 51 |
| 10.2. Configuration switches - Filter_1, _2, _3..... | 52 |
| 10.3. Level..... | 52 |
| 10.4. EQ - Equalizer | 52 |
| 10.5. DLY - Delay..... | 55 |
| 10.6. Input routing..... | 55 |
| 10.7. Speaker..... | 56 |
| 10.7.1. LINEAR setup..... | 57 |
| 10.7.2. LoadMatch..... | 58 |
| 10.8. Frequency generator - Freq. gen..... | 59 |
| 11. Web Remote interface..... | 60 |
| 12. Error messages..... | 62 |
| 13. Operation (Hardware references)..... | 66 |
| 13.1. Power supply..... | 66 |
| 13.1.1. Active Power Factor Correction (PFC)..... | 66 |
| 13.1.2. Automatic mains range selection..... | 66 |
| 13.1.3. Mains voltage monitoring..... | 66 |
| 13.1.4. Mains inrush current limiter..... | 67 |
| 13.1.5. Mains supply requirements..... | 67 |
| 13.1.6. Generator operation/UPS requirements..... | 68 |
| 13.2. Power amplifiers..... | 68 |
| 13.3. Cooling fans..... | 69 |
| 13.4. Current/power draw and thermal dissipation..... | 69 |
| 14. Service/Maintenance and care..... | 71 |
| 14.1. Service..... | 71 |
| 14.2. Maintenance and care..... | 71 |
| 15. Manufacturer's Declarations..... | 72 |
| 15.1. EU declaration of conformity (CE symbol)..... | 72 |
| 15.2. WEEE Declaration (Disposal)..... | 72 |
| 15.3. Licenses and Copyright..... | 72 |

1. Introduction

1.1. Intended use

The d&b D80 amplifier is designed for use with all current d&b loudspeakers. A LINEAR setup is available allowing the D80 to be used as a linear power amplifier.

NOTICE!

The unit complies with the electromagnetic compatibility requirements of EN 55103 (product family standard for audio, video, audio-visual and entertainment lighting control apparatus for professional use) for the environments E1 (residential), E2 (business and commercial), E3 (outdoor use in urban areas) and E4 (outdoor use in rural areas).

Acoustic interference and malfunctions may occur if the unit is operated in the immediate vicinity of high-frequency transmitters (e.g. wireless microphones, mobile phones, etc.). Damage to the unit is unlikely, but cannot be excluded.

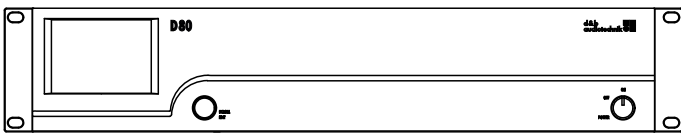

D80 Front view

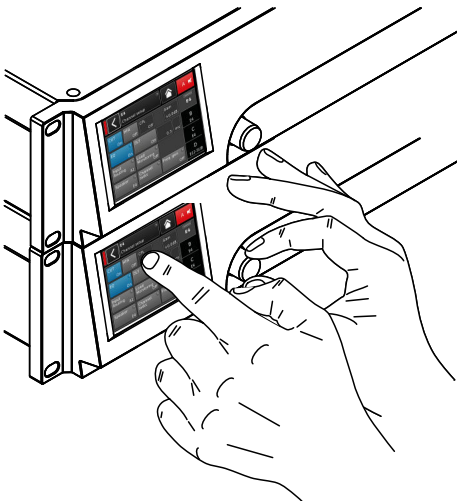

D80 User interface

1.2. D80 Concept

The D80 amplifier represents the next generation of high power four channel Class D amplifiers. It is developed and manufactured by d&b using Digital Signal Processing (DSP) to incorporate loudspeaker specific configurations and user definable setups, equalization and delay functions. The amplifier is designed to fully drive all d&b loudspeakers and provide comprehensive management and protection capabilities. This high performance amplifier provides the power density required for both touring and installation purposes while the powerful signal processing extends the level of functionality of the on-board features.

The user interface of the amplifier consists of two elements: a color TFT touch screen providing visual information and quick access to the amplifier settings and a rotary encoder on the front panel for data input purposes. To allow ease of operation when the amplifier is below eye level, the front panel and the integrated display are tilted upwards. As a result, the front panels of multiple amplifiers on top of each other within a rack integrate to form one large control surface.

The user definable equalizer features two independent 16-band EQ groups within each channel. These provide parametric, notch, shelving and asymmetric filters as well as a graphic EQ (via the d&b R1 Remote control software V2) allowing instant switching between two EQ curves for comparison. The delay capability covers a range of up to 10 s. All loudspeaker specific functions such as CUT, HFA, HFC, CSA or CPL are available. The DSP unit of the amplifier has a fixed latency of 0.3 ms.

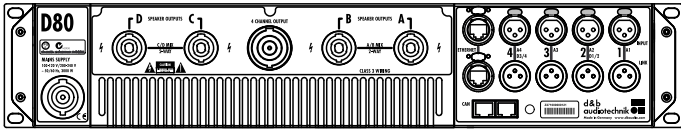

D80 Rear view

The amplifier enables up to four input channels, which may be four analog inputs, two analog and two AES channels or four AES channels. Each input channel can be routed to any of the output channels A to D. XLR connectors 2 and 4 of the D80 can be used as either digital or analog inputs, connectors 1 and 3 are analog inputs. Link outputs are supplied for all inputs. This 1:1 ratio of inputs to amplifier output channels increases flexibility of application, particularly for use as monitor, frontfill or effect channels.

The D80 amplifier outputs are optionally NL4 or EP5 connectors plus one centered NL8 connector with all pins driven. The latter serves as an interface to a rack panel or to loudspeaker multicore and breakout adapters. To simplify configuration, the output mode of the amplifier can be configured like a set of two dual channel amplifiers providing Dual Channel, Mix TOP/SUB or 2-Way Active modes for the left and the right channels A/B and C/D, respectively.

For applicable loudspeakers, d&b LoadMatch enables the D80 amplifier to electrically compensate for the properties of the cable used to connect the loudspeakers to the amplifier output. This function which covers a bandwidth of up to 20 kHz preserves the tonal balance when cable lengths of up to 70 m (230 ft) are used. Due to its design LoadMatch does not require additional wires and is therefore applicable with any connector type used. To provide optimum compensation, cable length and cross-sectional data as well as the number of loudspeakers connected to the amplifier channel can be entered on the amplifier.

The D80 utilizes a switch mode power supply with active PFC to produce a clean current draw and ensure stable and efficient performance under adverse mains conditions. The high power capabilities provide increased power to fully drive all current d&b loudspeaker cabinets and sufficient headroom for any future systems.

Remote control and full system integration are realized using the d&b ArrayCalc simulation software and R1 Remote control software V2. The D80 amplifier includes two Ethernet ports on etherCON connectors to enable daisy chaining. Both Ethernet and dbCAN protocols are incorporated. The Ethernet protocol implemented in the d&b R1 Remote control software V2 and the D80 amplifier is a protocol developed by the OCA Alliance (Open Control Architecture Alliance), of which d&b is a founding member. For further details, please refer to the OCA website: www.oca-alliance.com.

2. Technical specifications

Audio data (linear setting with subsonic filter)

| | |
|---|-----------------|
| Maximum output power per channel (THD + N < 0.5 %, all channels driven) | |
| CF = 6 dB @ 4/8 ohms | 4 x 2600/2000 W |
| CF = 12 dB @ 4/8 ohms | 4 x 4000/2000 W |
| Maximum output voltage | 180 V |
| Frequency response (-1 dB) | 35 Hz - 20 kHz |
| THD+N (20 Hz - 20 kHz, 600 W @ 4 ohms) | < 0.1% |
| S/N ratio (unweighted, RMS) | |
| Analog input | > 110 dB |
| Digital input | > 114 dB |
| Damping factor (20 Hz - 200 Hz into 4 ohms) | > 100 |
| Crosstalk (20 Hz - 20 kHz) | < -70 dB |
| Gain (Linear mode @ 0 dB) | 31 dB |

Protection circuits

| | |
|---|-------------------------------|
| Mains inrush current limiter | 13 A _{RMS} @ 230 VAC |
| | 22 A _{RMS} @ 120 VAC |
| | 27 A _{RMS} @ 100 VAC |
| Ground fault protection | |
| Output current limitation/protection | 65 A / 75 A |
| Output DC offset protection | 10 V |
| Output HF Voltage Limiter | 60 V @ 10 kHz |
| Output pop-noise suppression | |
| Mains Current Limitation (MCL) | 95 to 50 % of 16 / 30 A |
| Overvoltage protection | Up to 400 VAC |
| Self-resetting overtemperature protection | |

Power supply

| | |
|--|--------------------------|
| Autosensing switched mode power supply with active power factor correction (PFC) | |
| Mains connector | powerCON-HC |
| Rated mains voltage | 208 to 240 V, 50 - 60 Hz |
| | high range |
| | 100 to 127 V, 50 - 60 Hz |
| | low range |
| Mains fuse | internal |

Power consumption (typical values)

| | |
|---|--------|
| Standby | 9 W |
| Idle | 180 W |
| Max. power consumption (short term RMS) | 7000 W |

Operating conditions

| | |
|--|---|
| Temperature range* | -10 °C ... +40 °C / +14 °F ... +104 °F |
| | * continuous operation |
| Temperature range** | -10 °C ... +50 °C / +14 °F ... +122 °F |
| | ** reduced output power or short term operation |
| Storage temperature | -20 °C ... +70 °C / -4 °F ... +158 °F |
| Humidity (rel.), long term average | 70% |

Audio input connectors

| | |
|--|--|
| INPUT analog (A1 - A4) | 3 pin XLR female |
| Pin assignment | 1 = GND, 2 = pos., 3 = neg. |
| Input impedance | 38 kOhms, electronically balanced |
| Common mode rejection (CMRR @ 100 Hz/10 kHz) | > 70 / 50 dB |
| Maximum input level (balanced/unbalanced) | +25 / 17 dBu |
| | +27 dBu @ 0 dBFS |
| LINK analog (A1 - A4) | 3 pin XLR male |
| Pin assignment | 1 = GND, 2 = pos., 3 = neg. |
| | parallel to input |
| INPUT digital (D1/2, D3/4) | 3 pin XLR female, AES 3 |
| Pin assignment | 1 = GND, 2 = AES Signal, 3 = AES Signal |
| Input impedance | 110 ohms, transformer balanced |
| Sampling | 48 / 96 kHz / 2 Ch/n |
| Synchronization | Word-Sync: PLL-locked to source (slave mode) |
| LINK digital (Output) | 3 pin XLR male |
| | electronically balanced |
| | analog signal buffering (refresh), power fail relay (Bypass) |

Output connectors

| | |
|-------------------------------|-------------------|
| SPEAKER OUTPUTS A/B/C/D | 4 x NL4 |
| | optional: 4 x EP5 |
| 4 CHANNEL OUTPUT | 1 x NL8 |

Network connectors

| | |
|----------------|---|
| CAN | 2 x RJ 45 parallel |
| ETHERNET | 2 x etherCON® |
| | Dual Ethernet port with built-in 2-port Ethernet switch |
| | 10/100 Mbit |

Controls and indicators

| | |
|-------------------|--|
| POWER | Mains power switch |
| SCROLL/EDIT | Digital rotary encoder |
| Display | TFT color touch screen, 3.5" / 320 x 240 Pixel |

Digital Signal Processing

| | |
|-----------------------------------|--|
| System start-up time | 17 sec. |
| Sampling rate | 96 kHz / 27 Bit ADC / 24 Bit DAC |
| Latency analog input | 0.3 msec. |
| Latency digital input (AES) | 0.3 msec. |
| | 48 kHz / 96 kHz |
| Input dynamic | > 127 dB |
| ADC dynamic | > 110 dB |
| DAC dynamic | > 110 dB |
| Equalizer | two user definable 16-band equalizers |
| | Filter types: PEQ/Notch/HiShlv/LoShlv/Asym |
| Delay | 0.3 msec. - 10 sec. |
| Frequency generator | Pink noise or Sine wave 10 Hz - 20 kHz |

Fan noise emission

Rack mounted, measured on axis, 1 m to front panel, A-weighting
 Idle.....34 dB(A)
 Ambient temperature 22 °C / 71.6 °F
 Max. RPM.....49 dB(A)

Dimensions and weight

Height x width x depth.....2 RU x 19" x 530.5 mm
 2 RU x 19" x 20.9"
 Weight 19 kg / 42 lb

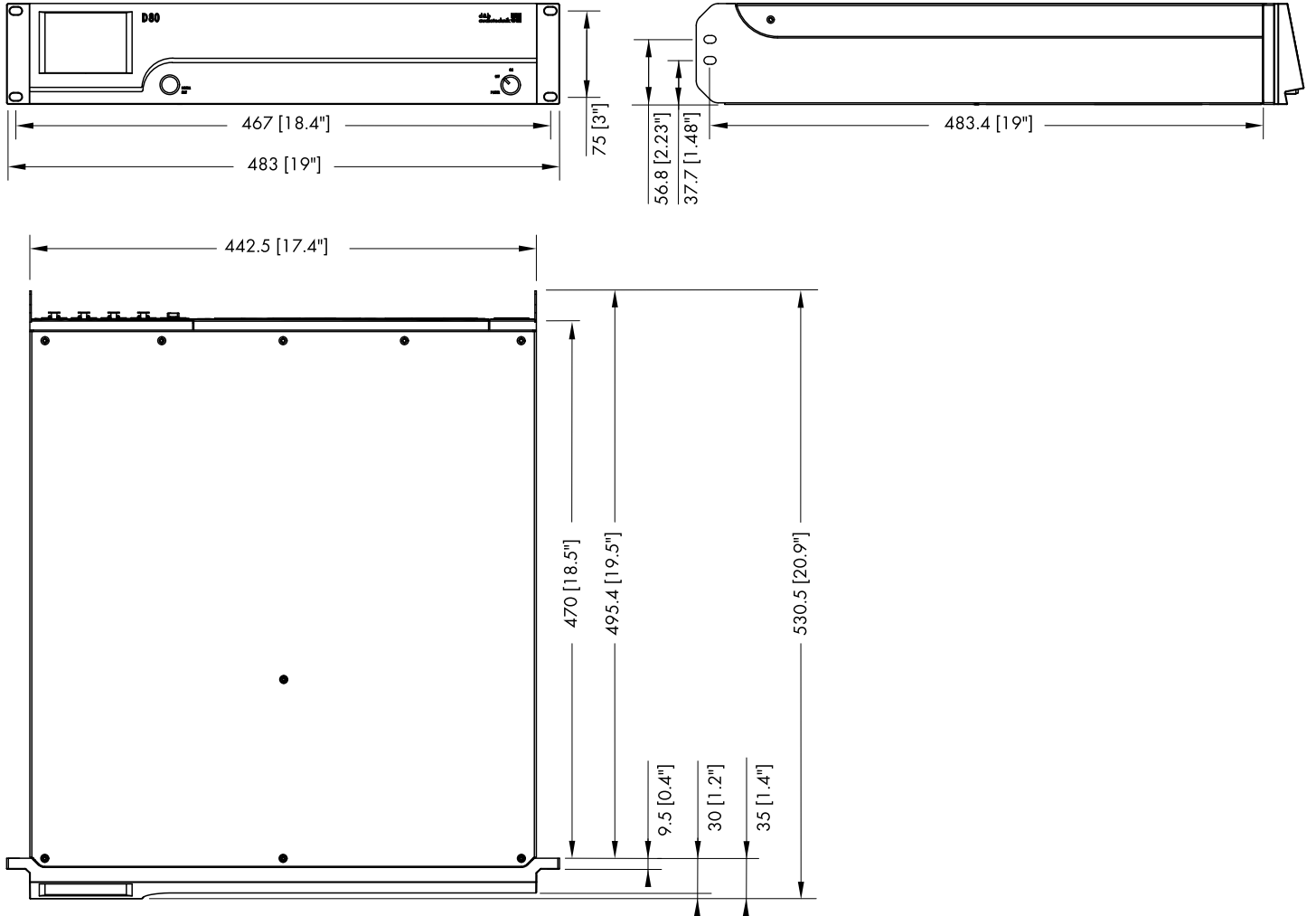

D80 enclosure dimensions in mm [inch]

3. Scope of supply

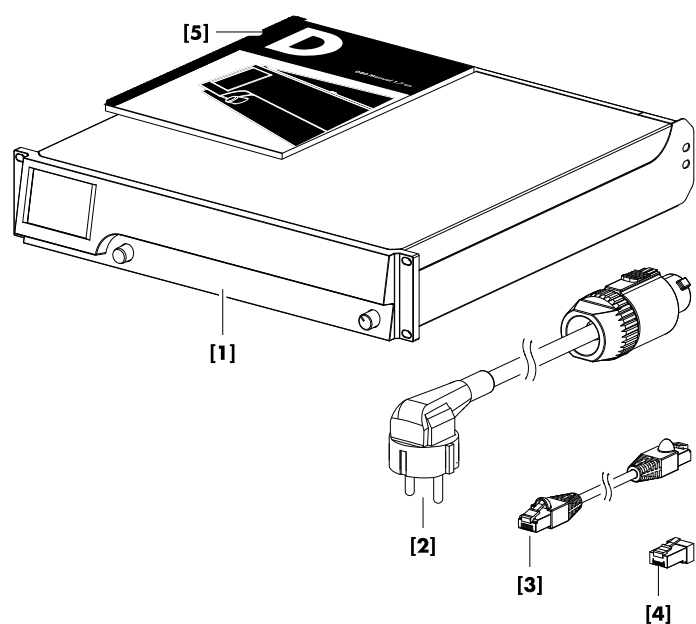

Before starting up the device, please verify the shipment for completeness and proper condition of the items.

If there is any sign of obvious damage to the unit and/or the power cord, do not operate the unit and contact your local dealer from whom you received it.

| Pos. | Qty. | d&b Code | Description |
|------------|------|--------------|---|
| [1] | 1 | Z2710 | d&b D80 Amplifier, dependent on chosen output option (NL4 or EP5 output connectors). |
| Including: | | | |
| [2] | 1 | Z2620.xxx | Power cord D80 (specific to country). |
| [3] | 1 | K6007.050 | RJ 45 Patch cable, 0.5 m (1.6 ft) CAT 6/AWG 24-STP (shielded twisted pair) to be used for daisy chaining multiple amplifiers within a rack. |
| [4] | 1 | Z6116 | RJ 45 M Terminator for terminating the last device of a CAN-Bus segment. |
| [5] | 1 | D2020.EN .01 | D80 Manual. |

4. Startup

4.1. Overview

Connections

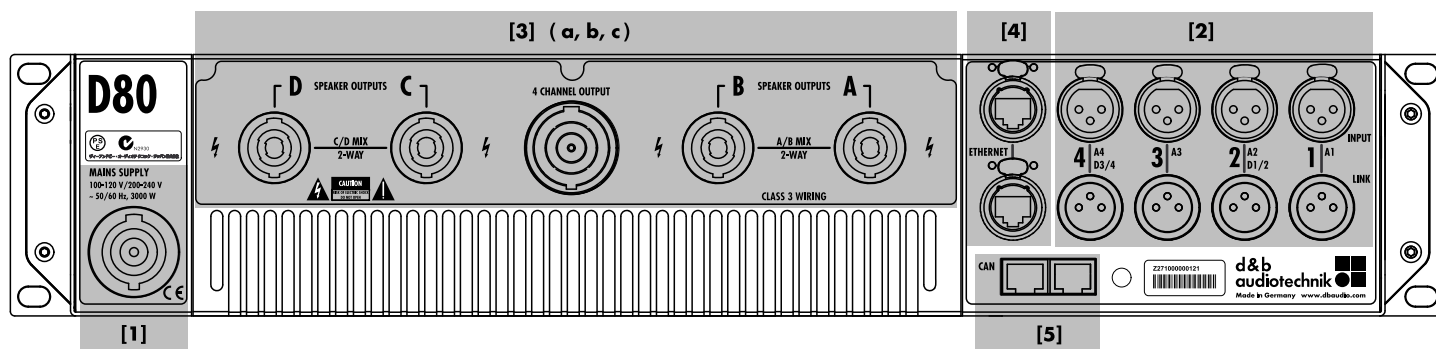

[1] Mains connector socket.
Refer to ⇒ Chapter 4.3.1. "Mains connection" on page 14 and ⇒ Chapter 1.3.1.5. "Mains supply requirements" on page 67.

[3] Output connector panel, dependent on chosen output option (NL4 or EP5 output connectors).
Refer to ⇒ Chapter 4.3.3. "Output connectors" on page 17.

[2] Audio INPUT (analog/digital) and LINK connectors.
Refer to ⇒ Chapter 4.3.2. "Audio INPUT and LINK connectors" on page 16.

[4] ETHERNET.
Refer to ⇒ Chapter 4.3.4. "ETHERNET (Dual Ethernet port)" on page 18.

[5] CAN (CAN-Bus).
Refer to ⇒ Chapter 4.3.5. "CAN (CAN-Bus)" on page 19.

Controls and indicators - User interface

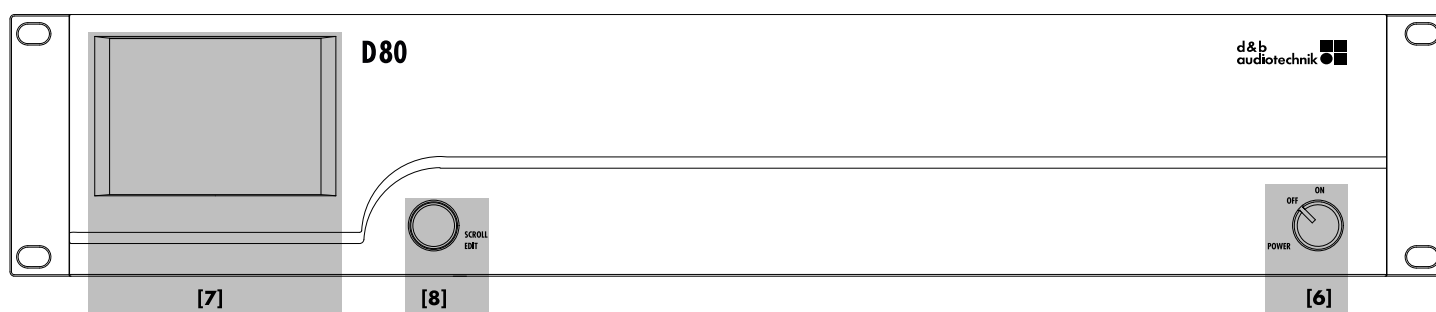

[7] 3.5" TFT color touch screen.
[8] Rotary encoder SCROLL/EDIT.
Refer to ⇒ Chapter 4.4. "Controls and indicators" on page 20 and ⇒ Chapter 5. "User interface" on page 23.

[6] Mains power switch.
Refer to ⇒ Chapter 4.4. "Controls and indicators" on page 20, following ⇒ Chapter 4.4.1. "Mains power switch" on page 20.

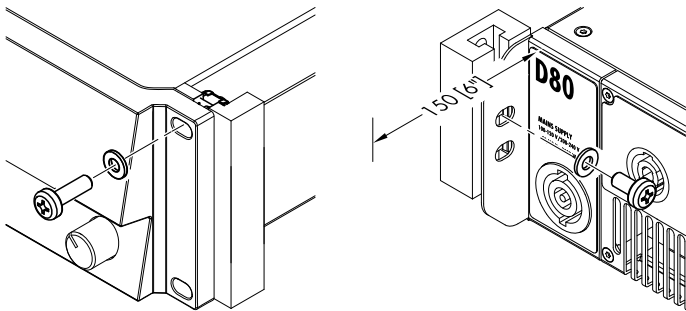

4.2. Rack mounting and cooling

Rack mounting

The D80 amplifier enclosure is designed to fit standard 19" equipment racks or cabinets.

When specifying a rack, be sure to allow extra depth (150 mm / 6" is usually sufficient) to accommodate the cables and connectors at the rear of the amplifier.

When mounting D80 amplifiers into a 19" rack, do not just rely on fixing and supporting the amplifiers by their front panels using appropriate rack mounting screws and U washers as shown in the graphic opposite. Provide additional support ...

- by fixing the rear-mounted rack ears using appropriate rack mounting screws and U washers as shown in the graphic opposite. This is particularly important when amplifiers are racked up for touring purposes.
- or using shelves fixed to the inner sides of the cabinet or rack.

Cooling

Thermal conditions are a vital factor to ensure operational safety of the power amplifiers. The D80 amplifier is equipped with three internal fans that draw cool air from the front into the housing and channel the warm air towards the back of the device.

- Please ensure that adequate cool airflow is provided.
- Do not block or cover the front panel air intake or the vents on the rear panel.
- If amplifiers are installed in sealed cabinets (e.g. in fixed installations), use additional fan modules with filters that can be easily replaced without opening the sealed cabinets.
- Do not combine D80 amplifiers with D6 or D12 amplifiers in one rack.
- Do not rack up D80 amplifiers together with other devices producing additional heat with opposing airflows.

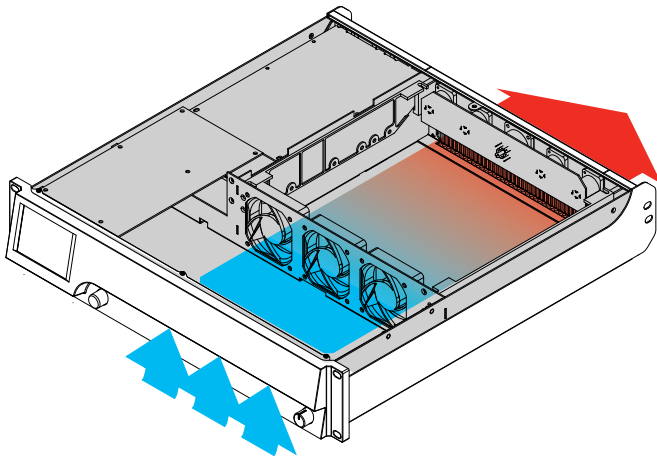

Base heat

Unlike other amplifiers, the D80 produces a base heat of approx: 40 °C (104 °F) in the rear part of the device when idling (On, idling). During operation, this temperature will only increase insignificantly. Please also refer to ⇒ Chapter 13.4. "Current/ power draw and thermal dissipation" on page 69.

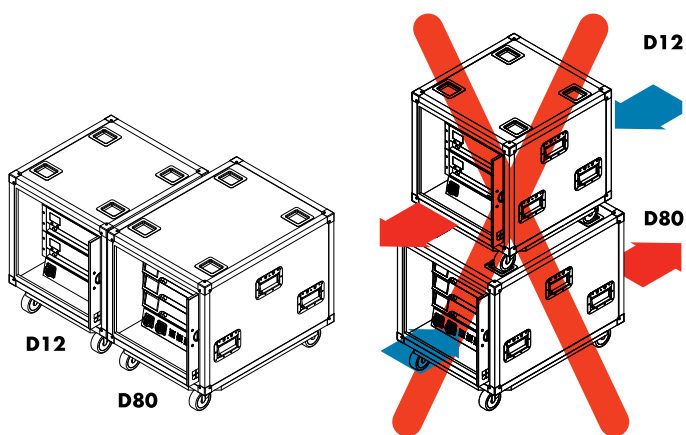
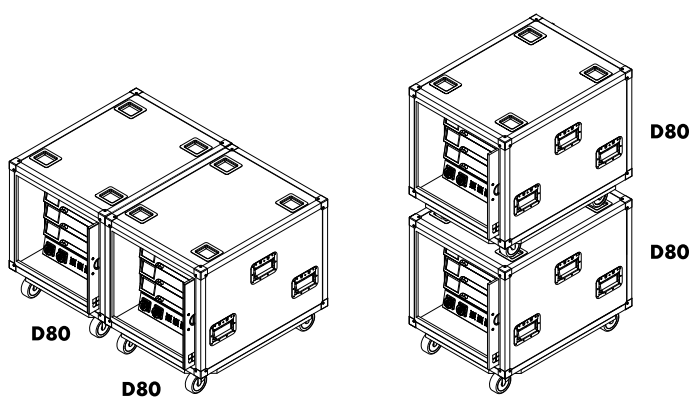
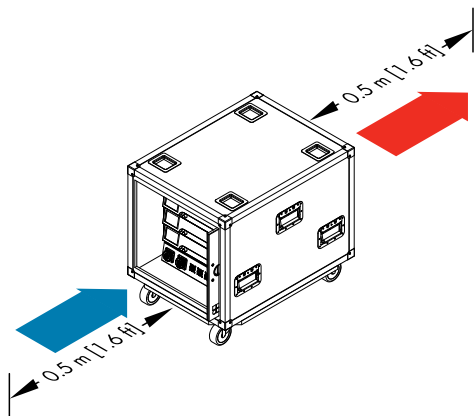

Touring rack assemblies

When using touring rack assemblies such as the d&b Z5330 D80 Touring rack assembly or any other touring rack containing D80 amplifiers, make sure to provide sufficient space of 0.5 m (1.6 ft) at the front and rear of the touring rack to ensure adequate cooling airflow.

When using touring rack assemblies such as the d&b Z???? D80 Touring rack assembly or any other touring rack containing D80 amplifiers, make sure to provide sufficient space of 0.5 m (1.6 ft) at the front and rear of the touring rack to ensure adequate cooling airflow.

D80 Touring rack assemblies can be positioned side by side or stacked.

When combining the Z5330 D80 Touring rack assembly with the Z5310 D12 Touring rack assembly or any other rack assembly that produces an opposing airflow, observe the following restrictions:

- D12/D80 Touring rack assemblies can be positioned side by side.
- Do not stack D80 and D12 Touring racks or any other rack assemblies with opposing airflow.

4.3. Connections

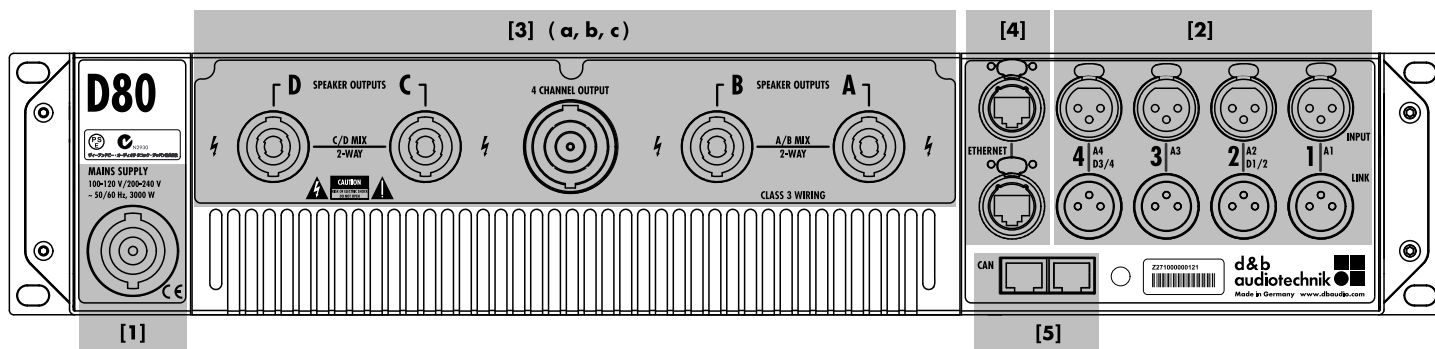

4.3.1. Mains connection



WARNING!

Potential risk of electric shock.

The amplifier is a protective class 1 unit. A missing earth (ground) contact may cause dangerous voltages in the housing and controls and may lead to electric shock.

- Connect the unit to mains power supplies with protective earth only.
- If there is any sign of obvious damage to the power cord and/or mains connector, do not use the power cord and replace it before further use.
- Please ensure the mains connector is accessible at any time to disconnect the unit in case of malfunction or danger. If the mains plug is not readily accessible due to mounting in a 19" rack, then the mains plug for the entire rack must be readily accessible.
- Do not connect or disconnect the powerCON® mains connector under load or live.

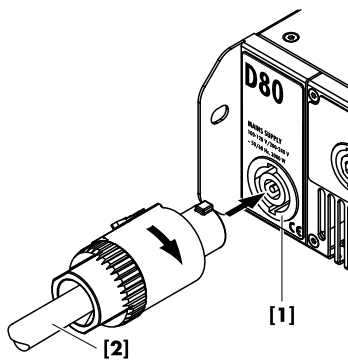
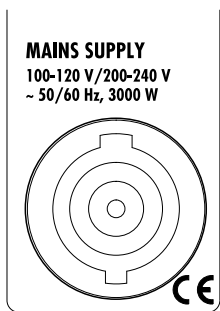

NOTICE!

Due to the high power capability of the device, only operate **one device per phase conductor**.

Please also refer to ⇒ Chapter 13.1. "Power supply" on page 66, following ⇒ Chapter 13.1.5. "Mains supply requirements" on page 67.

| Mains voltage | Frequency | Current |
|---------------|-----------|-----------|
| 100/120 V | 50/60 Hz | 30 A |
| 230/240 V | 50/60 Hz | 15 - 16 A |

Before connecting the device to mains voltage, check that the mains voltage and frequency correspond to the specifications on the rating label above the mains connector socket on the rear panel of the unit.

A powerCON-HC® mains connector socket **[1]** is fitted on the rear panel and an appropriate power cord **[2]** is supplied.

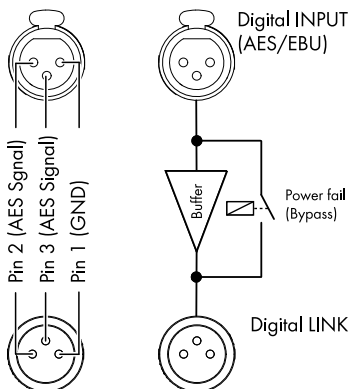
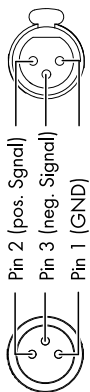
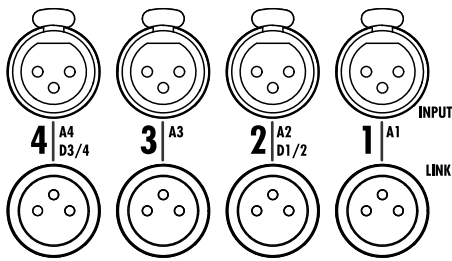

4.3.2. Audio INPUT and LINK connectors

All signal input and link output connectors 1-4 are located on the rear panel.

These can be configured as four analog inputs, two analog and two AES channels or four AES channels (Please refer to ⇒ Chapter 9.2. "Input" on page 34).

Each input channel can be routed to any of the output channels A to D (Please refer to ⇒ Chapter 10.6. "Input routing" on page 55).

Analog INPUT and LINK (A1 - A4)

A 3-pin female XLR input connector is provided for each channel. Wired in parallel is a 3-pin male XLR input link connector used to feed the input signal on to the next device in the signal chain.

Specifications

| | |
|---|-----------------------------------|
| Pin assignment..... | 1 = GND, 2 = pos., 3 = neg. |
| Input impedance..... | 38 kOhms, electronically balanced |
| Common mode rejection (CMRR@100 Hz/10 kHz)..... | > 70/50 dB |
| Maximum input level (balanced/unbalanced)..... | +25/17 dBu |
| | +27 dBu @ 0 dBFS |
| LINK analog (A1 - A4)..... | 3 pin XLR male |
| | parallel to input |

Digital INPUT and LINK (D1/2 - D3/4)

The input connectors 2 (D1/2) and 4 (D3/4) can be configured as AES/EBU (AES 3) inputs individually.

Note: When configuring the digital inputs, the remaining input and link output connectors 1 (A1) and/or 3 (A3) are disabled.

The corresponding digital LINK output (2/4) can be used to feed a refreshed input signal to the next device in the signal chain. The signal shape (the rising and falling edges of the signal) and level are refreshed with an analog buffer amplifier.

A power fail relay is incorporated to prevent interruption of the signal chain should there be a power failure. In this situation, the digital input signal bypasses the analog buffer amplifier and is routed directly to the LINK output.

Specifications

| | |
|----------------------------|--|
| Pin assignment..... | 1 = GND, 2 = AES Signal, 3 = AES Signal |
| Input impedance..... | 110 ohms, transformer balanced |
| Sampling..... | 48 / 96 kHz / 2 Ch/n |
| Synchronization..... | Word-Sync: PLL-locked to source (slave mode) |
| LINK digital (Output)..... | 3-pin XLR male |
| | electronically balanced |
| | analog signal buffering (refresh) |
| | Power Fail Relay (Bypass) |

4.3.3. Output connectors

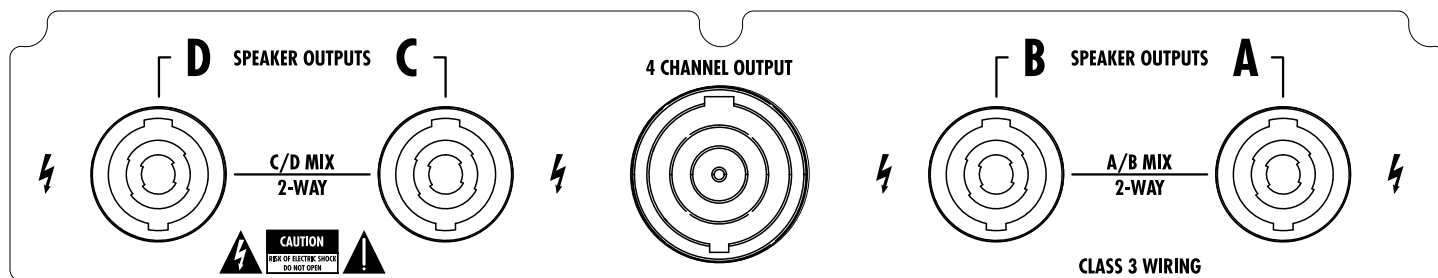

WARNING!
Potential risk of electric shock.

The amplifier's output pins can carry dangerous voltages.

- Only use isolated loudspeaker cables with correctly fitted connectors.
- Never connect an amplifier output pin to any other input or output connector pin or protective earth (ground).

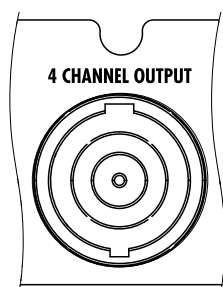
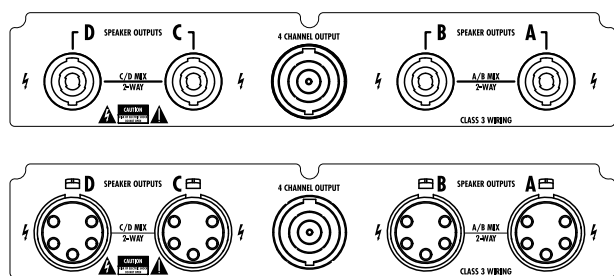

SPEAKER OUTPUTS

Depending on the chosen output option, the amplifier is supplied with four NL4 or EP5 output connectors, one for each amplifier output channel.

Depending on the output mode selected, the appropriate pin assignment of the relevant output connectors is set automatically.

Note: A detailed description of the applicable output modes and how to configure the appropriate output mode is given in \Rightarrow Chapter 9.3.1. "Output mode" on page 37.

For further information regarding the applicable output modes for each loudspeaker system, please refer to the relevant loudspeaker manual.

4 CHANNEL OUTPUT

NOTICE!

The 4 CHANNEL OUTPUT connector is only intended as an interface to a rack panel or to loudspeaker multicores and breakout adapters.

Do not connect any loudspeaker cabinets, neither passive nor active systems, to this connector, otherwise there is a risk of damaging the loudspeaker components or the amplifier.

The centered NL8 connector carries the output signals of all four amplifier channels with the following pin assignment:

| | |
|------------------------------|------------------------------|
| 1+/- = Channel A pos. / neg. | 2+/- = Channel B pos. / neg. |
| 3+/- = Channel C pos. / neg. | 4+/- = Channel D pos. / neg. |

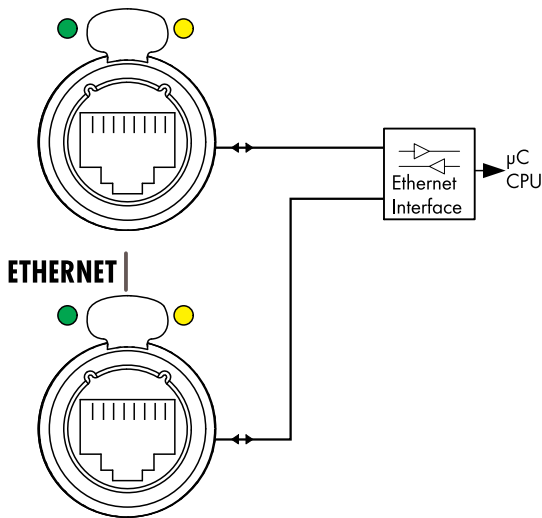

4.3.4. ETHERNET (Dual Ethernet port)

A Dual Ethernet port with a built-in 2-port Ethernet switch (10/100 Mbit/peer-to-peer) is provided enabling remote control via Ethernet and allows the following physical network topologies:

- Star topology - **recommended**,
- Daisy chain topology,
- or a combination of both topologies.

Note: In a daisy chain topology, if one device fails or is switched off, this also affects all subsequent devices which are then no longer connected to the network either.

A detailed description of remote control via Ethernet is given in the technical information TI 310 (d&b code D5310.EN) which can be downloaded from the d&b website at www.dbaudio.com.

LED indicators

The two LED indicators above the respective connector in use indicate the following states:

- Green** Illuminates permanently when the device is connected to an active network and flashes as long as a data stream is transmitted.
- Yellow**
 - Is off when the speed is 10 Mbit.
 - Illuminates permanently when the speed is 100 Mbit.

Network topologies

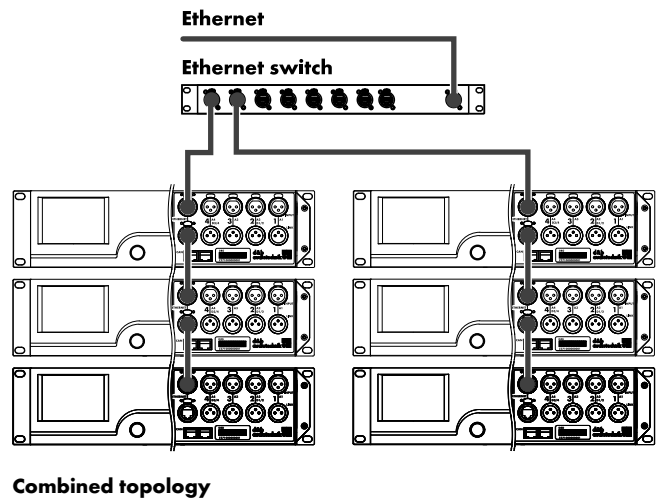
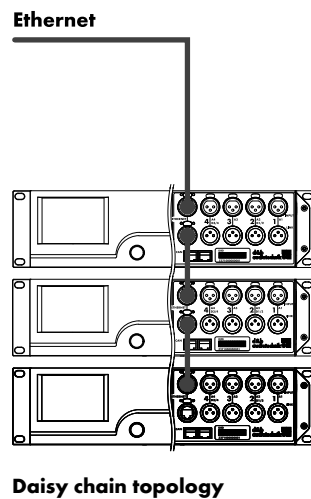
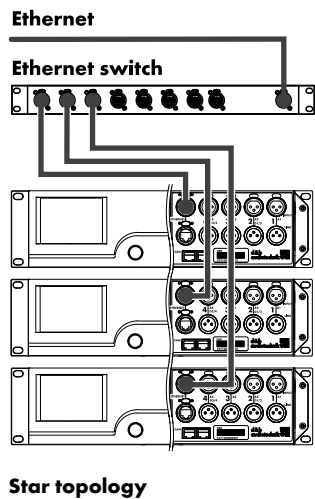

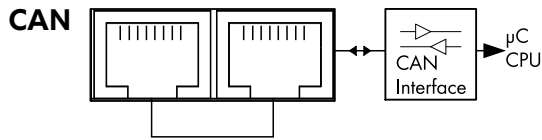

4.3.5. CAN (CAN-Bus)

The device is equipped with a 2-wire serial remote control interface carrying the CAN-Bus signals to enable remote control with the d&b R60 USB to CAN or R70 Ethernet to CAN interfaces.

Note: A detailed description of remote control via the d&b Remote network (CAN-Bus) is given in the technical information TI 312 (d&b code D5312.EN) which can be downloaded from the d&b website at www.dbaudio.com.

All pins of both RJ 45 connectors are wired in parallel allowing either to be used as input or output. When remote control networking conforms to a "Bus or Ring topology", one connector is used for the incoming signal and the second connector allows for direct connection to another device (daisy chaining) or for terminating the CAN-Bus network.

Pin assignment

The pin assignments of both, the RJ 45 sockets and the cable connectors, are shown in the graphic opposite.

Note: The connections for the CAN-Bus are referenced to common ground. The "**CAN Ground**" is routed **via the cable shielding** and it its hardwired to PE.

Within the CAN-Bus network, shielded cables and shielded RJ 45 connectors (metal housing) must be used while the cable shielding must be connected to both sides of the RJ 45 connector.

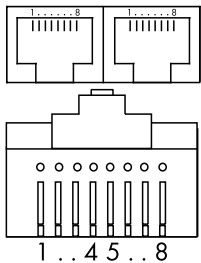

Pin 1: n.c.

Pin 2: n.c.

Pin 3: n.c.

Pin 4: CAN_H(igh) line

Pin 5: CAN_L(ow) line

Pin 6: n.c.

Pin 7: n.c.

Pin 8: n.c.

Shield: CAN Ground (PE)

4.4. Controls and indicators

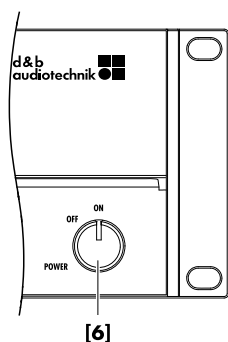
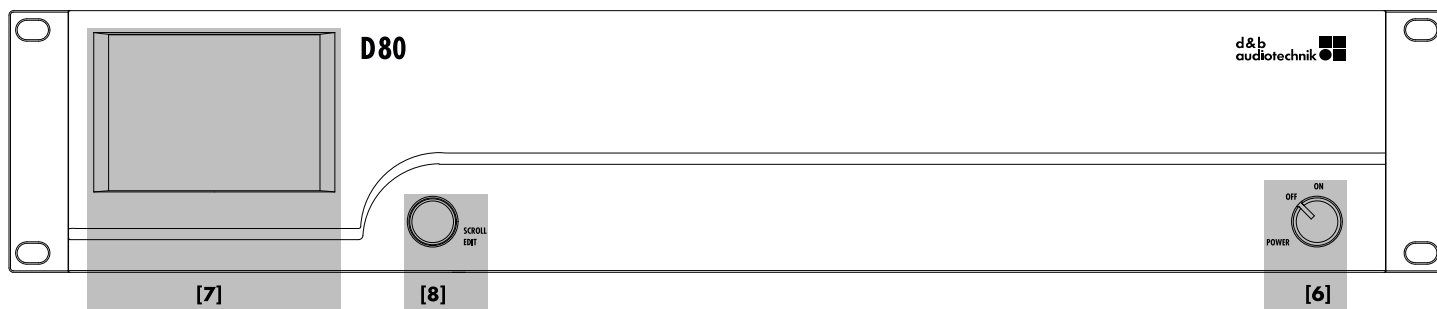

4.4.1. Mains power switch

The on/off rotary switch [6] is located on the bottom right of the front panel.

- OFF** Mains isolation is not provided. The internal power supplies are off but stay connected to the mains.
- ON** The unit is switched on and ready for operation.

4.4.2. Display - User interface

Operation, configuration and status viewing are all performed via the Display ⇒ User interface.

The user interface consists of a 3.5" TFT color touch screen [7] with a resolution of 320 x 240 pixels and an additional digital rotary encoder [8].

The resistive touch screen responds to pressure and therefore can be operated by a fingertip, even when wearing gloves, or by an appropriate stylus tip (pen).

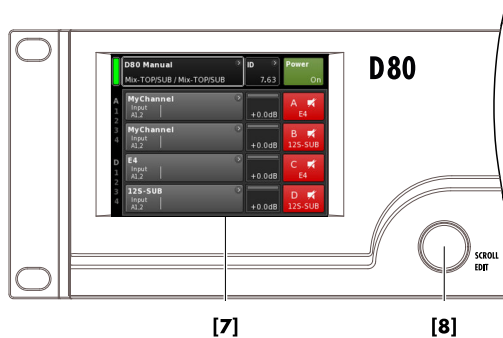

NOTICE!

The touch panel utilizes a thin flexible sheet that may be damaged by sharp objects or heavy treatment.

Due to the wide range of functions the user interface is described separately in more detail in ⇒ Chapter 5. "User interface" on page 23.

However, both the Standby and Mute functions of the D80 are described in the following two sections.



4.4.3. Standby mode

To switch the device to Standby mode ... :

1. Tap the «Power» button on the top right of the Home screen. A dialog appears allowing you to either select the Back button (⌂ - cancel), «Mute all» or «Standby».
2. Select «Standby».

When the device is in Standby mode, both the «Power» button on the right and the green Power on indicator on the left are switched off. In addition, on the Device view button, Standby flashes alternating with the Device name.

Note: In Standby mode, the user interface of the device is still operable.

3. To repower the unit, tap the «Power» button. Startup time from Standby state is <1 sec.

The operating state (Standby active) is stored when the «Power» button is set to "Off" and is restored when the «Power» button is set back to "On" again.

In Standby mode, the main power supply and the power amplifiers are switched off to save energy and the loudspeaker outputs are electronically isolated. The display and controls remain active to allow repowering of the device by remote control or by tapping the «Power» button on the Home screen.

Note: When the device is set to Standby (or the mains power is switched off), the movement of the loudspeaker cones in the connected cabinets is no longer damped by the power amplifier output. This removal of the damping makes them susceptible to excitation by other loudspeakers in the surroundings. Audible resonances may occur, and even absorption of low frequency sound energy as the undamped loudspeakers act like a "bass trap".

To permanently mute single subwoofer cabinets while others are operated at the same time it is therefore preferable to use the Mute function instead of Standby. However, the Standby mode can be useful with mid/high systems as it removes any residual noise from the system.

4.4.4. Mute functions

The D80 provides two mute functions:

- Individual mute buttons for each channel or pair of channels
⇒ Channel mute,
- and a master mute function ⇒ «Mute all».

Note: The device stores the setting of the mute buttons when the mains power is switched off or disconnected. When the unit is switched on or reconnected, it will return to its pre-disconnection status.

Channel mute

- ⇒ To mute or unmute a single channel or a pair of channels, simply tap the respective Channel mute button.
- ⇒ The Channel mute button displays the mute status of the relevant channel or pair of channels and the loudspeaker setup loaded.

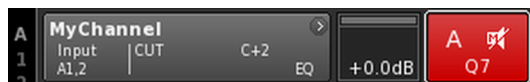

Channel muted

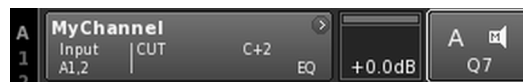

Channel unmuted

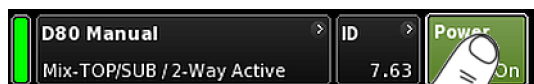

Master mute («Mute all»)

1. To mute all channels simultaneously, tap the «Power» button on the top right of the Home screen.
 - ⇒ A dialog appears allowing you to either select the Back button (⏪ - cancel), «Mute all» or «Standby».
2. Select «Mute all».
 - ⇒ To unmute the channels, use the individual Channel mute buttons.

5. User interface

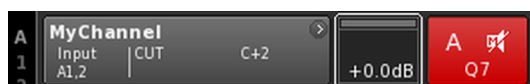
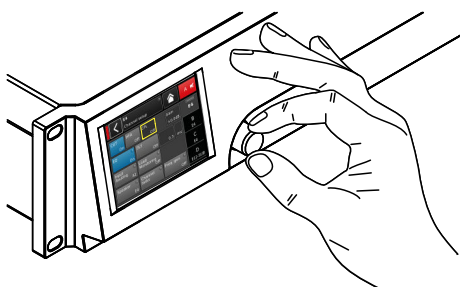
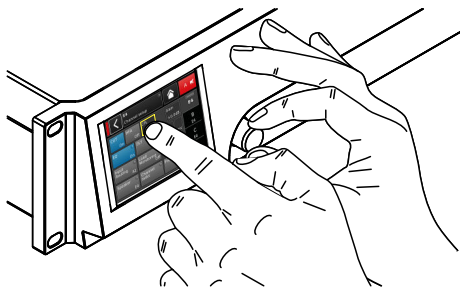

5.1. Operating concept

The operating concept allows different methods of interaction and configuration.

Touch screen in combination with the rotary encoder

This method may preferably be used to define values of input fields such as Gain settings, CPL, Delay or EQ settings.

- Select menus, menu items and/or function elements by tapping the relevant item.
- Enter/edit values by turning the encoder.
- Confirm entered/changed values by tapping the respective item or confirmation button («OK») or pushing the encoder.

Rotary encoder only

This method is mainly intended for users who are familiar with the user interfaces of other d&b amplifiers.

- Select menus, menu items and/or function elements by turning the encoder to move the Position cursor to the relevant item.
- Access the selected item or function element by pushing the encoder.
- Enter/edit values by turning the encoder.
- Confirm entered/changed values or leave Edit mode by pushing the encoder.

Cursor conventions

The graphical user interface features two types of cursors, the Position and the Edit cursors.

Position cursor

The Position cursor marks the selected Menu item by a white frame. Depending on the type of screen item, the Position cursor allows you to either activate a function, navigate through the menu or enter Edit mode ⇒ Edit cursor.



Edit cursor

In Edit mode, the Edit cursor is marked by a yellow frame. Turning the encoder to the right (clockwise) increases the current value, turning the encoder to the left (counterclockwise) decreases it.



To leave Edit mode press the encoder or simply tap the respective Menu item again. The color of the frame will change from yellow back to white again ⇒ Position cursor.

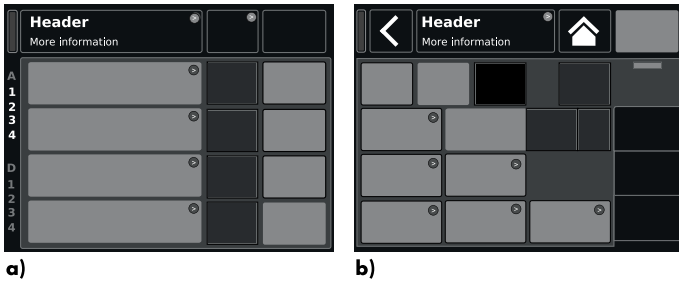



Basic screen layout

- a) Home screen
- b) Device and Channel setup screens

5.2. Screen layout and conventions

The screen layout is split into two main parts, the Header and the Data sections.

Header The Header (Headline) indicates which screen is currently selected. In the Device and Channel setup screens, the Header allows direct access to the previous screen (Back button - ) or to the Home screen (Home button - ) .

Data Except for the Home screen, the Data sections of the Channel and Device setup screens are structured in tabs on the right hand side of the screen. The tabbed structure of the screens allows you to directly access the desired subscreens.

5.3. Screen items and views

This section describes the different menu items, views and function elements characterizing the user interface of the D80.

5.3.1. Function buttons

Properties:

- The top left of the button shows the function name while the bottom right shows the status of the function. In addition, the status is also indicated by colors.
- The function is activated by tapping the button on screen or pushing the encoder.
- Functions buttons can also be combined with navigation buttons.

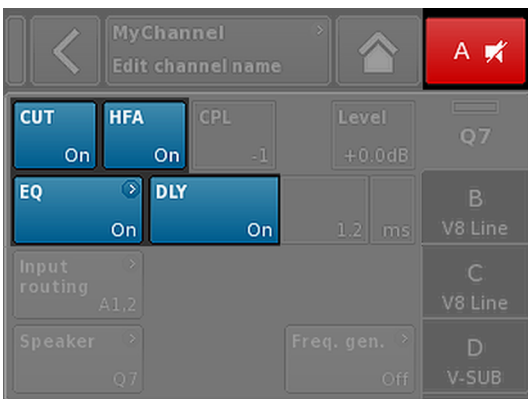

5.3.2. Navigation buttons

Properties:

- The top right of the button shows the navigation symbol () .
- Open the related subscreen by tapping the button on screen or pushing the encoder.





5.3.3. Input fields

Properties:

- The top left of the button shows the field name while the bottom right shows the value. The value can be edited.
- Select the value by tapping the button on screen or pushing the encoder.
- Edit the value by turning the encoder.

Note: The set value will be applied directly.



5.3.4. Input masks

Properties:

- Appears automatically anytime you need to enter data to define a particular function. The input mask provides you with an alphanumeric or numeric keypad to enter, for example, a device name or a channel name (alphanumeric keypad) or an IP address (numeric keypad).
- Selection and editing is performed using the touch screen or turning and pushing the encoder.

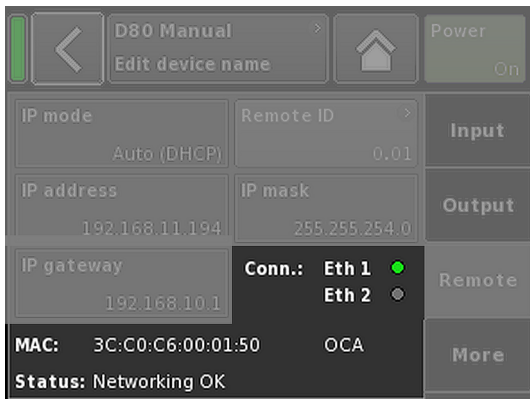

5.3.5. Information fields

Properties:

Non-selectable/non-editable field for information purposes only.

6. Home screen

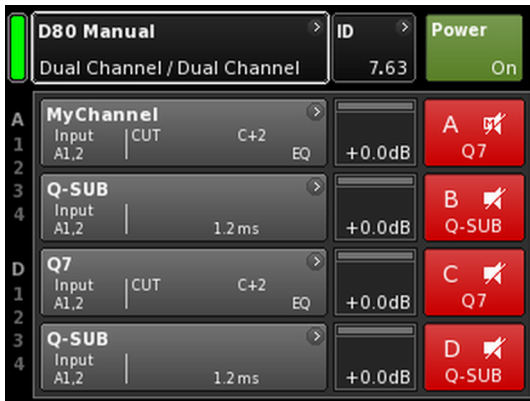

From the Home screen, the menu structure of the operating software is divided into two main axes, the Device setup and the Channel setup. The navigation buttons allow for direct vertical access to the specific submenus while the tab structure on the right side of each submenu provides a clear horizontal order.

In addition, the Home screen gives direct access to the Remote subscreen.

The Home screen can be accessed from any screen or menu at any level using the Home button (🏠).

Home screen access chart
Hierarchy level

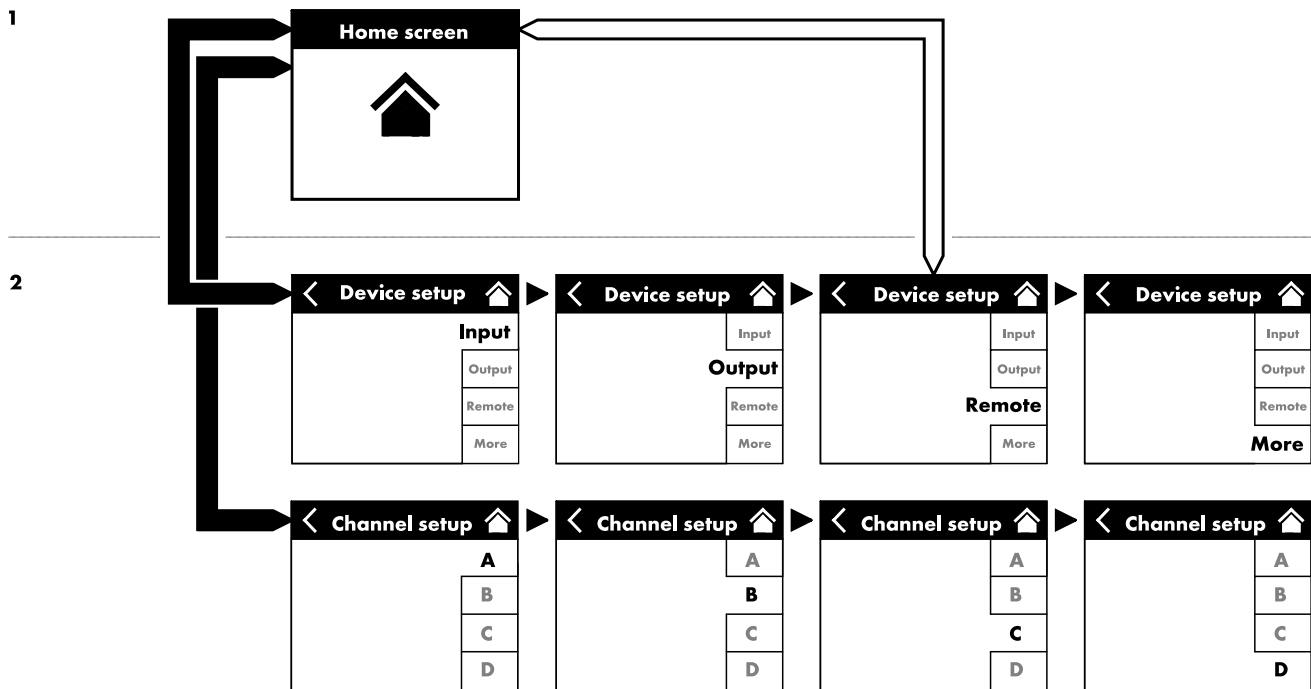

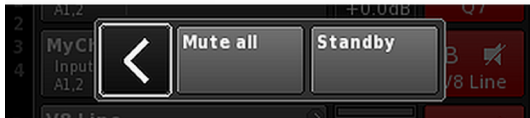
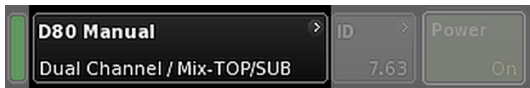

6.1. Header area - Device

(from left to right):

Power on indicator

Yellow Indicates the start up phase of the power supply.

Green Indicates that the unit is switched on.

Red Indicates a device error.

Device view button

The device name and the output mode are displayed. This button provides direct access to the Device setup screen.

ID

The Remote «ID» is displayed. This navigation button also provides direct access to the Remote subscreen.

Power button

The «Power» button provides the following functions:

 Cancel the sequence.

Mute all Master mute.
To unmute the channels, use the individual Channel mute buttons.

Standby In Standby mode the device idles drawing minimal power consumption. Only the most essential functions are provided. The screen and network remain functional.

6.2. Data area - Channel strip(s)

The data area features the actual channel strips starting with the input connector and then following the real signal flow from left to right. All vital information is displayed. This includes:

- Input signal present (ISP)
- Input routing
- Channel configuration,
- Controller output signal (OSP)
- Channel mute buttons and status.
- Error messages

7. Channel strip

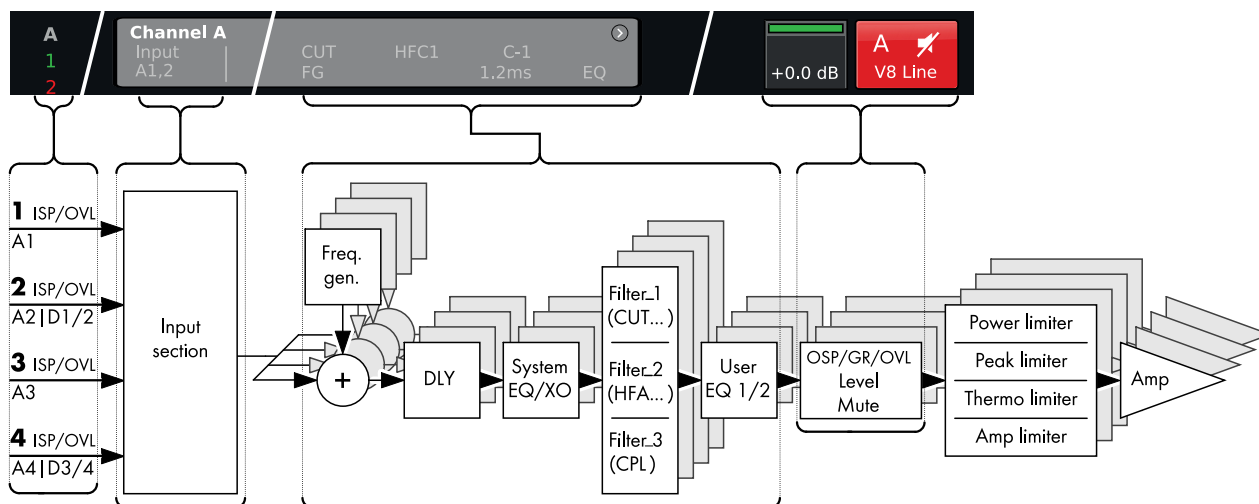

D80 Channel strip block diagram (signal chain)

The channel strip follows the actual signal chain from left to right:

ISP/OVL

Indicates the following states for both, the analog (**A**) and the digital (**D**) signal inputs:

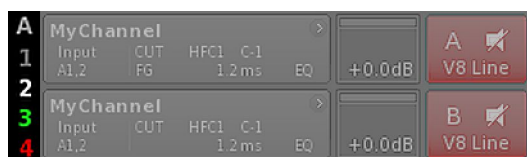

Grey

The relevant channel is not available.

White

The relevant channel is available and an input signal is not present or below -30 dBu.

Green

ISP (Input Signal Present): Illuminates when the analog input signal exceeds -30 dBu or when the digital input is locked to 48 or 96 kHz and the signal exceeds -57 dBFS.

Red

OVL (Overload): Illuminates when the analog input signal exceeds 25 dBu or when the digital input signal exceeds -2 dBFS.



Channel view

The Channel view button displays the Channel name. If no Channel name has been entered, the loudspeaker setup which is currently loaded is displayed. In addition, the activated function elements are indicated. The button provides direct access to the \Rightarrow Channel setup screen.

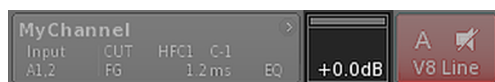

Level

The Level input field allows direct setting of the amplifier's relative input sensitivity in the range of -57.5 dB to $+6$ dB in steps of 0.5 dB.

In addition, the following indicators are available:



ISP/OSP/GR/OVL

Indicates whether the DSP receives an input signal and whether the DSP output signal is present (provided the channel is not muted).

- Grey** No signal present.
- Dark green:** Channel input signal present (ISP).
- Bright green:** Controller (DSP) output signal present (OSP).
- Yellow** **GR (Gain Reduction):**
Illuminates when one limiter reduces the signal by a predefined level (GR ≥ 3 dB).
- Red** **OVL (Overload):**
Illuminates when ...:
 - any signal within the channel exceeds -2 dBFS.
 - DSP suffers from an internal EQ filter overflow.
 - any limiter causes a gain reduction of 12 dB or more.
 - the output signal is limited to prevent distortion due to output peak current overload of >70 A.



Channel mute

- ⇒ To mute or unmute a single channel or a pair of channels, simply tap the respective Channel mute button.
- ⇒ The Channel mute button displays the mute status of the relevant channel or pair of channels and the loudspeaker setup loaded.



Channel muted

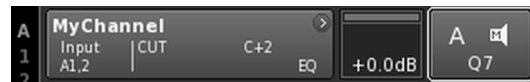

Channel unmuted



A channel error is indicated on the Channel mute button by an exclamation mark ⇒ .

A corresponding error message is issued on the Channel view button.

8. Basic settings - Quick reference

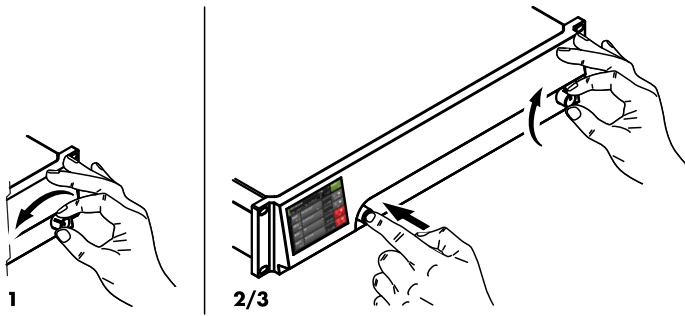

Due to the vast functional range and possible settings of the D80 amplifier, this section is intended as a quick reference to provide you with a systematic procedure for defining the basic settings of the amplifier.

It is advisable to start with the device settings followed by the individual channel settings.

System reset

Before starting to define the basic settings, perform a system reset.

1. Switch off the device.
2. Press and hold the encoder and repower the device.
⇒ Long confirmation beep.
3. Release the encoder and briefly press the encoder again within 2 sec.
⇒ Short confirmation beep.
The device will boot up and will switch to the Home screen. A corresponding message will be issued:

All device settings have been cleared

1. Device setup

- ⇒ On the Home screen, tap the Device view button.
- ⇒ This will enter the Device setup subscreen with the «Input» tab being active.



2. Input (Input mode / Input routing)

- ⇒ Define your Input mode and Input routing settings for all channels correspondingly.

Note: A detailed description of the Input routing is given in the reference chapter of the Channel setup ⇒ Chapter 10.6. "Input routing" on page 55.

A detailed description of the Input mode is given in the reference chapter ⇒ Chapter 9.2. "Input" on page 34.

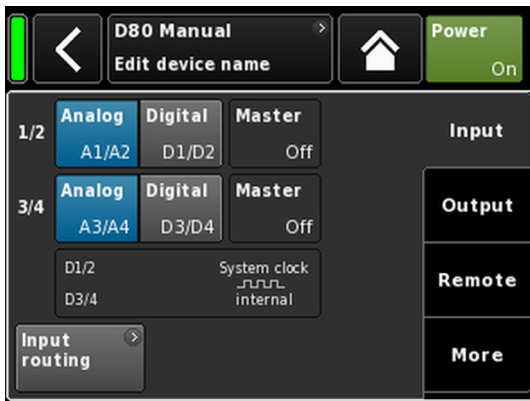

3. Output (Output mode)

- ⇒ Tap the «Output» tab and define your desired output mode settings for each pair of amplifier channels correspondingly.

Note: A detailed description of the available output modes is given in the reference chapter ⇒ Chapter 9.3. "Output" on page 36

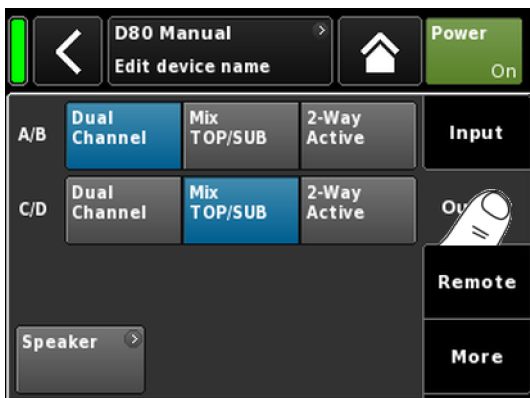

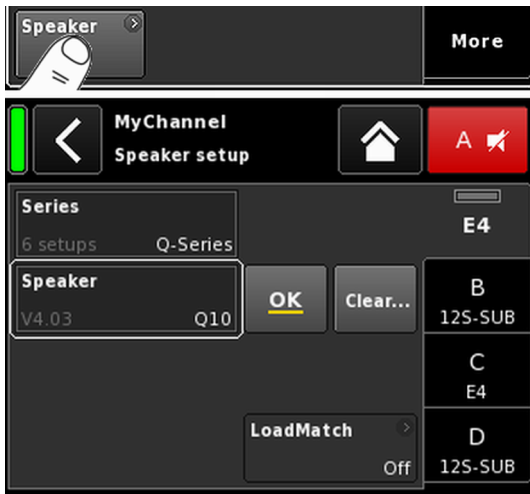

Speaker

1. On the bottom left of the «Output» tab, select the «Speaker» navigation button to enter the Speaker setup subscreen.
2. Choose the desired speaker setups for all channels and confirm each selected setup by tapping the «OK» button right next to the «Speaker» selection field.
3. Define the LoadMatch settings, if applicable and desired, correspondingly.
4. After defining all settings, exit the subscreen by tapping the Home button (🏠).

Note: A detailed description of the Speaker setup and LoadMatch settings is given in the reference chapter ⇒ Chapter 10.7. "Speaker" on page 56.



4. Remote

1. On the Home screen, tap the Device view button to enter the Device setup menu.
2. Tap the «Remote» tab and define your desired Remote settings correspondingly.

Note: A detailed description of the remote settings is given in the reference chapter ⇒ Chapter 9.4. "Remote" on page 41.

As all the configurations and settings mentioned above can also be defined remotely, it depends on how you wish to proceed whether defining the Remote settings is the last or the first step when configuring your basic settings.

After defining all settings, exit the subscreen by tapping the Home button (🏠) and carry on with the individual channel settings.



5. Channel setup

1. On the Home screen, tap the Channel view button of the first channel (A) or pair of channels (A/B) to enter the Channel setup.
2. Define your individual channel settings such as CUT, HFA, CPL, Level, DLY or EQ for all channels correspondingly.
3. After defining all settings, exit the subscreen by tapping the Home button (🏠).

Note: A detailed description of the Input routing is given in the reference chapter ⇒ Chapter 10.6. "Input routing" on page 55.

A detailed description of the Input mode is given in the reference chapter ⇒ Chapter 9.2. "Input" on page 34.

9. Device setup

Device setup access chart

Hierarchy level

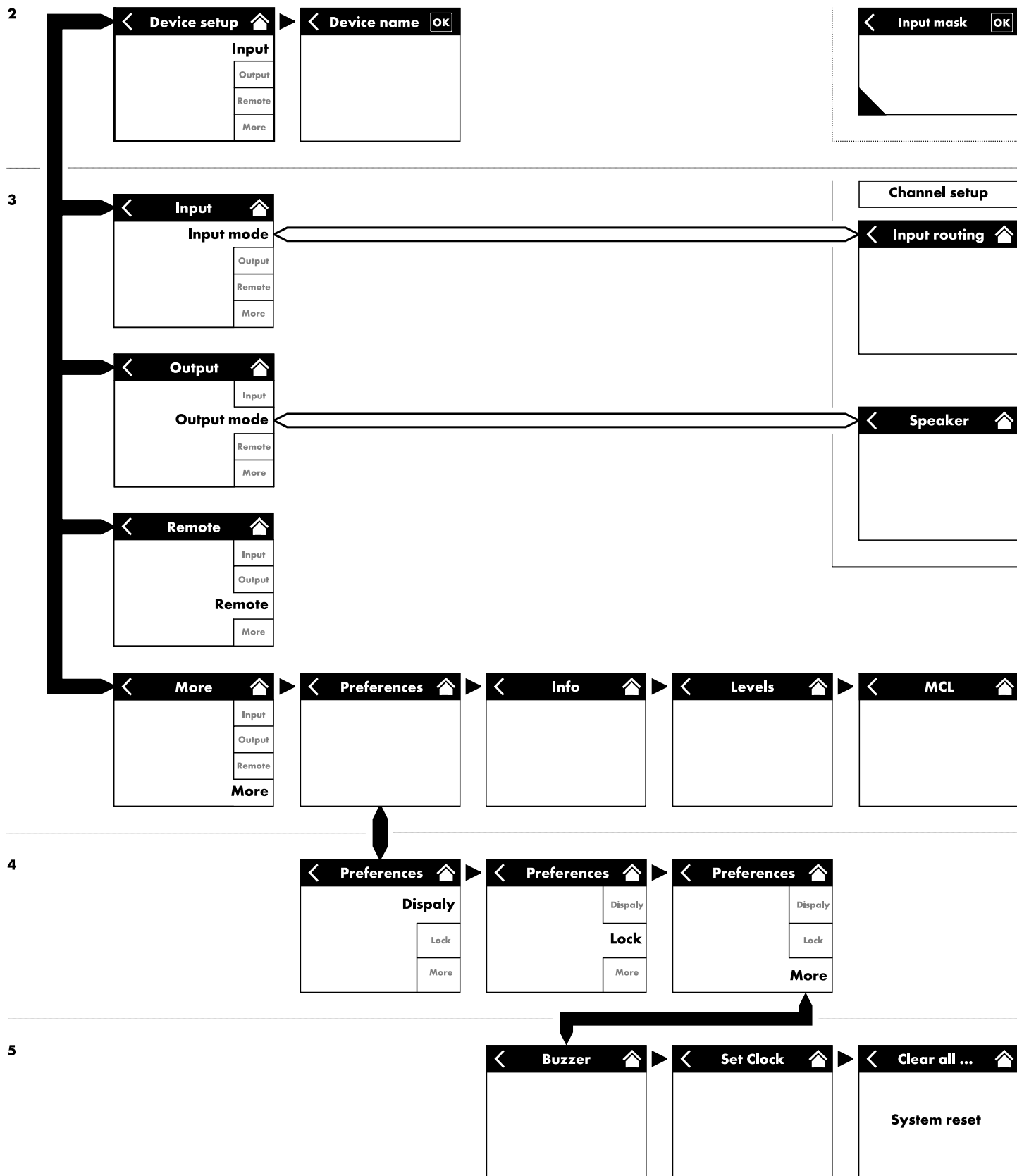



From the Home screen, selecting the Device view button opens the Device setup screen with the «Input» tab being active.

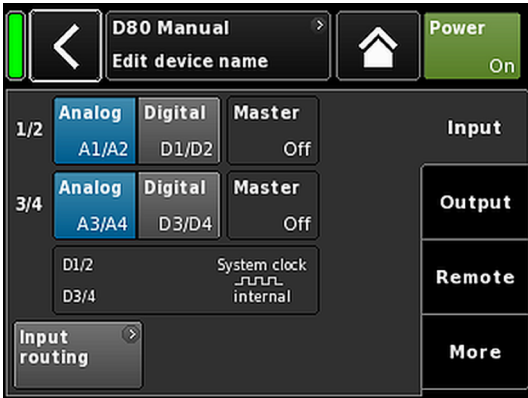

The Device setup screen follows the same layout structure as described above and is split into the Header and the Data sections.

Using the tabbed structure of the Device setup screen provides direct access to the desired subscreens.



9.1. Device name

Selecting the centered Information field button («Edit device name») in the header of the device setup screen enables you to enter or edit the device name (maximum length 15 characters).



The input mask which appears allows either lower-case or upper-case characters by toggling the corresponding button («abc») on the bottom left.

Wrong entries can be corrected by tapping the Erase button (⌫) on the bottom right.

Tapping «OK» on the top right confirms the entry, closes the input mask and switches back to the Device setup screen.

Tapping the Back button (⏪) on the top left cancels any entry and switches back to the Device setup screen keeping the previous entry.

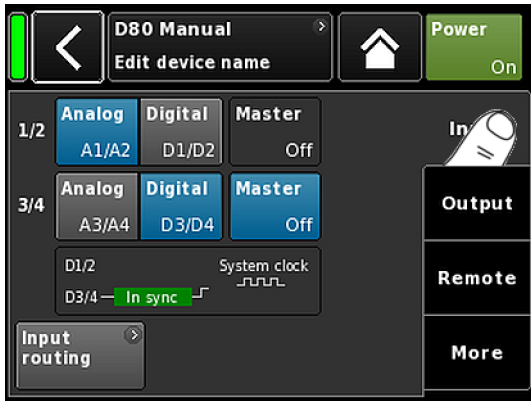

9.2. Input

Selecting the «Input» tab allows you to configure the Input mode for the input connector pairs 1/2 and 3/4 independently to accept either analog or digital input signals.

The operating mode of the corresponding link output connectors 2 and 4 depends on the set input mode.

9.2.1. Input mode

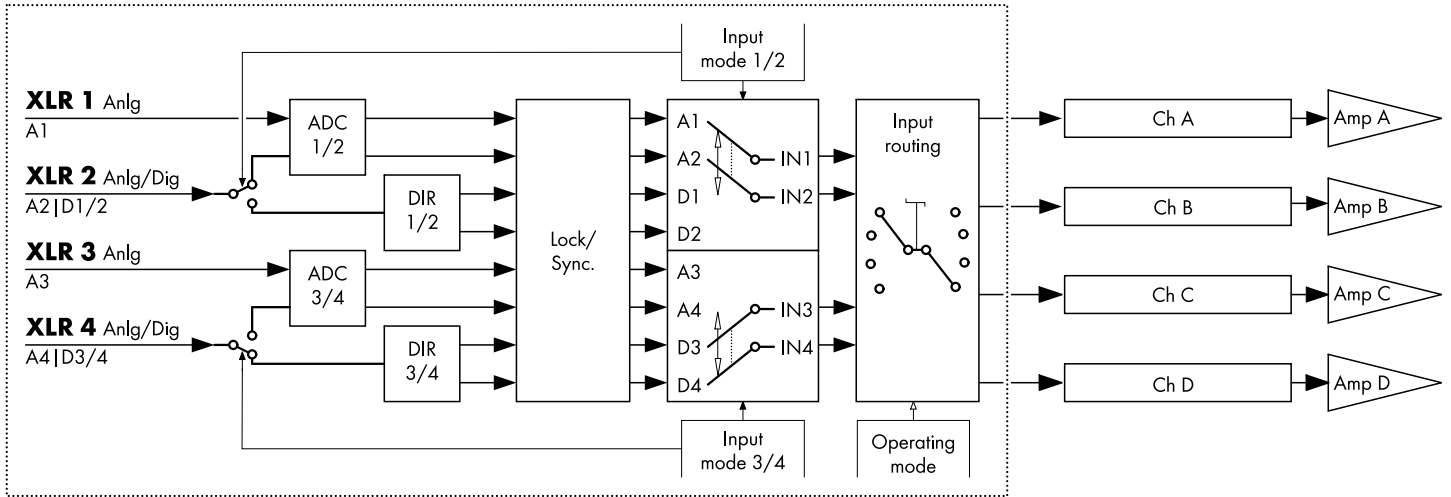

Input mode block diagram



Analog/Analog

Both input connector pairs 1/2 and 3/4 are set to «Analog», an analog audio signal is accepted by inputs 1, 2, 3 and 4.



Digital/Digital

Both input connector pairs 1/2 and 3/4 are set to «Digital», a 2-channel digital audio signal is accepted by inputs 2 and 4 respectively.

The input connectors 1 and 3 are not available.

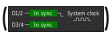
Locking to either 48 or 96 kHz is indicated below (). In this case, the sync source is input 2.

When both input pairs are set to «Digital», either of them can be selected as sync source.

Note: When both input pairs are set to «Digital» and locking to the sync source is not possible, none of the inputs will receive an audio signal.

If two digital signals are used at the same time, these signals must be completely synchronous (i.e. must have the same synchronized sampling rate).

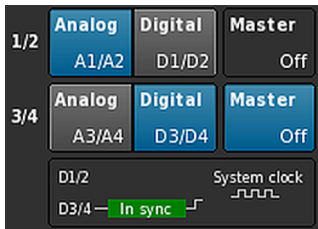

Mixed

Input connector pair 1/2 is set to «Analog», an analog 2-channel audio signal is accepted by inputs 1 and 2.

Input connector pair 3/4 is set to «Digital», a digital 2-channel audio signal is accepted by input 4.

A3 by input 3 is not available.

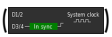
Locking to either 48 or 96 kHz is indicated below (). In this case, the sync source is input 4.

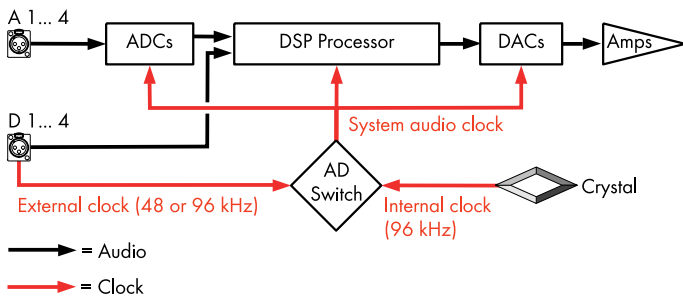

Clocking

To keep latency as short as possible, the system does not utilize non-clocked (asynchronous) Sample Rate Converters (SRC).

The clock of the digital audio system is derived from an internal crystal oscillator with a sampling rate of 96 kHz. Alternatively, the clock can be derived from a signal fed to the digital inputs. The sampling rate of this signal must also be 96 kHz. The derived clock is PLL filtered to avoid possible jitter.

It is also possible to use a signal with a sampling rate of 48 kHz as it is in even proportion to the required 96 kHz. In this case, the system detects the sampling rate and automatically doubles it using a synchronous sampling rate doubler to achieve the required 96 kHz. The required filtering is calculated using linear phase FIR filters.

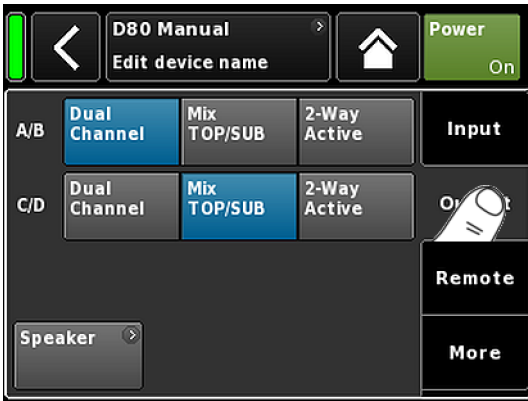

9.3. Output

Selecting the «Output» tab allows you to assign the appropriate Output mode to a pair of amplifier output channels (AMP A/B and/or AMP C/D).

The following Output modes can be assigned to a pair of amplifier output channels (AMP A/B and/or AMP C/D).

- Dual Channel
- Mix TOP/SUB
- 2-Way Active
- Mixed configurations

⇒ A change of the Output mode must be confirmed. This is done by selecting either the Back (⏪) or the Home (🏠) button.

⇒ The set Output mode will be activated and the corresponding channels will be muted.

Note: Changing the Output mode directly affects the available range of loudspeaker setups.

On the Home screen, the selected Output mode is displayed in the header area below the device name.

The channel strips below the Header section change depending on the chosen modes as shown below.



2 x Dual Channel



2 x Mix TOP/SUB



2 x 2-Way Active



Mixed configuration



On the bottom left of the Output screen, the «Speaker» navigation button provides direct access to the ⇒ Speaker setup screen.

9.3.1. Output mode

NOTICE!

Ensure that the connected loudspeaker type corresponds to the actual output configuration of the D80.

Dual Channel mode (A/B, C/D)

The Dual Channel mode is dedicated to d&b fullrange systems (passive systems) and actively driven d&b subwoofers. Both channels of each pair of amplifier channels can be configured for TOP or SUB cabinets independently.

In Dual Channel mode each pair of amplifier output channels (AMP A/B, AMP C/D) acts as a two channel amplifier (stereo amplifier). The amplifier channels are connected to their corresponding output connectors (AMP A to OUT A ...) while the audio input for each amplifier channel can be assigned via the input routing.

Each output connector is wired in parallel using the respective pins for TOP or SUB configurations.

Pin equivalents of NL4 and EP5 connectors in relation to the output mode are listed in the table below.

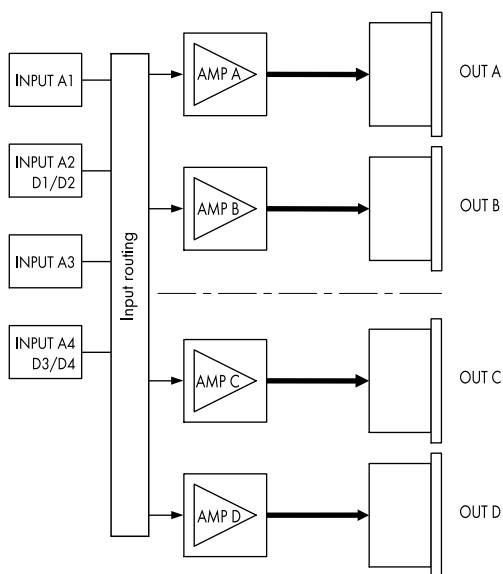

2 x Dual Channel mode

| | |
|------------|--|
| NL4 | SPEAKER OUTPUTS A (B, C, D): 1+/2+ = Amp A (B, C, D) pos. 1-/2- = Amp A (B, C, D) neg. |
| EP5 | SPEAKER OUTPUTS A (B, C, D): 1/3 = Amp A (B, C, D) pos. 2/4 = Amp A (B, C, D) neg. 5 = n.c. |



Mix TOP/SUB mode (A/B MIX, C/D MIX)

The Mix TOP/SUB mode allows d&b fullrange systems (passive systems) and actively driven d&b subwoofers to be linked together and connected to the amplifier using a single 4-wire cable.

TOP cabinets (setups) can be selected on channel A (C) and SUB cabinets (setups) on channel B (D).

In Mix TOP/SUB mode both amplifier channels of the corresponding pair (AMP A/B, AMP C/D) are connected to both output connectors (AMP A and AMP B to OUT A and OUT B ...) while the audio input for each amplifier channel can be assigned via the input routing.

Two output connectors (A/B, C/D) are wired in parallel using the respective pins for TOP and SUB configurations.

Pin equivalents of NL4 and EP5 connectors in relation to the output mode are listed in the table below.

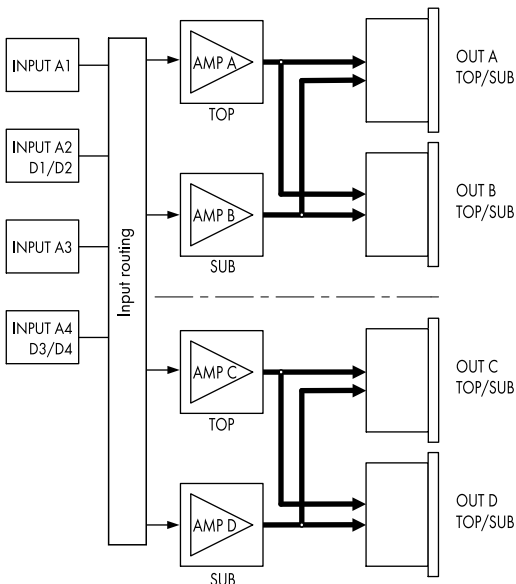

2 x Mix TOP/SUB mode

| | |
|------------|---|
| NL4 | <p>SPEAKER OUTPUTS A/B (C/D):</p> <p>1+ = Amp A (C) pos. (TOP)</p> <p>1- = Amp A (C) neg. (TOP)</p> <p>2+ = Amp B (D) pos. (SUB)</p> <p>2- = Amp B (D) neg. (SUB)</p> |
| EP5 | <p>SPEAKER OUTPUTS A/B (C/D):</p> <p>1 = Amp A (C) pos. (TOP)</p> <p>2 = Amp A (C) neg. (TOP)</p> <p>3 = Amp B (D) pos. (SUB)</p> <p>4 = Amp B (D) neg. (SUB)</p> <p>5 = n.c.</p> |

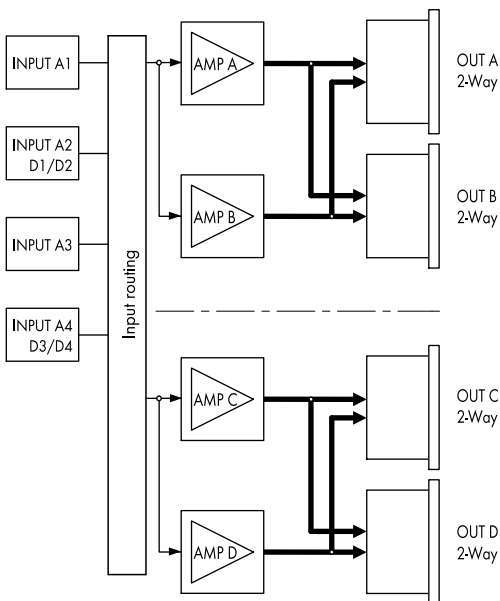

2 x 2-Way Active mode

2-Way Active mode (2-WAY)

The 2-Way Active mode is dedicated to d&b active systems.

In 2-Way Active mode both amplifier channels of the corresponding pair (AMP A/B, AMP C/D) are connected to both output connectors (AMP A and AMP B to OUT A and B ...). The audio input for each pair of amplifier channels can be assigned via the input routing.

All settings of channel A (C) and the corresponding input signal are internally linked to channel B (D).

Pin equivalents of NL4 and EP5 connectors in relation to the output mode are listed in the table below.

| | |
|------------|--|
| NL4 | SPEAKER OUTPUTS A/B (C/D): 1+ = Amp A (C) pos. (LF) 1- = Amp A (C) neg. (LF) 2+ = Amp B (D) pos. (MF/HF) 2- = Amp B (D) neg. (MF/HF) |
| EP5 | SPEAKER OUTPUTS A/B (C/D): 1 = Amp A (C) pos. (LF) 2 = Amp A (C) neg. (LF) 3 = Amp B (D) pos. (MF/HF) 4 = Amp B (D) neg. (MF/HF) 5 = n.c. |

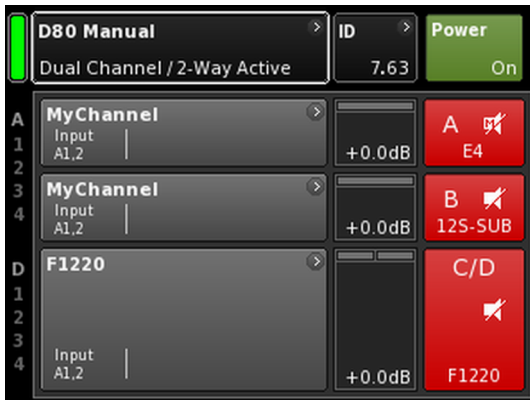

Mixed configurations

As the output mode is assigned to a pair of amplifier channels (AMP A/B, AMP C/D) mixed configurations such as ...:

- AMP A/B ⇒ Dual Channel, AMP C/D ⇒ 2-Way Active
- AMP A/B ⇒ Dual Channel, AMP C/D ⇒ Mix TOP/SUB
- AMP A/B ⇒ Mix TOP/SUB, AMP C/D ⇒ 2-Way Active

... as well as all other combinations are also possible.

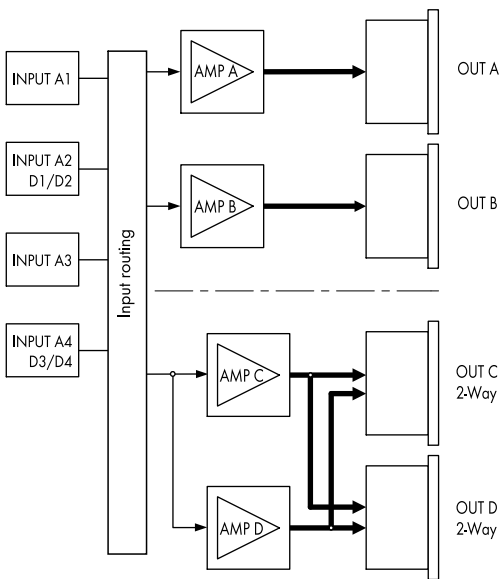

Mixed configuration example

AMP A/B ⇒ Dual Channel, AMP C/D ⇒ 2-Way Active

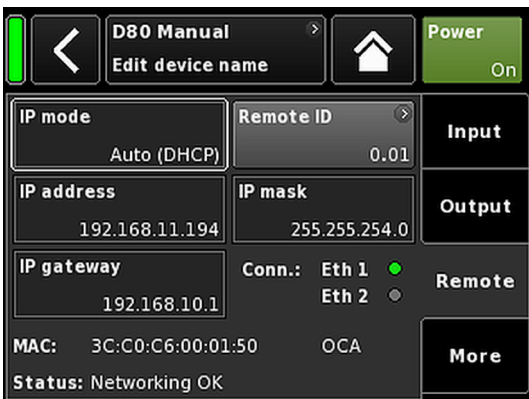
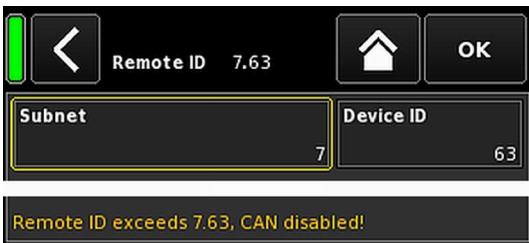
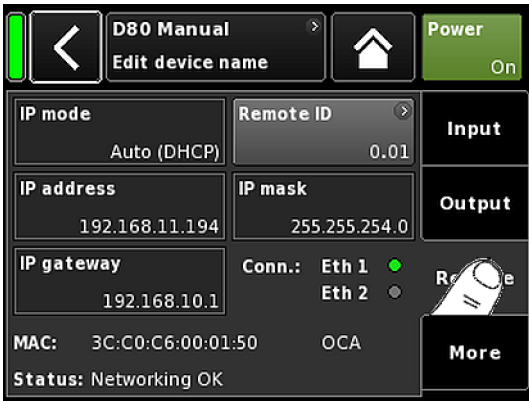

9.4. Remote

Selecting the «Remote» tab allows you to assign remote settings for both Ethernet and CAN remote control.

9.4.1. Remote ID

Selecting the «Remote ID» button allows the setting of the unique Remote identifier of the respective device in the format [nn].[nn].

Subnet

The first two digits represent the subnet.

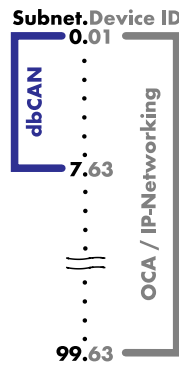

Within an **Ethernet network** up to 100 subnets can be defined (values 0 to 99).

Within a **CAN network** up to eight subnets can be defined (values 0 to 7).

Note: In case of a Subnet mismatch the following message is issued at the bottom of the screen:

Remote ID exceeds 7.63, CAN disabled!

Device ID

Using the two digit device ID for each subnet, you can define a total of 63 devices (values 1 to 63).

9.4.2. Ethernet settings

IP mode

Tapping the field allows the following settings:

Auto (DHCP)

When the device is connected to a network with a DHCP server present, a matching IP address will be assigned automatically.

Manual

Allows the manual assignment of IP settings.



**IP address
IP mask
IP gateway**

Selecting either field opens the numerical input mask and allows you to enter the relevant data.

Wrong entries can be corrected by tapping the Erase button (X) on the bottom right.

Tapping «OK» on the top right confirms the entry, closes the input mask and switches back to the Remote screen.

Tapping the Back button (←) on the top left cancels any entry and switches back to the Remote screen keeping the previous entry.

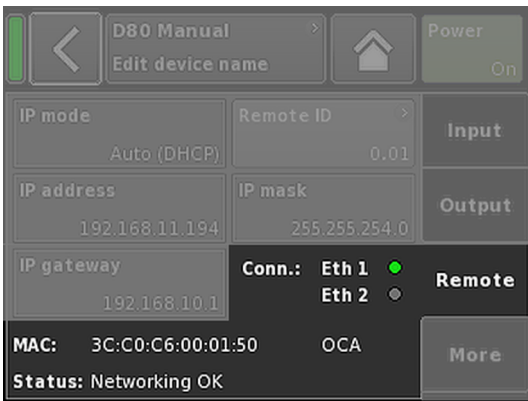

Conn.:

Shows which of the etherCON connectors is connected (busy).

MAC:

Displays the fixed MAC address of the device.

Status:

Provides status information on the network.



9.5. More

Selecting the «More» tab provides further subscreens such as:

- Preferences
- Info
- Levels
- Mains current limiter
- ...



9.5.1. Preferences

Selecting «Preferences» opens the corresponding subscreen with the «Display» tab being active.

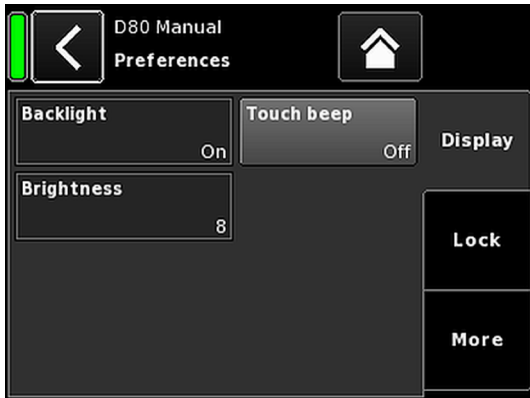

9.5.1.1. Display

The «Display» tab provides the following display options.

Backlight

Enables the following optional settings:

- Off** The display brightness is set to 1 (minimum brightness).
- On** The backlight is permanently on.
- Timeout 10s** The display is illuminated when the encoder is pressed or when the display is touched. The light switches off automatically 10 seconds after the last operation.

Note: This setting is recommended to increase the lifetime of the display.

Brightness

Enables adjustment of the display brightness in the range from 1 to 10. The default setting is 8.

Touch beep

Enables or disables the beep sound when using the touch screen.

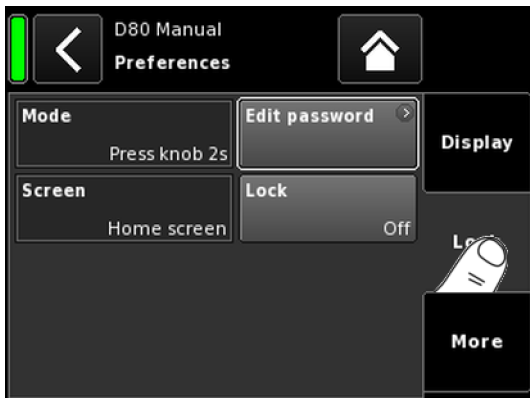

9.5.1.2. Lock

Selecting the «Lock» tab opens the corresponding subscreen which enables different protection settings.

Mode

Selecting «Mode» toggles between two options to protect the device against unintentional operation.

- Press knob 2s** Prevents accidental operation by locking the front panel controls.
- Password** Enables password protection to prevent operation by unauthorized persons.

Screen

Selecting «Screen» allows two different settings for the screen when the device is locked.

- Home screen** Switches to the Home screen.
- Levels screen** Switches to the Levels screen.

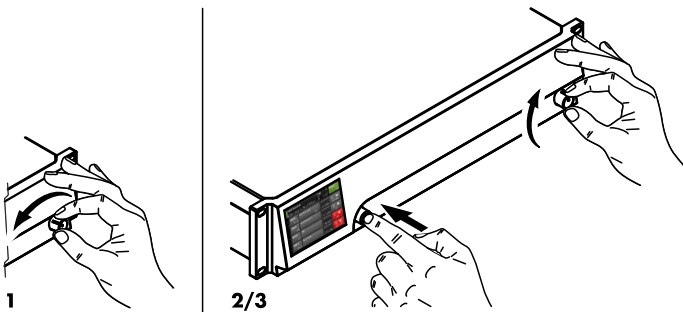
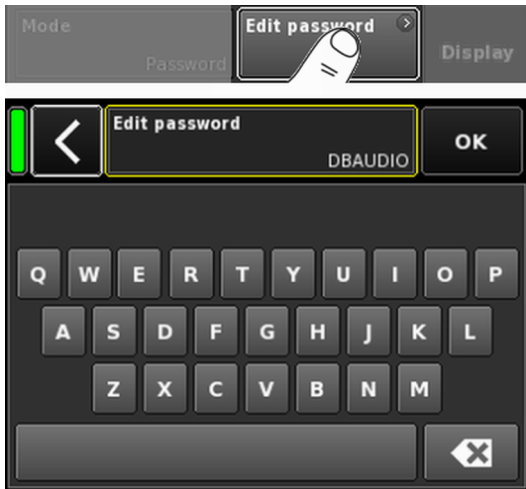

Edit password

Selecting the «Edit password» option opens an input mask which enables you to edit or assign a password (upper-case characters with a maximum length of 7 characters).

Wrong entries can be corrected by tapping the Erase button on the bottom right (✕).

Tapping «OK» on the top right confirms the entry, closes the input mask and switches back to the Lock screen.

Tapping the Back button (◀) on the top left exits the input mask and leaves the previous password unchanged.

Note: The factory default password is: DBAUDIO

Lock

Tapping the «Lock» button confirms any new settings and exits the subscreen. A corresponding message is displayed.

The device will be switched to the screen selected for Lock mode.

Unlocking the device

If you attempt to change the status of the device while it is in Lock mode, the following message will be issued: Press encoder for 2s to unlock. To unlock the device, proceed as follows:

- Press ...** Press and hold the encoder for a minimum of 2 seconds until the message disappears.
- Password**
1. Press and hold the encoder for a minimum of 2 seconds until the corresponding input mask is displayed.
 2. Enter the password as described above. An incorrectly entered password will revert the device to the screen displayed for Lock mode.

If the password is lost or forgotten, a locked device can be unlocked by performing a system reset.

1. Switch off the device.
2. Press and hold the encoder and repower the device.
⇒ Long confirmation beep.
3. Release the encoder and briefly press the encoder again within 2 sec.
⇒ Short confirmation beep.
The device will boot up and will switch to the Home screen. A corresponding message will be issued:

All device settings have been cleared

Note: All device preferences will be set to factory defaults except for the network (CAN/Ethernet) and fixed device settings.

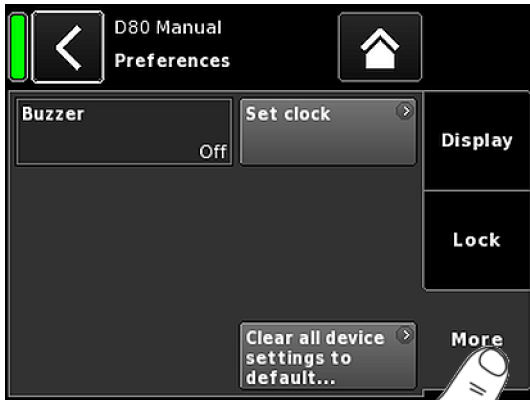

9.5.1.3. Preferences/More

Selecting the «More» tab opens the corresponding subscreen which provides the following options.

Buzzer

Enables the following settings:

- Off** The internal buzzer is switched off.
- On** The internal buzzer is switched on and serves as an acoustic signal in case of a device or channel error.
- Single** The internal buzzer generates an intermittent single tone.
- Melody** The internal buzzer generates a predefined sequence of tones.

Set clock

Enables setting the internal clock while the current UTC (Coordinated Universal Time) date and time are displayed at the bottom of the screen.

Within a Remote network, the device's clock is synchronized with the connected PC.

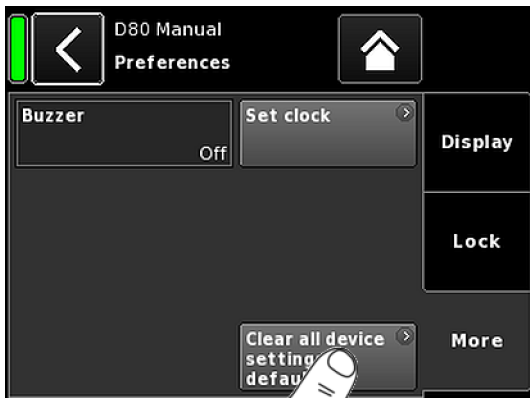
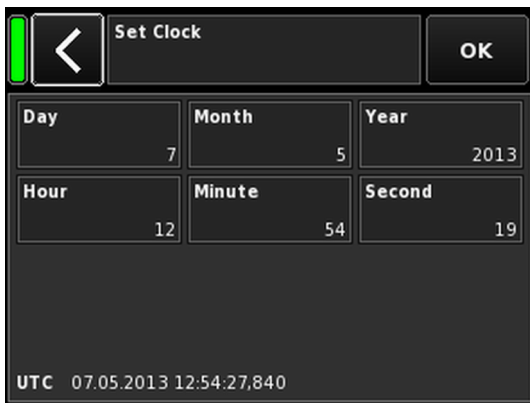

9.5.1.3.1. System reset

Selecting «Clear all device settings to default» resets all device settings to factory defaults except for the network (CAN/Ethernet) and fixed device settings.



To prevent accidental reset when you tap the «Clear...» / «Clear all device settings» button, a dialog will pop up prompting you to confirm the reset or cancel the sequence by tapping the Back button (⏪).

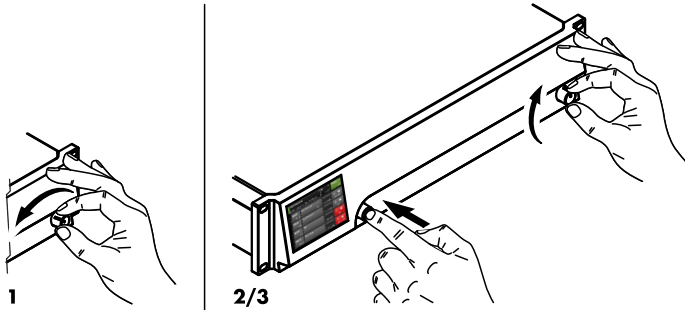

Alternative procedure

A system reset can also be triggered as follows:

Note: If you execute this procedure, no dialog will be prompted and the reset will start immediately.

1. Switch off the device.
2. Press and hold the encoder and repower the device.
⇒ Long confirmation beep.
3. Release the encoder and briefly press the encoder again within 2 sec.
⇒ Short confirmation beep.
The device will boot up and will switch to the Home screen. A corresponding message will be issued:

All device settings have been cleared



9.5.2. Info

Selecting «Info» provides basic information about the device.

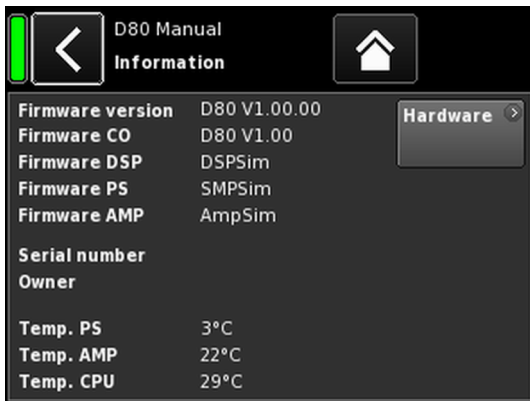

The information provided is mainly intended for service purposes.

Most of the information is static information, for example:

- Various firmware versions (Firmware Core/DSP/PS/AMP)
- Serial number
- Owner

In addition, there is dynamic information about the actual temperatures of... :

- Power supply (Temp. PS)
- The entire power amplifier (Temp. AMP)
- **C**entral**P**rocessing**U**nit (Temp. CPU)

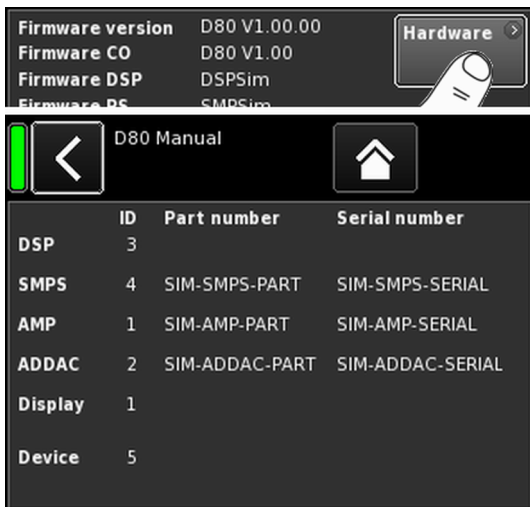

Tapping the «Hardware» button provides further hardware specific information.



| | | A | B | C | D |
|----------------|--|-------------|---------|---------|---------|
| Input | | E4 | E4 | E4 | E4 |
| Output | | +0.0dBu | +0.0dBu | +0.0dBu | +0.0dBu |
| Gainred./Headr | | 0V | 0V | 0V | 0V |
| Impedance | | -20dB | -20dB | -20dB | -20dB |
| Power | | 99.9Ω | 99.9Ω | 99.9Ω | 99.9Ω |
| Temperature | | 0W | 0W | 0W | 0W |
| ISP / OSP | | 19°C | 20°C | 21°C | 22°C |
| GR / OVL | | | | | |
| Mains / SMPS | | | | | |
| | | 221V / 55Hz | 243W | | 25°C |

9.5.3. Levels

Selecting «Levels» opens the corresponding subscreen.

The data area of the levels screen provides the following information (starting at the top left):

- 1st line** Mute status of each channel.
- 2nd line** Loudspeaker setups selected for the individual channels.
- Input** Current input signal levels of the individual channels.
- Output** Current output voltages of the individual amplifier channels.
- Gainred/Headr** Relationship between headroom (Headr) and gain reduction (Gainred) with peak hold for 1 sec.
 - Headr** -32 dB ⇒ 0 dB.
 - Gainred** 0 dB ⇒ +32 dB.
- Impedance** Current load impedance values for the individual amplifier channels.
- Power** Power currently delivered by the individual amplifier channels.
- Temperature** Current temperatures of the individual amplifier channels.
- ISP/OSP** Indicates whether the input signal (ISP) as well as the controller output signal (OSP) of the individual channel are present.
- GR/OVL** Indicates whether gain reduction (GR) of the respective channel is active or the respective channel is overloaded (OVL).
- Mains/SMPS** Displays the current mains voltage and frequency, the current mains power consumption in combination with a power limiter LED and the current temperature of the switched mode power supply (SMPS).

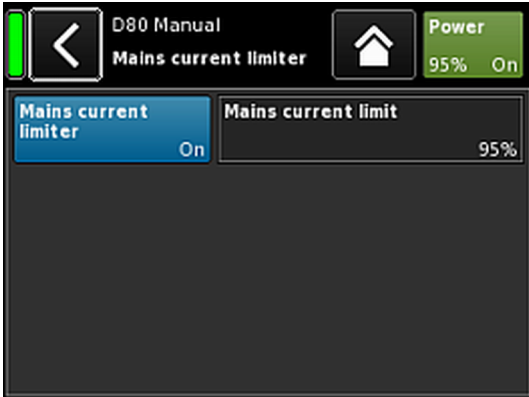

9.5.4. Mains current limiter (MCL)

Selecting «Mains current limiter» opens the corresponding subscreen.

The D80 features a power limiter which serves to limit the mains current draw whenever the mains current draw threatens to trigger the circuit breaker.

Limiting is done by reducing the sound levels evenly on all channels. This ensures that the tonal balance is kept.

The **Mains Current Limiter** function allows to set the maximum mains current draw of the device within the range of 95 to 50 % of the nominal limit. Nominal current limit depends on the mains voltage range: 16 A in high range, 30 A in low range

This may be useful when the onsite conditions require two devices to be operated per phase conductor or if the onsite circuit breaker is not sufficiently dimensioned.

On/Off Activates the additional limiter.

Mains current limit The maximum mains current draw is defined as a percentage value of the nominal current limit, as indicated above and can be set in the range from 95 % down to 50 % in steps of 5 %.

When the MCL is activated, the defined value is permanently displayed on the «Power» button on the Home screen.

Setting recommendations

| No. of devices | Circuit breaker | MCL setting |
|----------------|------------------|-------------|
| 1 x D80 | 13 A @ 230/240 V | 80 % |
| 2 x D80 | 16 A @ 230/240 V | 50 % |

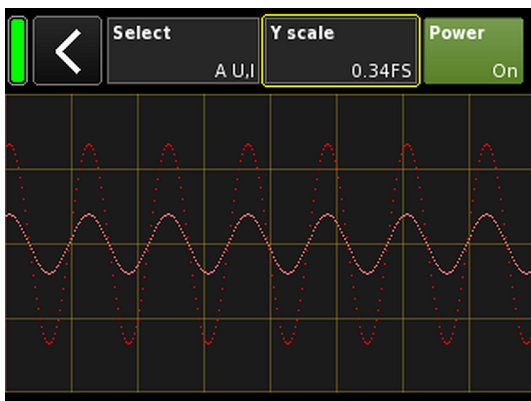
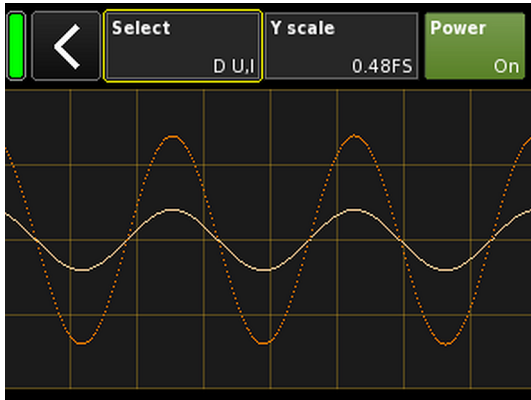

9.5.5. Scope

The «Scope» function allows basic signal monitoring of the amplifier's output voltage (full color) and output current (light color).

Select

- A U, I** Output voltage and current of channel A.
- B U, I** Output voltage and current of channel B.
- C U, I** Output voltage and current of channel C.
- D U, I** Output voltage and current of channel D.
- All U** Output voltage of all channels.
- All I** Output current of all channels.
- All U, I** Output voltage and current of all channels.

Y scale

Scale of the measuring values in FS (Full Scale). 1.0 FS represents the maximum output voltage or output current.

Application examples

The scope function is a useful tool for ...:

- determining the signal quality.
- determining a phase shift between the channels.
- getting a rough impression of the crest factor.
- checking the output channels (e.g. no output current displayed \Rightarrow the connector cable may be interrupted or no loudspeaker is connected).
- checking the power amplifier (e.g. no output voltage displayed).

10. Channel setup

Channel setup access chart

Hierarchy level

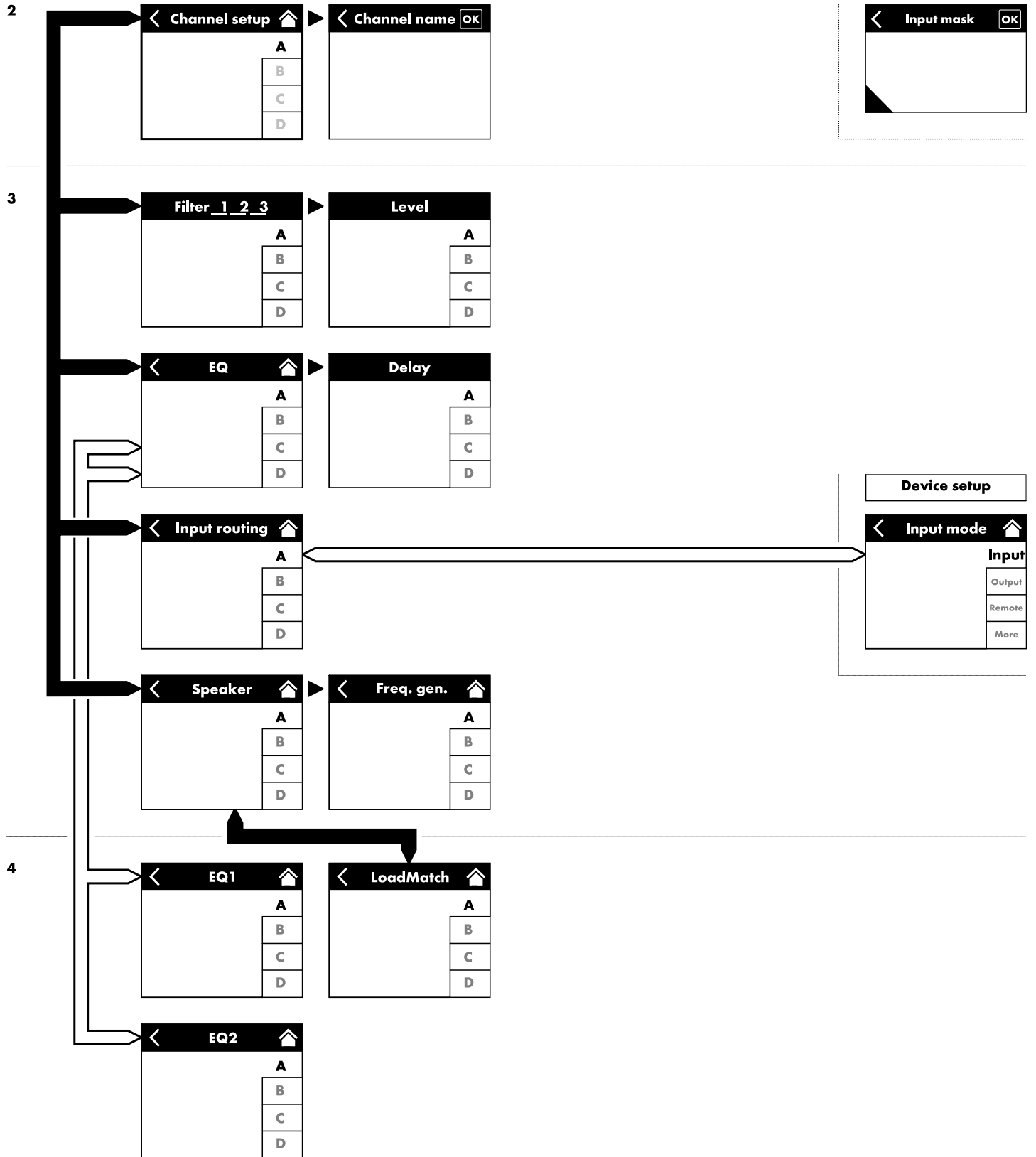



Selecting a particular channel from the Home screen opens the corresponding Channel setup screen with the respective Channel tab being active.



The Channel setup screen follows the same layout structure as described above and is split into the Header and the Data sections.

Using the tabbed structure of the Channel setup screen provides direct access to the desired function element of each channel.

In addition, the Channel mute button of the selected channel as well as the "OSP", "GR" and "OVL" indicators for each channel are available. This allows you to maintain the integrity of the gain structure within the unit while setting up the user definable EQ as well as keeping an eye on the Input routing.



10.1. Channel name

Selecting the centered Information field button («Edit channel name») in the header of the Channel setup screen enables you to enter or edit the Channel name (maximum length 15 characters).



The input mask which appears allows either lower-case or upper-case characters by toggling the corresponding button («abc») on the bottom left.

Wrong entries can be corrected by tapping the Erase button (X) on the bottom right.

Tapping «OK» on the top right confirms the entry, closes the input mask and switches back to the channel setup screen.

Tapping the Back button (←) on the top left cancels any entry and switches back to the Channel setup screen keeping the previous entry.



10.2. Configuration switches - Filter_1, _2, _3

The type of filters available depends on the selected loudspeaker setup.

Depending on the type of filters, these are available as function buttons or input fields.

The name of the filter is displayed on the top left of the button or field while the On/Off status or the value is displayed on the bottom right. In addition, the On/Off status is also indicated by colors.

| Filter_1 | Filter_2 | Filter_3 |
|---|---|--|
| Configuration of crossover frequencies for TOP/SUB, e.g. CUT, 100 Hz, Infra ... Note: CUT in LINEAR setup: - Butterworth 2nd order (12 dB/oct.) - Corner frequency: 110 Hz - Amplifier gain @ 0 dB: 31 dB. | Compensation of listening distance, e.g. HFA, HFC. HFC: Off, +1 (HFC1), +2 (HFC2). CSA: Cardioid Subwoofer Array. | CPL ⇒ Array-EQ (compensation of coupling effects) CPL range: -9 dB ... 0 dB (Off): Cut (Lo shelf) 0 dB (Off) ... +5 dB: Boost (65 Hz, Bell) |



On the Home screen, the On/Off status or the set values of the Configuration switches are indicated by the entry on the Channel view button of the corresponding channel strip, as shown in the graphic opposite.

Note: A detailed description of the filters available for each loudspeaker is given in the relevant loudspeaker manuals.

A detailed description of the CSA function (Cardioid Subwoofer Array) is given in the technical information TI 330 which can be downloaded from the d&b website at www.dbaudio.com.



10.3. Level

Input sensitivity of the respective power amplifier channel or set of channels (depending on the output mode), adjustable within a range of -57.5 dB to +6 dB in steps of 0.5 dB.



10.4. EQ - Equalizer

Selecting «EQ» opens the equalizer subscreen of the respective channel.

The graphic opposite shows the location of the equalizer (User EQ) within the signal chain.

The equalizer provides two independent and user definable 16-band equalizers (2 x 16 minimum phase biquad IIR filters, full parametric) and is split into two layers:

⇒ EQ overview,

⇒ EQ layer/curve.

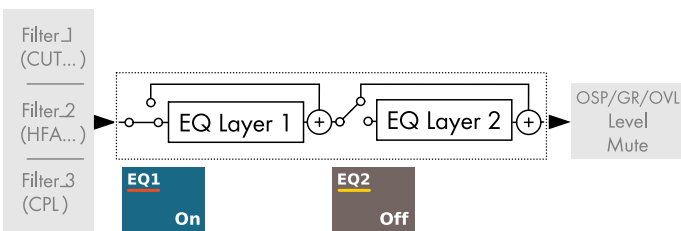

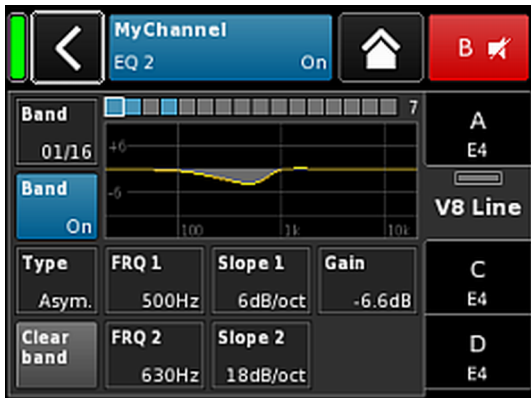
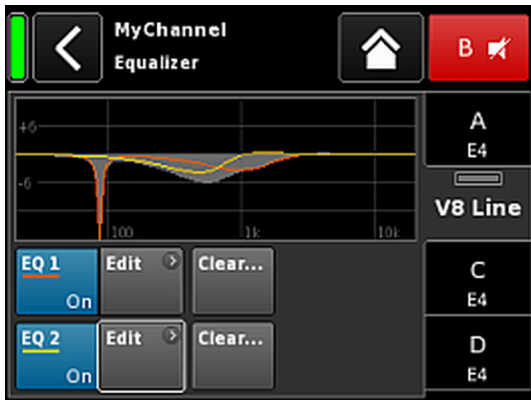

EQ overview

The upper part of the overview provides the overall frequency response of all filters while «EQ 1» is displayed in red and «EQ 2» in yellow.

Active filters are displayed by continuous lines and the curves are filled with grey color while inactive filters are displayed by dashed lines.

The bottom part of the overview provides the following functions:

EQ [n] On/Off Master On/Off switch for the respective EQ.

Edit Opens the corresponding subscreen (EQ layer/curve) for editing.

Clear... Resets all filter settings of the corresponding EQ.
To prevent accidental reset when you tap the «Clear...» / «Clear all device settings» button, a dialog will pop up prompting you to confirm the reset or cancel the sequence by tapping the Back button (⏪).

On the Home screen, the On/Off status of the equalizer is indicated by the entry «EQ» on the Channel view button of the corresponding channel strip, as shown in the graphic opposite.

EQ layer/curve

Apart from the overall frequency response, the following functions and status indicators are provided:

Header section EQ [n] - On/Off On/Off status of the corresponding EQ.
This field also acts as On/Off switch for the respective EQ.

Data section
Line by line from left to right:

Band selector Allows the selection of a filter band from the Filter band bar using the encoder.



Filter band bar 

Displays all filter bands that are in use while the number of remaining filter bands is indicated next to the bar on the right.

Band On/Off Switches the selected filter band on or off.

Type

Each filter band reserves 1...4 filters depending on the type.

The following table lists the available types, their corresponding parameters and the number of filter bands required for the selected type.

| Type | Param. 1 | Param. 2 | Param. 3 | Param. 4 | Param. 5 | No. of filters |
|-----------------------------|----------|--------------------------------------|----------|----------|----------|----------------|
| PEQ (Parametric EQ) | FRQ | Q (and corresponding bandwidth - BW) | Gain | | | 1 |
| Notch | FRQ | Q (and corresponding bandwidth - BW) | | | | 1 |
| HiShlv | FRQ | Slope | Gain | | | 2 |
| LoShlv | FRQ | Slope | Gain | | | 2 |
| Asym (Asymmetric filter) | FRQ 1 | Slope 1 | Gain | FRQ 2 | Slope 2 | 4 |

Parameter ranges and resolutions:**Type**

The available filter types.

FRQ

Filter frequency (center/corner frequency), adjustable from 20 Hz to 20 kHz.

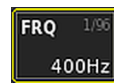

On the top right of the «Frequency/FRQ» input field, the increment is displayed as an octave value. When you tap the field for the first time, the frequency increment is set to 1/6 octave. When you tap the field again, you can toggle between 1/6 and 1/96 octave increments.

To confirm the set frequency, press the encoder.

**Q
BW**

Q of the filter, adjustable from 0.5 ... 25 in 10 % steps.
In addition, the resulting bandwidth (BW) is displayed as a value (2.0 ... 0.04 octaves) in a non-editable Information field below the Q Input field.

Slope

Slope can be set to 6, 12, 18 or 24 dB/octave.

Gain

Gain, adjustable from -18 dB to +12 dB in 0.2 dB steps.

Clear band

Resets all settings of the selected filter band right away.

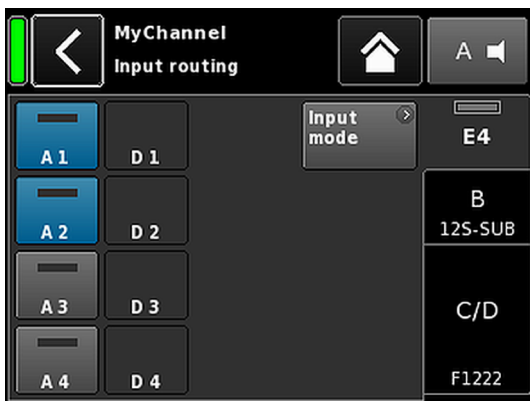

10.5. DLY - Delay

An independent signal delay is available for each channel to allow delay settings of up to 10000 ms/10 sec (3440 m/11286 ft).

DLY On/Off

Switches the delay on or off without affecting the entered delay values.

Set to "On" the set value will be applied right away.

Value

The delay time is adjustable from 0.3 to 10000 ms in steps of 0.1 ms or a corresponding value depending on the units selected.

Unit

Enables selection of the delay units, either milliseconds [ms], meters [m], feet [ft] or seconds [s].

A change in the units will be applied to all channels.

On the Home screen, the "On" status of the delay is indicated by the set value and unit on the Channel view button of the corresponding channel strip, as shown in the graphic opposite.

10.6. Input routing

Selecting «Input routing» opens the corresponding subscreen.

The input sources can be selected individually per amplifier channel or pair of amplifier channels (depending on the output mode setting):

1 to 4 input sources can be selected per amplifier channel. The first input source can be selected freely from all available input channels (defined by input mode). All subsequent input sources must be set to the same type as the first one:

Example

- Analog + Analog (e.g. A1 + A3; not: A1 + D3).
- Digital + Digital (e.g. D1 + D3; not: D1 + A3).

Note: Attenuation of 6 dB with two or more sources selected. The input routing is stored for every input mode setting. When the input mode setting is changed from analog to digital mode and back again, the input routing of the analog mode is recovered again.

The Input routing screen also provides direct access to the ⇒ Input mode screen.

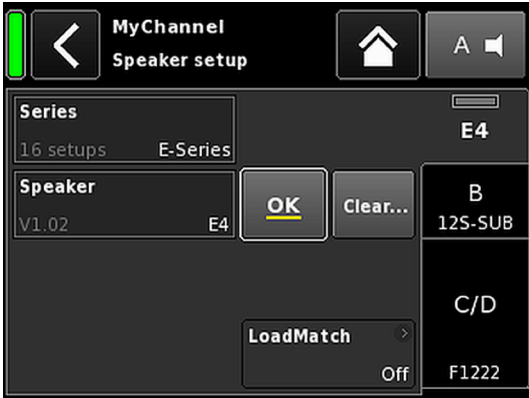

10.7. Speaker

Selecting «Speaker» opens the Speaker setup subscreen which enables the selection of loudspeaker setups for the applicable d&b loudspeakers (depending on the selected output mode).

The setups available are arranged in two blocks, «Series» and «Speaker».

Back (⏪)

The Back button provides two options:

1. The selection has not been confirmed by tapping «OK» ⇒ Cancel: Exits the subscreen and the previous configuration remains active.
2. The selection has been confirmed by tapping «OK»: Exits the subscreen.

Series

The bottom left of the «Series» Input field displays the number of setups available while the bottom right displays the actual name of the Series.

The list is in alphabetical order, the starting point, however, is the Series currently loaded.

Selecting «(All)» provides direct access to all setups available and the LINEAR setup.

Speaker

The bottom left of the «Speaker» input field displays the version of the selected loudspeaker setup while the bottom right displays the actual setup name.

The loudspeaker list is either in numerical or alphabetical order depending on the selected series.

When «(All)» is selected in the «Series» field, the list starts with the numeric setup names followed by the remaining setup names in alphabetical order. The starting point, however, is the setup currently loaded.

OK

Selecting «OK» adjacent to the «Speaker» selection field confirms the configuration and the selected setup will be activated.

Clear...

To prevent accidental reset when you tap the «Clear...» / «Clear all device settings» button, a dialog will pop up prompting you to confirm the reset or cancel the sequence by tapping the Back button (⏪).

Selecting the «Clear...» button clears/resets the following loudspeaker related settings of the respective channel.

- Configuration switches (Filter_1, Filter_2, Filter_3) are reset.
- Level is set to 0 dB.
- Delay settings are reset (the selected unit will be kept).
- All EQ settings are reset.

LoadMatch For applicable loudspeakers, the LoadMatch button becomes functional. It indicates the On/Off status of the function and provides direct access to the ⇒ LoadMatch subscreen

Note: LoadMatch does not apply to all loudspeakers. When the function is not applicable, this button is not functional.

10.7.1. LINEAR setup

In addition to the loudspeaker specific setups, a LINEAR setup is also available allowing the D80 to be used as a linear power amplifier.

Note: CUT in LINEAR setup:

- Butterworth 2nd order (12 dB/oct.)
- Corner frequency: 110 Hz
- Amplifier gain @ 0 dB: 31 dB.



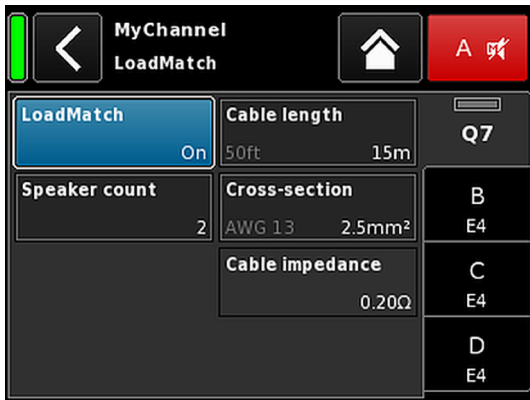

10.7.2. LoadMatch

Selecting «LoadMatch» on the Speaker setup screen opens the LoadMatch subscreen.

⇒ To activate LoadMatch, tap the On/Off button on the left next to the «Cable length» input field.

For applicable loudspeakers, the d&b LoadMatch function enables the D80 amplifier to electrically compensate for the properties of the loudspeaker cable used. This function, which covers a bandwidth of up to 20 kHz preserves the tonal balance when cable lengths of up to 70 m (230 ft) are used.

LoadMatch does not require an additional sense wire and is therefore applicable with any connector type used.

To provide optimum compensation, LoadMatch requires the entry of the following three parameters:

Cable length Length of the cable in meters in steps of 5 m.
 ⇒ The corresponding length in "ft" is displayed on the bottom left of the input field.

Speaker count Number of cabinets connected.

Cross-section Cross section in square millimeters (mm²) in steps of 0.5 mm² up to a maximum of 10.0 mm².
 ⇒ The corresponding "AWG" value is displayed on the bottom left of the input field.
 ⇒ The resulting cable impedance is shown as an ohmic value in the «Cable impedance» Information field below.

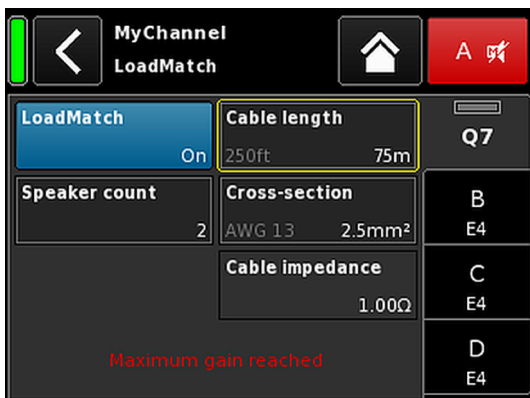

Maximum gain reached

Depending on the LoadMatch settings the message «Maximum gain reached» indicates the limit up to which the LoadMatch function works.

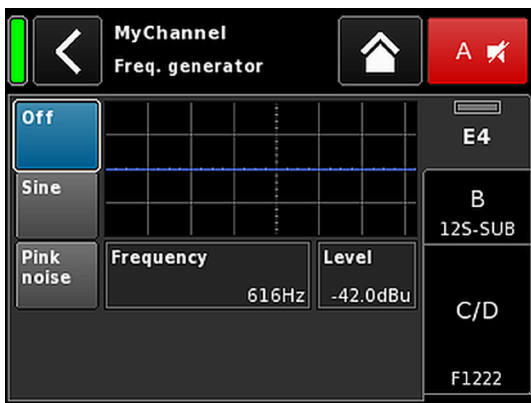
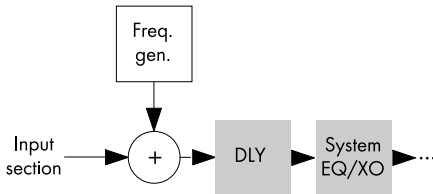

10.8. Frequency generator - Freq. gen.

Selecting «Freq. gen.» opens the corresponding subscreen.

Each amplifier channel is equipped with an independent signal generator offering sine wave or pink noise signals.

The generator provides pure-spectral sine wave signals with high frequency accuracy and free of harmonics.

The generator can be used to check the connected loudspeakers or to identify room resonances, for example.

The generator is inserted in the signal path after the input section and before the actual signal processing. The test tone will sum up with any input signal present.

Note: As a precautionary measure, the frequency generator is always set to Off after the device is powered on.

Off The frequency generator is switched off (Bypass).

Sine/ Pink noise Selecting either «Sine» or «Pink noise» the frequency generator will be switched on, providing the desired signal.

Frequency The frequency is adjustable from 10 Hz to 20 kHz.



On the top right of the «Frequency/FRQ» input field, the increment is displayed as an octave value. When you tap the field for the first time, the frequency increment is set to 1/6 octave. When you tap the field again, you can toggle between 1/6 and 1/96 octave increments.

To confirm the set frequency, press the encoder.

Level The level in dBu is adjustable from -57.5 dB to +6 dB in 0.5 dB steps.

The level value corresponds to the level at the controller signal input. The actual output voltage depends on the channel input gain, the frequency dependent gain of the selected loudspeaker setup and the EQ settings, if applicable.

On the Home screen, the On/Off status of the generator is indicated by the entry «FG» on the Channel view button of the corresponding channel strip, as shown in the graphic opposite.

11. Web Remote interface

In addition, a Web Remote interface is integrated which provides direct access to the user interface of a single amplifier using a standard web browser.

Note: The user interface of the amplifier can only be accessed after connecting the amplifier to a computer via Ethernet. It is possible to connect the computer and the amplifier directly, however, this requires to manually set static IP addresses.

For this reason, the use of a router with DHCP server is recommended for setting up the network connection. If the router also provides a wireless access point, the amplifier may also be controlled using mobile devices.

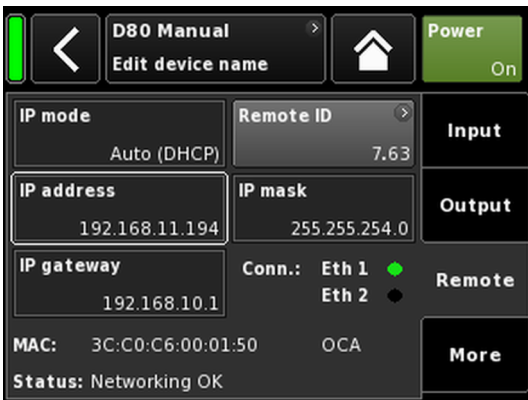

To enable remote control via the Web Remote interface, proceed as follows:

1. Simply connect the etherCON connector of the amplifier to the router. Multiple amplifiers may be daisy chained to connect to one single port of the router.
⇒ After a while, the «Remote» tab of the amplifier screen will display the IP address the DHCP server has assigned to the device.
2. Type this address into the address field of the browser or the mobile device that is connected to the network.



Example of IP address entry

⇒ For multiple amplifiers, open one browser tab for each amplifier connected.

Web Remote interface page

The Web Remote interface page is split into three tabs: the «Web Remote», the «Event log» and the «Commands» tabs.

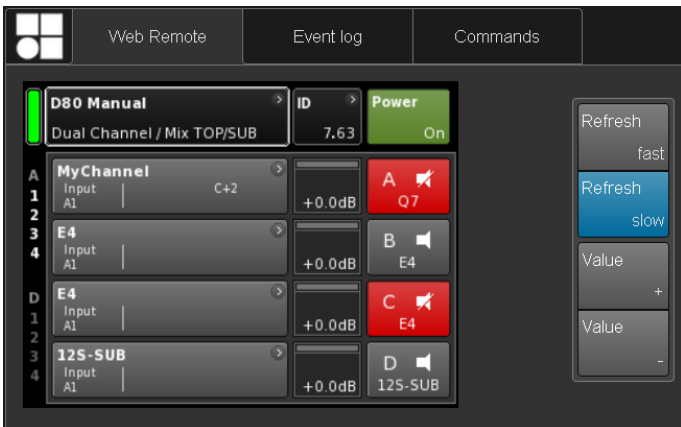

Web Remote

The «Web Remote» tab shows the actual screen of the connected amplifier.

All screens and screen items can be accessed in the same manner as on the touch screen by simply clicking the relevant screen item.

The refresh rate can be set to fast or slow.

Refresh fast Refresh rate is 1 second.

Refresh slow Default setting: Refresh rate is 30 seconds. This setting is recommended for larger amplifier networks in order to minimize network traffic. However, when you click any screen item, the screen will be refreshed within 1 second.

To change the value of an input field such as CPL, Level, Delay time, EQ settings or Speaker setup, proceed as follows:

1. Click the appropriate field and change the value using the «Value +»/«Value -» buttons.
2. To confirm the set value, click the relevant field again or click the respective «OK» button.
3. To change/enter a device or channel name as well as IP settings, click the relevant screen item.
 - ⇒ An input mask will be displayed which allows you to enter the desired data by clicking the respective characters and/or numbers.
4. Confirm your entry by clicking the corresponding «OK» button.

Event log

The «Event log» section stores a maximum of 10000 records. The last 20 records stored are displayed.

Once the maximum number of records is reached, the system starts deleting the first ones ⇒ Ring buffer.

| Record no. | UTC Date + Time | Type | Text no. | Text |
|------------|-------------------------|--------------------|----------|---|
| 124 | 26.10.2014 06:16:41,016 | Warning appeared | 11 | Warning: Amp is in simulation mode |
| 125 | 26.10.2014 06:16:43,068 | Info | 17 | Startup count 22, power-on time 25h 43min |
| 126 | 26.10.2014 07:20:00,016 | Warning appeared | 49 | Task 5 restarted |
| 127 | 26.10.2014 10:40:00,012 | Warning appeared | 49 | Task 5 restarted |
| 128 | 27.10.2014 03:38:02,090 | Info | 1 | ***** Startup D80 V1.02.02 ***** |
| 129 | 27.10.2014 03:38:03,760 | Error appeared | 47 | ADDAC board info read error -32 |
| 130 | 27.10.2014 03:38:04,004 | Warning appeared | 10 | Warning: SMPS is in simulation mode |
| 131 | 27.10.2014 03:38:04,004 | Warning appeared | 11 | Warning: Amp is in simulation mode |
| 132 | 27.10.2014 03:38:06,124 | Info | 17 | Startup count 23, power-on time 33h 11min |
| 133 | 27.10.2014 05:33:20,012 | Warning appeared | 49 | Task 5 restarted |
| 134 | 27.10.2014 10:35:29,748 | Error #58 appeared | 408 | Channel 'A': DSP communication error |
| 135 | 27.10.2014 10:35:29,748 | Error #58 appeared | 408 | Channel 'B': DSP communication error |
| 136 | 27.10.2014 10:35:54,220 | Error #58 cleared | -408 | Channel 'A': DSP communication error |
| 137 | 27.10.2014 10:35:54,220 | Error #58 cleared | -408 | Channel 'B': DSP communication error |
| 138 | 27.10.2014 11:40:00,028 | Warning appeared | 49 | Task 5 restarted |
| 139 | 29.10.2014 04:38:12,148 | Info | 1 | ***** Startup D80 V1.02.02 ***** |
| 140 | 29.10.2014 04:38:13,848 | Error appeared | 47 | ADDAC board info read error -32 |
| 141 | 29.10.2014 04:38:14,108 | Warning appeared | 10 | Warning: SMPS is in simulation mode |
| 142 | 29.10.2014 04:38:14,112 | Warning appeared | 11 | Warning: Amp is in simulation mode |
| 143 | 29.10.2014 04:38:16,312 | Info | 17 | Startup count 24, power-on time 42h 56min |

Capacity: 10000 records, last record no.: 143
Current time on device: 29.10.2014 08:35:11 UTC

Web Remote Event log Commands

Password: Login

Web Remote Event log Commands

d&b audiotechnik D80

- Licenses and Copyright

Commands

This functionality is intended for service purposes only

Licenses and Copyright

Selecting the d&b logo at the top left opens the «Licenses and Copyright» information page.

12. Error messages

The following table lists possible error messages appearing on the display.

| Id | Error text | Eventlog text | Description | Location | Possible reasons |
|-----------|------------------------|---|---|------------------------|--|
| 10 | System error 8 | System error 8 (%02Xh, %d) | Unexpected CPU reset | DSP | Software or hardware error |
| 11 | System error 128 | System error 128 (%02Xh, %d) | Internal I ² C communication fault | DSP | Any I ² C device defect |
| 15 | Unknown device type | Unknown device type | Unknown device type | | |
| 16 | Invalid device ident | Invalid device ident %d | Invalid hardware configuration | ADDAC, Amp., SMPS | Missing or wrong module identification |
| 17 | Invalid CPLD version | Invalid CPLD version %d (minimum required %d) | Invalid CPLD identification | DSP | Missing or wrong CPLD identification |
| 18 | Invalid ADDAC ident | Invalid ADDAC board ident %d | Invalid ADDAC identification | ADDAC | Missing or wrong ADDAC identification |
| 19 | Invalid display ident | Invalid display board ident %d | Invalid DISPLAY identification | DISPLAY | Missing or wrong DISPLAY identification |
| 20 | Program error %u | Program error %d, %d, %d, %d | Program error | DSP | Various |
| 21 | Invalid DSP Data | Invalid DSP database (Position %d, Error %d) | Invalid DSP data | DSP | Software error |
| 25 | Program error %u | Program error %d: AWL error %d in AWL %d, line %d | Program error | DSP | Various |
| 28 | SMPS comm. error | SMPS communication error (status %04X) | SMPS communication fault | DSP, SMPS | DSP or SMPS defect, cable defect |
| 29 | SMPS firmware mismatch | SMPS firmware V%d. %02d.%02d not suitable for hardware ident %d | Invalid SMPS configuration | SMPS | SMPS firmware does not match module identification |
| 30 | SMPS temp err %d °C | SMPS temperature error %+3d °C (power %uw) | Temp-Off | | |
| 31 | SMPS overtemp %d °C | SMPS overtemperature %+3d °C (power %uw) | SMPS overtemperature | SMPS | Poor cooling |
| 32 | Mains overvoltage %dV | Mains overvoltage (avg %3dV, peak %3dV, status %04X, err %04X) | Mains overvoltage | (External: Mains) | Mains voltage is/was too high |
| 34 | Mains undervoltage %dV | Mains undervoltage (avg %3dV, peak %3dV, status %04X, err %04X) | Mains undervoltage | (External: Mains) | Mains voltage is/was too low |
| 35 | SMPS error POK | SMPS error POK: timeout while waiting for power-ok signal %ums (PSF %4.1uV, avg %5.1dV) | SMPS startup timeout | SMPS | SMPS defect |
| 36 | SMPS restart error | SMPS error: too many restarts (restart count %d) | SMPS restart fault | SMPS | SMPS defect |
| 38 | SMPS overcurrent %dA | SMPS Error: overcurrent (I-peak %3dA, avg %3dV, status %04X, err %04X) | Mains overcurrent | (External: Power draw) | Heavy output load |

| Id | Error text | Eventlog text | Description | Location | Possible reasons |
|-----------|--------------------------|---|--|------------------------------------|--|
| 39 | SMPS error IAC %dA | SMPS error IAC (I-peak %3dA, avg %3dV, status %04X, err %04X) | SMPS fault | SMPS | SMPS defect |
| 40 | SMPS temp. sensor fault | SMPS temperature sensor fault (T1 % +3d;T2 % +3d;T6 % +3d;T7 % +3d) | SMPS temperature sensor fault | SMPS | SMPS defect |
| 41 | SMPS DC undervoltage | SMPS DC undervoltage error (I-peak %3dA, avg %3dV, status %04X, err %04X) | Amplifier rail voltage not reached | SMPS, Amp. | Amp. overcurrent or SMPS defect |
| 42 | SMPS DC overvoltage | SMPS DC overvoltage error (I-peak %3dA, avg %3dV, status %04X, err %04X) | Amplifier rail voltage exceeded | SMPS | SMPS defect |
| 43 | SMPS supply error | SMPS supply error 15V (I-peak %3dA, avg %3dV, status %04X, err %04X) | SMPS 15 V supply fault | SMPS | SMPS defect |
| 44 | SMPS error off %dV | SMPS error: power supply went unexpectedly off (avg %3dV, peak %3dV, status %04X, err %04X) | SMPS went unexpectedly off | SMPS, External: Mains | Mains voltage is/was too low or SMPS defect |
| 45 | Amp. comm. error | Amp. communication error (status %04X) | Amp. communication fault | DSP, Amp. | DSP or Amp. defect |
| 46 | Amp. firmware is too old | Amp. firmware version %4.2d is too old, required is %4.2d | Amp. firmware version is older than required | Amp. | Amp. software error |
| 50 | Invalid device para | Channel '%c': invalid device parameters (device ident %d) | Invalid device parameters | DSP | Software error or wrong device type detected |
| 51 | Invalid DSP prog %u | Channel '%c' : invalid DSP program %d | DSP program invalid | DSP | Software error |
| 52 | DSP boot error | Channel '%c': DSP boot error (DSP program %d) | DSP boot error | DSP | DSP or software error |
| 58 | DSP comm. error | Channel '%c': DSP communication error | DSP communication fault | DSP | DSP defect or software error |
| 59 | Invalid setup data | Channel '%c': invalid speaker setup (speaker id %d, no. %d, err %d) | DSP invalid setup data | DSP | Software error |
| 61 | Invalid FIR filter %d | Channel '%c': invalid FIR filter %d (file version %d) | DSP invalid FIR data | (External: FIR data file invalid) | Software error |
| 79 | Amp. firmware mismatch | Amp. firmware V%d. %02d.%02d not suitable for hardware ident %d | Amp. has wrong firmware | Amp. | Amp. firmware does not support the Amp. hardware |
| 80 | Amp. ground fault | Amp. ground fault (status %04X, err %04X, %5.1dV, %5.1dV) | Ground fault | External: Wrong speaker connection | Error in speaker wiring, ground connection |

| Id | Error text | Eventlog text | Description | Location | Possible reasons |
|-----------|-----------------------------|--|--|---------------------|---------------------------------------|
| 81 | Amp. supply fault | Amp. supply fault 5 V (status %04X, err %04X, %4.1dV) | Amp. 5 V supply voltage fault | Amp. | Amp. defect |
| 84 | Amp. supply fault | Amp. supply fault 12 V (status %04X, err %04X, %4.1dV) | Amp. 12 V supply voltage fault | Amp. | Amp. defect |
| 85 | Amp. supply fault | Amp. supply fault GND (status %04X, err %04X, %4.1dV) | Amp. gnd voltage fault | Amp. | Amp. defect |
| 86 | Amp. supply fault | Amp. supply fault 230V (status %04X, err %04X, %4.1dV) | Amplifier rail voltage fault | Amp., SMPS | Amp. overcurrent, Amp. or SMPS defect |
| 88 | Amp. I ² C fault | Amp. I ² C fault (status %04X, err %04X) | Amp. internal communication fault | Amp. | Amp. defect |
| 90 | Amp. DC fault | Channel '%c': Amp. DC fault | Amp. detected DC voltage output | Amp. | Amp. defect |
| 91 | Amp. overcurrent | Channel '%c': Amp. output overcurrent (power %uw) | Overcurrent on output | (External: Cabling) | Short circuit |
| 92 | Amp. temperature error | Channel '%c': Amp. temperature error %d°C (filter temp. %d°C, power %uw) | Amp. temperature error | DSP | Software fault on DSP |
| 93 | Filter overtemp %d°C | Channel '%c': Amp. filter over temperature %d°C (power %uw) | Amp. over temperature of output filters | Amp. | Poor cooling |
| 94 | Amp. clock fault | Channel '%c': Amp. clock fault (%3dkHz, power %uw) | Amp. clock fault | Amp. | Amp. defect |
| 95 | Amp. overtemp %d°C | Channel '%c': Amp. overtemperature %d°C (power %uw) | Amp. over temperature | Amp. | Poor cooling |
| 96 | Amp. temp sensor fault | Amp. temperature sensor fault (A %d°C, B %d°C, C %d°C, D %d°C) | Amp. temperature sensor fault | Amp. | Amp. defect |
| 99 | Amp. temp warn %d°C | Channel '%c': Amp. temperature warning %d°C (power %uw) | Amp. temperature warning | Amp. | Poor cooling |
| 100 | SMPS temp warn %d°C | SMPS temperature warning %d°C (power %uw) | SMPS temperature warning | SMPS | Poor cooling |
| 101 | Filter temp wrn %d°C | Channel '%c': Amp. filter temperature warning %d°C (power %uw) | Amp. temperature warning of output filters | Amp. | Poor cooling |
| 120 | CAN open error | Could not open CAN interface (error %d) | CAN interface open error | DSP | DSP defect or software error |

| Id | Error text | Eventlog text | Description | Location | Possible reasons |
|-----------|-------------------|--|--------------------|---------------------------------------|------------------------------------|
| 121 | CAN error | CAN error %d (remote flags %02X, dbCan flags %02X) | CAN error | Remote ID (External: CAN cabling), | CAN cabling or multiple Remote IDs |
| 122 | CAN warning | CAN warning %d (remote flags %02X, dbCan flags %02X) | CAN warning | (External: CAN cabling) | CAN cabling or multiple Remote IDs |

13. Operation (Hardware references)

13.1. Power supply

The device utilizes a switch mode power supply with active Power Factor Correction (PFC) and automatic mains range selection.

The power supply is equipped with mains voltage monitoring, overvoltage and undervoltage protection as well as an inrush current limiter.

13.1.1. Active Power Factor Correction (PFC)

The active Power Factor Correction provides a clean and highly efficient sinusoidal current draw, thus providing highest performance under adverse mains conditions or when very long power cabling is necessary.

The power factor is above 0.9 for mains power consumption values of 500 W or higher.

13.1.2. Automatic mains range selection

The automatic mains range selection enables the device to be used with any mains supply worldwide without the need for manual action.

| | |
|-------------------|---------------|
| High range | 208 - 240 VAC |
| Low range | 100 - 127 VAC |

Nominal mains ranges

Behavior with fluctuating mains voltages

With mains voltages other than the nominal voltages specified above, the device switches to the adequate mode for either 'Protection' or 'Operation'.

The voltage thresholds are dependent on the slope of the mains voltage change.

Undervoltage The Main Power Supply is switched off. In
Undefined undervoltage state, the auxiliary mains
Overvoltage supply for device control only operates to a
 limited extend.

| | | | | | | | | | | | |
|---------------------|---|------------------|----|------------------|-----|-------------------|-----|--------------------|-----|-------|-----|
| 0 | ← | 75 | ← | 133 | ← | 170 | ← | 266 | ← | ┌ 400 | |
| Undervoltage | | Low range | | Undefined | | High range | | Overvoltage | | | |
| Protection | | Operation | | Protection | | Operation | | Protection | | | |
| 0 | └ | ⇒ | 85 | ⇒ | 140 | ⇒ | 190 | ⇒ | 276 | ⇒ | 400 |

13.1.3. Mains voltage monitoring

The mains voltage and frequency are recorded by the power supply and can be viewed on screen. Where voltages outside of this range are present, a self-resetting protective circuit responds quickly to isolate the internal Main Power Supply leaving only a supervisory circuit running to monitor the mains voltage. The device accepts mains voltages of up to 400 VAC_{RMS} without damage to the device in case of a missing neutral line or running phase to phase.

13.1.4. Mains inrush current limiter

The Main Power Supply is started softly to limit inrush current. Up to two D80 may be powered up at the same time without triggering a line circuit breaker of 13-16 A (230 V) or 30 A (100-120 V) respectively. Inrush current is limited to:

- 13 A_{RMS} @ 230 VAC
- 22 A_{RMS} @ 120 VAC
- 27 A_{RMS} @ 100 VAC

13.1.5. Mains supply requirements

Due to the high power capability of the amplifier, properly dimensioned mains supply installation and distribution are essential.

However, the mains supply benefits from the built-in active PFC (Power Factor Correction) function of the amplifier, which causes an almost ideal (sinusoidal) current shape. Power losses of the mains supply and cables are kept to the lowest possible minimum.

Due to its automatic mains voltage selection, the amplifier can be fed from all usual mains voltages within the rated ranges as stated in ⇒ Chapter 13.1.2. "Automatic mains range selection" on page 66. Within these ranges, the mains voltage does not affect average output power figures due to the built-in regulated power supply. However, the dynamic character of common audio signals may cause short-time power peaks being twice as high as the average values. The resulting higher current draw causes an increased voltage drop on the mains line which may reduce the available output power if it gets too high.

To ensure safe and stable operation, observe the following recommendations and specifications:

- Operate a single amplifier on a 16 A circuit breaker at 208 to 240 V (high range) or on a 30 A circuit breaker at 100 to 127 V (low range).
- Operate the amplifier at a high-range supply (208 to 240 V), if possible. A low-range supply (100 to 127 V) requires a cable cross section that is 4 times higher to achieve comparable power performance.
- When three amplifiers are operated with a three-phase (120°) mains supply, the current on the N (neutral) conductor can be minimized by matching loads and signals between the three devices.
- Keep the supply line as short as possible and its cross section as high as possible, especially when operating the device at 100 to 127 V. Voltage drop at full load (30/15 A at 115/230 V) should not exceed 5 %. For reference specifications, refer to the following table.

| Maximum cable length for 5 % voltage drop at 3600 W mains power draw | | | | |
|---|---------------|---------------|---------------|----------------|
| Cable cross section | 100 V | 120 V | 208 V | 230 V |
| 1.3 mm ² - AWG 16 | Not permitted | Not permitted | 21 m/69 ft | 25 m/82 ft |
| 1.5 mm ² | Not permitted | Not permitted | 24 m/79 ft | 29 m/95 ft |
| 2.1 mm ² - AWG 14 | Not permitted | Not permitted | 33 m/108 ft | 40 m/131 ft |
| 2.5 mm ² | Not permitted | Not permitted | 40 m/131 ft | 49 m/161 ft |
| 3.3 mm ² - AWG 12 | 12 m/39.5 ft | 18 m/60 ft | 53 m/174 ft | 64 m/210 ft |
| 4.0 mm ² | 15 m/50 ft | 21 m/69 ft | 63 m/206.5 ft | 78 m/256 ft |
| 5.3 mm ² - AWG 10 | 19 m/62 ft | 28 m/92 ft | 83 m/272 ft | 102 m/334.5 ft |
| 6.0 mm ² | 22 m/72 ft | 32 m/105 ft | 95 m/312 ft | 116 m/380.5 ft |
| 8.4 mm ² - AWG 8 | 31 m/101 ft | 44 m/144 ft | 133 m/436 ft | 162 m/531.5 ft |

13.1.6. Generator operation/UPS requirements

To operate the amplifier using a mains generator or uninterruptible power supply (UPS), observe the following:

- With the D80 amplifier the apparent power figure (VA value) is about the same as the effective power figure (W value).
- Use a generator or UPS that can deliver the maximum power required by the entire system. Assume a short time power draw of kVA per D80. This is particularly important when using a UPS without dedicated short-time overload capability.
- Run the generator or UPS at 220 to 240 V, if available. 50 or 60 Hz is not an issue.

13.2. Power amplifiers

The power amplifiers fitted to the D80 utilize Class D technology similar to a switch mode power supply. Compared to the known linear amplifier concept (Class A, AB, G or H), Class D power amplifiers produce less heat and allow for a compact and light-weight design.

While supplying very high maximum output swing, it maintains high efficiency with any kind of signal and load and runs as cool as possible. Channels share the same power supply and are thermally coupled to provide even higher average power figures when unevenly loaded. TOP/SUB setups and active cardioid subwoofers are cases of typical use. A sophisticated circuit design decreases the impact of the load on the amplifier performance and enables a well defined sound reproduction. A comprehensive set of protection features individually prevents each channel from overload and/or damage/defect. Channels that are not affected will continue to operate, if safely possible.

13.3. Cooling fans

Three temperature and level controlled fans are incorporated for cooling the internal components, which allows greater cooling during louder program material. The fan speed is consequently reduced during quieter passages preventing background noise interference. If the unit heats up a «Temp. Warning» is issued and the fans will give full cooling power permanently.

13.4. Current/power draw and thermal dissipation

Measurement references

Signal CF 12 dB: Represents 1/8th of the nominal power.

Signal CF 9 dB: Represents 1/4th of the nominal power; power is limited to the nominal line current.

Continuous (cont.): Unlimited time. Thermal conditions may affect power figures.

Maximum (max.): Values are measured 1 sec. after signal was applied.

| 230 VAC / 50 Hz / 0.5 Ω Source impedance | | | | | | | | |
|---|-----------------|---------------------------|--------------|------------------|--------------------------|-----------------|-------------------------------|--------------------------------|
| Mode/Level | Load | Line current A_{RMS} | Power factor | Input power W | Output power (sum.) W | Power loss W | Thermal dissipation BTU/hr | Thermal dissipation kCal/hr |
| POWER switch off | - | 0.14 | 0.08 | 2 | 0 | 2 | 7 | 2 |
| Standby | - | 0.18 | 0.26 | 10 | 0 | 10 | 34 | 9 |
| On, idling | - | 0.85 | 0.83 | 162 | 0 | 162 | 553 | 139 |
| Signal CF 12 dB cont. | 4 Ω /Ch. | 12.50 | 0.98 | 2780 | 2150 | 630 | 2150 | 542 |
| Signal CF 9 dB cont. | 4 Ω /Ch. | 18.00 | 0.98 | 4140 | 3136 | 1004 | 3426 | 863 |
| Signal CF 9 dB max. | 4 Ω /Ch. | 24.00 | 0.98 | 5500 | 4000 | 1500 | - | - |

| 208 VAC / 60 Hz / 0.5 Ω Source impedance | | | | | | | | |
|---|-----------------|---------------------------|--------------|------------------|--------------------------|-----------------|-------------------------------|--------------------------------|
| Mode/Level | Load | Line current A_{RMS} | Power factor | Input power W | Output power (sum.) W | Power loss W | Thermal dissipation BTU/hr | Thermal dissipation kCal/hr |
| POWER switch off | - | 0.13 | 0.08 | 2 | 0 | 2 | 7 | 2 |
| Standby | - | 0.18 | 0.25 | 10 | 0 | 10 | 34 | 9 |
| On, idling | - | 0.93 | 0.82 | 160 | 0 | 160 | 546 | 138 |
| Signal CF 12 dB cont. | 4 Ω /Ch. | 13.80 | 0.98 | 2822 | 2150 | 672 | 2293 | 578 |
| Signal CF 9 dB cont. | 4 Ω /Ch. | 18.00 | 0.98 | 3635 | 2800 | 835 | 2849 | 718 |
| Signal CF 9 dB max. | 4 Ω /Ch. | 27.00 | 0.98 | 5600 | 4000 | 1600 | - | - |

| 120 VAC / 60 Hz / 0.2 Ω Source impedance | | | | | | | | |
|---|-----------------|--|---------------------|--------------------------|----------------------------------|-------------------------|---------------------------------------|--|
| Mode/Level | Load | Line current A_{RMS} | Power factor | Input power W | Output power (sum.) W | Power loss W | Thermal dissipation BTU/hr | Thermal dissipation kCal/hr |
| POWER switch off | - | 0.09 | 0.07 | 1 | 0 | 1 | 3 | 1 |
| Standby | - | 0.17 | 0.44 | 9 | 0 | 9 | 31 | 8 |
| On, idling | - | 1.57 | 0.89 | 168 | 0 | 168 | 573 | 144 |
| Signal CF 12 dB cont. | 4 Ω /Ch. | 25.50 | 0.98 | 3000 | 2150 | 850 | 2900 | 731 |
| Signal CF 9 dB cont. | 4 Ω /Ch. | 30.00 | 0.98 | 3600 | 2600 | 1000 | 3412 | 860 |
| Signal CF 9 dB max. | 4 Ω /Ch. | 54.00 | 0.99 | 6400 | 4000 | 2400 | - | - |

| 100 VAC / 60 Hz / 0.2 Ω Source impedance | | | | | | | | |
|---|-----------------|--|---------------------|--------------------------|----------------------------------|-------------------------|---------------------------------------|--|
| Mode/Level | Load | Line current A_{RMS} | Power factor | Input power W | Output power (sum.) W | Power loss W | Thermal dissipation BTU/hr | Thermal dissipation kCal/hr |
| POWER switch off | - | 0.08 | 0.07 | 1 | 0 | 1 | 2 | 0 |
| Standby | - | 0.17 | 0.50 | 9 | 0 | 9 | 31 | 8 |
| On, idling | - | 1.82 | 0.91 | 163 | 0 | 163 | 556 | 140 |
| Signal CF 12 dB cont. | 4 Ω /Ch. | 32.50 | 0.99 | 3250 | 2150 | 1100 | 3753 | 946 |
| Signal CF 9 dB cont. | 4 Ω /Ch. | 29.00 | 0.99 | 2900 | 2000 | 900 | 3071 | 774 |
| Signal CF 9 dB max. | 4 Ω /Ch. | 55.00 | 0.99 | 5500 | 3500 | 2000 | - | - |

14. Service/Maintenance and care

14.1. Service



CAUTION!

Potential risk of explosion.

The device incorporates a lithium battery which may cause danger of explosion if not replaced correctly.

- Refer replacement only to qualified service personnel authorized by d&b audiotechnik.
- Only replace with the same type of battery.

Do not open the device. No user serviceable parts inside. In case of any damage do not operate the device under any circumstances.

Refer servicing only to qualified service personnel authorized by d&b audiotechnik. In particular if:

- objects or liquids have entered the device.
- the device does not operate normally.
- the device was dropped or the housing is damaged.

14.2. Maintenance and care

Touch screen

If the touch screen requires cleaning ...:

- use a soft cloth only.
- do not use any solvent cleaners.

For cleaning very heavy dirt on the panel, it may be helpful to use a special cleaning spray for TFT screens. In this case proceed as follows:

1. Spray on the soft cloth before wiping the screen.
⇒ Never apply/spray directly on the screen as the liquid could penetrate the device.
2. Wipe the screen with moderate pressure.

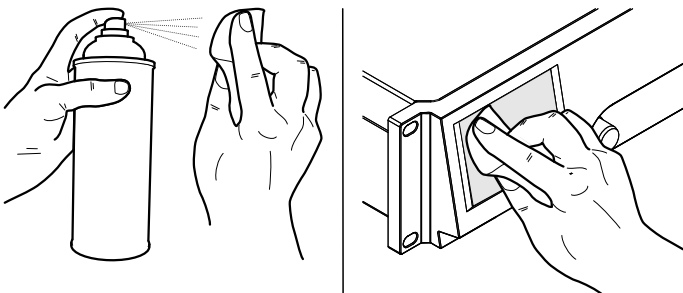



15.1. EU declaration of conformity (CE symbol)

This declaration applies to:

d&b D80 Amplifier, Z2710

manufactured by d&b audiotechnik GmbH.

All products of type D80 starting from variant Z2710.000 are included, provided they correspond to the original technical version and have not been subject to any later design or electromechanical modifications.

We herewith declare that said products are in conformity with the provisions of the respective EC directives including all applicable amendments.

A detailed declaration is available on request and can be ordered from d&b or downloaded from the d&b website at: www.dbaudio.com.

15.2. WEEE Declaration (Disposal)

Electrical and electronic equipment must be disposed of separately from normal waste at the end of its operational lifetime.

Please dispose of this product according to the respective national regulations or contractual agreements. If there are any further questions concerning the disposal of this product, please contact d&b audiotechnik.

15.3. Licenses and Copyright

This device includes software components released under different open source licenses. These components are supplied together with the d&b firmware.

A list of the components and a full-text version of all licenses and copyrights can be accessed using the amplifier's Web Remote interface as described in ⇒ Chapter 11. "Web Remote interface" on page 60.

⇒ Selecting the d&b logo at the top left of the «Web Remote» interface page opens the «Licenses and Copyright» information page.

This page provides an overview of the open source software used in this product. As required by the GPL and LGPL licenses, we will send you a copy of the used source code on request. If you would like to obtain a copy, please contact us by mail to:

d&b audiotechnik GmbH
Eugen-Adolff-Strasse 134, D-71522 Backnang, Germany
T +49-7191-9669-0, F +49-7191-95 00 00, info@dbaudio.com

or by email at: software.support@dbaudio.com

