

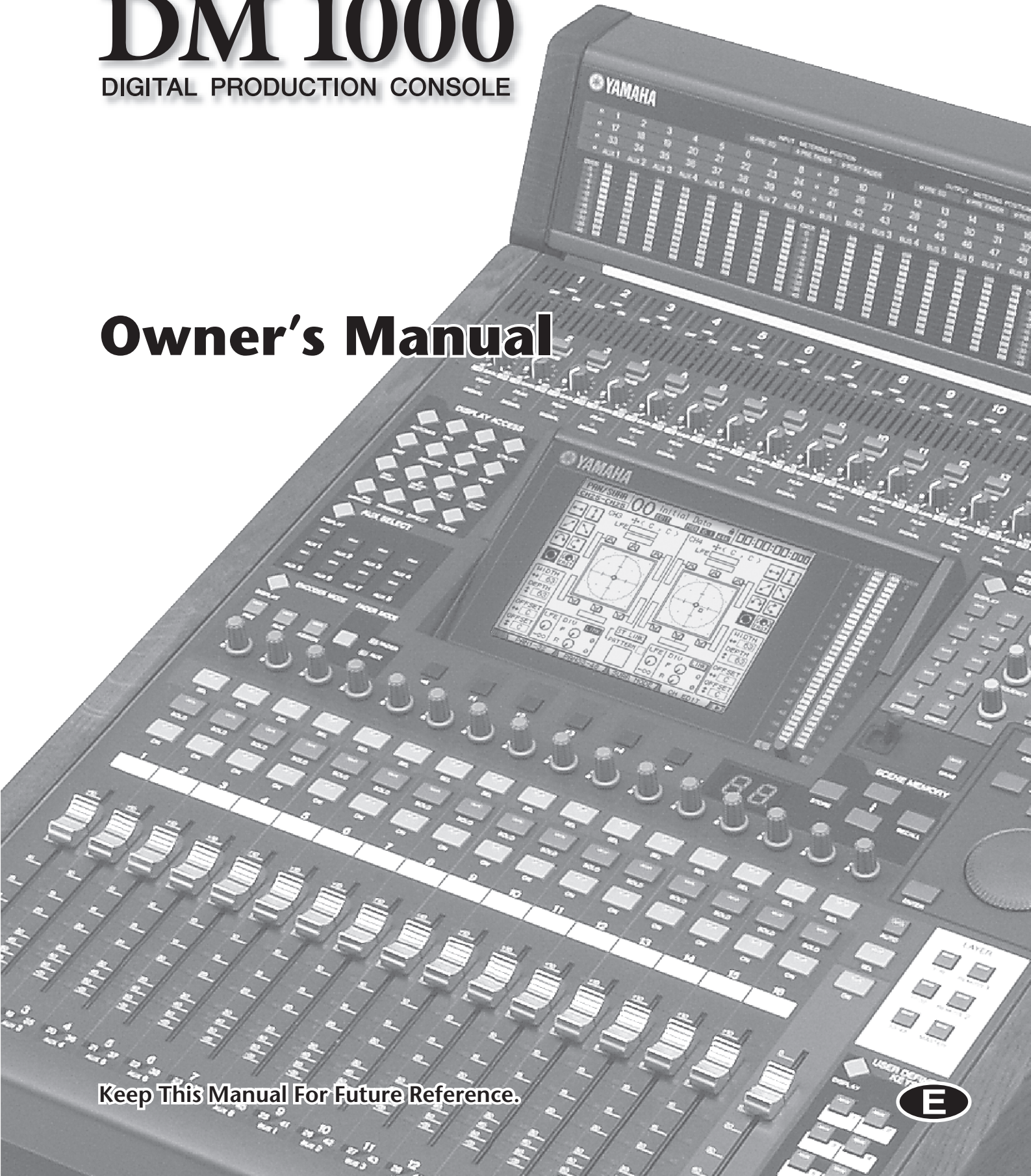

# DM 1000

DIGITAL PRODUCTION CONSOLE

## Owner's Manual



Keep This Manual For Future Reference.



## FCC INFORMATION (U.S.A.)

1. **IMPORTANT NOTICE: DO NOT MODIFY THIS UNIT!** This product, when installed as indicated in the instructions contained in this manual, meets FCC requirements. Modifications not expressly approved by Yamaha may void your authority, granted by the FCC, to use the product.
2. **IMPORTANT:** When connecting this product to accessories and/or another product use only high quality shielded cables. Cable/s supplied with this product **MUST** be used. Follow all installation instructions. Failure to follow instructions could void your FCC authorization to use this product in the USA.
3. **NOTE:** This product has been tested and found to comply with the requirements listed in FCC Regulations, Part 15 for Class "B" digital devices. Compliance with these requirements provides a reasonable level of assurance that your use of this product in a residential environment will not result in harmful interference with other electronic devices. This equipment generates/uses radio frequencies and, if not installed and used according to the instructions found in the users manual, may cause interference harmful to the operation of other electronic devices. Compliance with FCC regulations does not guarantee that interference will not occur in all installations. If this product is found to be the source of interference, which can be determined by turning the unit "OFF" and "ON", please try to eliminate the problem by using one of the following measures: Relocate either this product or the device that is being affected by the interference. Utilize power outlets that are on different branch (circuit breaker or fuse) circuits or install AC line filter/s. In the case of radio or TV interference, relocate/reorient the antenna. If the antenna lead-in is 300 ohm ribbon lead, change the lead-in to coaxial type cable. If these corrective measures do not produce satisfactory results, please contact the local retailer authorized to distribute this type of product. If you can not locate the appropriate retailer, please contact Yamaha Corporation of America, Electronic Service Division, 6600 Orangethorpe Ave, Buena Park, CA 90620

The above statements apply **ONLY** to those products distributed by Yamaha Corporation of America or its subsidiaries.

WARNING: THIS APPARATUS MUST BE EARTHED

### IMPORTANT

THE WIRES IN THIS MAINS LEAD ARE COLOURED IN ACCORDANCE WITH THE FOLLOWING CODE:

GREEN-AND-YELLOW : EARTH  
BLUE : NEUTRAL  
BROWN : LIVE

As the colours of the wires in the mains lead of this apparatus may not correspond with the coloured markings identifying the terminals in your plug, proceed as follows:

The wire which is coloured GREEN and YELLOW must be connected to the terminal in the plug which is marked by the letter E or by the safety earth symbol  $\perp$  or coloured GREEN and YELLOW.

The wire which is coloured BLUE must be connected to the terminal which is marked with the letter N or coloured BLACK.

The wire which is coloured BROWN must be connected to the terminal which is marked with the letter L or coloured RED.

ADVARSEL!

Lithiumbatteri—Eksplodingsfare ved fejlagtig håndtering. Udskiftning må kun ske med batteri af samme fabrikat og type. Levér det brugte batteri tilbage til leverandoren.

VARNING

Explosionsfara vid felaktigt batteribyte. Använd samma batterityp eller en ekvivalent typ som rekommenderas av apparattillverkaren. Kassera använt batteri enligt fabrikantens instruktion.

VAROITUS

Paristo voi räjähtää, jos se on virheellisesti asennettu. Vaihda paristo ainoastaan laitevalmistajan suosittelemaan tyyppiin. Hävitä käytetty paristo valmistajan ohjeiden mukaisesti.

\* This applies only to products distributed by YAMAHA KEMBLE MUSIC (U.K.) LTD.

## NEDERLAND

- Dit apparaat bevat een lithium batterij voor geheugen back-up.
- Raadpleeg uw leverancier over de verwijdering van de batterij op het moment dat u het apparaat aan het einde van de levensduur afdankt of de volgende Yamaha Service Afdeling:  
Yamaha Music Nederland Service Afdeling  
Kanaalweg 18-G, 3526 KL UTRECHT  
Tel. 030-2828425
- Gooi de batterij niet weg, maar lever hem in als KCA.

## THE NETHERLANDS

- This apparatus contains a lithium battery for memory back-up.
- For the removal of the battery at the moment of the disposal at the end of the service life please consult your retailer or Yamaha Service Center as follows:  
Yamaha Music Nederland Service Center  
Address: Kanaalweg 18-G, 3526 KL  
UTRECHT  
Tel: 030-2828425
- Do not throw away the battery. Instead, hand it in as small chemical waste.

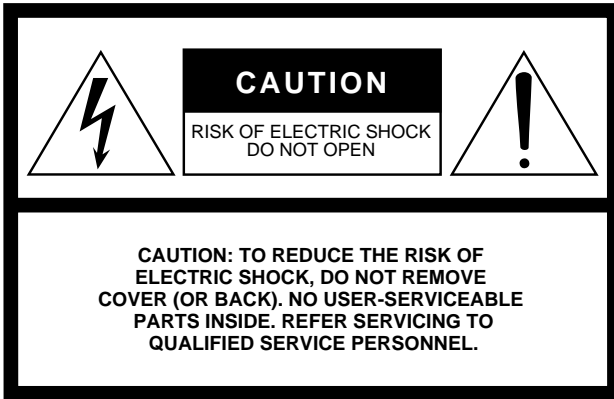

The above warning is located on the side of the unit

## • Explanation of Graphical Symbols

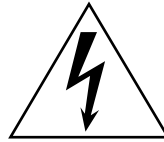

The lightning flash with arrowhead symbol within an equilateral triangle is intended to alert the user to the presence of uninsulated “dangerous voltage” within the product’s enclosure that may be of sufficient magnitude to constitute a risk of electric shock to persons.



The exclamation point within an equilateral triangle is intended to alert the user to the presence of important operating and maintenance (servicing) instructions in the literature accompanying the product.

# IMPORTANT SAFETY INSTRUCTIONS

- 1 Read these instructions.
- 2 Keep these instructions.
- 3 Heed all warnings.
- 4 Follow all instructions.
- 5 Do not use this apparatus near water.
- 6 Clean only with dry cloth.
- 7 Do not block any ventilation openings. Install in accordance with the manufacturer’s instructions.
- 8 Do not install near any heat sources such as radiators, heat registers, stoves, or other apparatus (including amplifiers) that produce heat.
- 9 Do not defeat the safety purpose of the polarized or grounding-type plug. A polarized plug has two blades with one wider than the other. A grounding type plug has two blades and a third grounding prong. The wide blade or the third prong are provided for your safety. If the provided plug does not fit into your outlet, consult an electrician for replacement of the obsolete outlet.
- 10 Protect the power cord from being walked on or pinched particularly at plugs, convenience receptacles, and the point where they exit from the apparatus.
- 11 Only use attachments/accessories specified by the manufacturer.
- 12 Use only with the cart, stand, tripod, bracket, or table specified by the manufacturer, or sold with the apparatus. When a cart is used, use caution when moving the cart/apparatus combination to avoid injury from tip-over.
- 13 Unplug this apparatus during lightning storms or when unused for long periods of time.
- 14 Refer all servicing to qualified service personnel. Servicing is required when the apparatus has been damaged in any way, such as power-supply cord or plug is damaged, liquid has been spilled or objects have fallen into the apparatus, the apparatus has been exposed to rain or moisture, does not operate normally, or has been dropped.



### WARNING

TO REDUCE THE RISK OF FIRE OR ELECTRIC SHOCK, DO NOT EXPOSE THIS APPARATUS TO RAIN OR MOISTURE.

# Important Information

---

## Warnings

- Connect this unit's power cord only to an AC outlet of the type stated in this Owner's Manual or as marked on the unit. Failure to do so is a fire and electrical shock hazard.
- Do not allow water to enter this unit or allow the unit to become wet. Fire or electrical shock may result.
- Do not place heavy objects, including this unit, on top of the power cord. A damaged power cord is a fire and electrical shock hazard. In particular, be careful not to place heavy objects on a power cord covered by a carpet.
- Do not place a container with liquid or small metal objects on top of this unit. Liquid or metal objects inside this unit are a fire and electrical shock hazard.
- Do not scratch, bend, twist, pull, or heat the power cord. A damaged power cord is a fire and electrical shock hazard.
- Do not remove the unit's cover. You could receive an electrical shock. If you think internal inspection, maintenance, or repair is necessary, contact your dealer.
- Do not modify the unit. Doing so is a fire and electrical shock hazard.
- If lightning begins to occur, turn off the power switch of the unit as soon as possible, and unplug the power cable plug from the electrical outlet.
- If there is a possibility of lightning, do not touch the power cable plug if it is still connected. Doing so may be an electrical shock hazard.
- Use only the included power cord for this unit. Using other types may be a fire and electrical shock hazard.
- This unit has rear-panel slots for installing mini-YGDAI cards. For technical reasons, certain card combinations are not supported. Before installing any cards, check the Yamaha web site (see page 6) to see whether your card is compatible. Also check the total number of cards that can be installed in the unit. Installing cards that are not endorsed by Yamaha may cause electrical shock, fire, or damage to the unit.
- If the power cord is damaged (i.e., cut or a bare wire is exposed), ask your dealer for a replacement. Using the unit with a damaged power cord is a fire and electrical shock hazard.
- If you notice any abnormality, such as smoke, odor, or noise, or if a foreign object or liquid gets inside the unit, turn it off immediately. Remove the power cord from the AC outlet. Consult your dealer for repair. Using the unit in this condition is a fire and electrical shock hazard.
- Should this unit be dropped or the cabinet be damaged, turn the power switch off, remove the power plug from the AC outlet, and contact your dealer. If you continue using the unit without heeding this instruction, fire or electrical shock may result.

## Cautions

- Keep this unit away from the following locations:
  - Locations exposed to oil splashes or steam, such as near cooking stoves, humidifiers, etc.
  - Unstable surfaces, such as a wobbly table or slope.
  - Locations exposed to excessive heat, such as inside a car with all the windows closed, or places that receive direct sunlight.
  - Locations subject to excessive humidity or dust accumulation.
- Hold the power cord plug when disconnecting it from an AC outlet. Never pull the cord. A damaged power cord is a potential fire and electrical shock hazard.
- Do not touch the power plug with wet hands. Doing so is a potential electrical shock hazard.

- This unit has ventilation holes along the front, rear, top, and sides to prevent the internal temperature from rising too high. Do not block them. Blocked ventilation holes are a fire hazard. In particular, do not operate the unit while it's on its side, is upside down, or while it's covered with a cloth or dust sheet.
- If you are using the optional MB1000 Peak Meter Bridge, do not hold only the MB1000 when moving this unit. Otherwise, the meter brackets may be damaged, the main unit may malfunction, or you may be injured if the unit falls.
- This unit is heavy. Use two or more people to carry it.
- When you transport or move this unit with the MB1000 attached, do not permit impact or stress on the cable connector that connects the MB1000 to this unit. Otherwise, malfunction may occur.
- This unit is equipped with a dedicated ground connection to prevent electrical shock. Before connecting the power plug to an AC outlet, be sure to ground the unit.
- To relocate the unit, turn the power switch off, remove the power plug from the AC outlet, and remove all connecting cables. Damaged cables may cause fire or electrical shock.
- If you know you will not use this unit for a long period of time, such as when going on vacation, remove the power plug from the AC outlet. Leaving it connected is a potential fire hazard.

## Operating Notes

- XLR-type connectors are wired as follows: pin 1—ground, pin 2—hot (+), and pin 3—cold (–).
- The performance of components with moving contacts, such switches, rotary controls, faders, and connectors, deteriorates over time. The rate of deterioration depends on the operating environment and is unavoidable. Consult your dealer about replacing defective components.
- Using a mobile telephone near this unit may induce noise. If noise occurs, use the telephone away from the unit.
- If the message “WARNING Low Battery!” appears when you turn on this unit, contact your dealer as soon as possible about replacing the internal data backup battery. The unit will still operate correctly, but data other than the presets will be lost.
- Before replacing the batteries, back up your data to a memory card, or another unit by using MIDI Bulk Dump.
- The digital circuits of this unit may induce a slight noise into nearby radios and TVs. If noise occurs, relocate the affected equipment.
- When connecting D-sub cables, be sure to tighten the screws on both sides of the connector securely. To disconnect the cable, loosen the screws completely, then remove the cable by holding the connector part. Do not remove the plug by pulling the cable while the screws are still attached. Otherwise, the connector may be damaged, leading to malfunction.
- When you change the wordclock settings on any device in your digital audio system, some devices may output noise, so turn down your power amps beforehand, otherwise your speakers may be damaged.

## Interference

This unit uses high-frequency digital circuits that may cause interference on radio and television equipment located nearby. If interference is a problem, relocate the affected equipment. Using a mobile telephone near the unit may induce noise. In this case use the telephone away from the unit.

## Exclusion of Certain Responsibility

Manufacturer, importer, or dealer shall not be liable for any incidental damages including personal injury or any other damages caused by improper use or operation of this unit.

## Trademarks

ADAT MultiChannel Optical Digital Interface is a trademark and ADAT and Alesis are registered trademarks of Alesis Corporation. Apogee is a trademark of Apogee Electronics, Inc. Apple, Mac, and Power Macintosh are registered trademarks and Mac OS is a trademark of Apple Corporation, Inc. HUI is a trademark of Mackie Designs, Inc. Intel and Pentium are registered trademarks of Intel Corporation. Nuendo is a registered trademark of Steinberg Media Technologies AG. Pro Tools is a trademark or registered trademark of Digidesign and/or Avid Technology, Inc. Tascam Digital Interface is a trademark and Tascam and Teac are registered trademarks of Teac Corporation. Microsoft and Windows are registered trademarks of Microsoft Corporation, Inc. Waves is a trademark of Waves, Inc. Yamaha is a trademark of Yamaha Corporation. All other trademarks are the property of their respective holders and are hereby acknowledged.

## Copyright

No part of this unit, its software, or this *Owner's Manual* may be reproduced or distributed in any form or by any means without the prior written authorization of Yamaha Corporation.

© 2003 Yamaha Corporation. All rights reserved.

## Yamaha Web Site

Further information about this unit, related products, and other Yamaha professional audio equipment is available on the Yamaha Professional Audio Web site at:  
<<http://www.yamahaproaudio.com/>>.

## Package Contents

- DM1000 Digital Production Console
- CD-ROM
- Power cord
- This manual
- Studio Manager Installation Guide

## Optional Extras

- MB1000 Peak Meter Bridge
- SP1000 Wooden Side Panels
- RK1 Rack Mount Kit
- mini YGDAI I/O cards

---

## About this Owner's Manual

This *Owner's Manual* explains how to operate the DM1000 Digital Production Console. The table of contents can help you familiarize yourself with the manual's organization and to locate tasks and topics. The index can help you locate specific information.

Before diving in, it's recommend that you read the "Operating Basics" chapter, starting on page 27.

Each chapter in this manual discusses a specific section or function of the DM1000. The Input and Output Channels are explained in the following chapters: "Input Channels," "Bus Outs," and "Aux Sends." Where possible, these chapters have been organized in order of signal flow, from input to output.

## Conventions Used in this Manual

The DM1000 features two types of buttons: physical buttons that you can press (e.g., ENTER and DISPLAY) and buttons that appear on the display pages. References to physical buttons are enclosed in square brackets, for example, "press the [ENTER] button." References to display page buttons are not emphasized, for example, "move the cursor to the ON button."

You can select display pages by using the [DISPLAY] buttons or the Left Tab Scroll, Right Tab Scroll, and F1–4 buttons below the display. In order to simplify explanations, the procedures reference only the [DISPLAY] button method. See "Selecting Display Pages" on page 28 for details on all the ways in which pages can be selected.

## Installing the DM1000

The DM1000 should be placed on a strong and stable surface, in a location that complies with the warnings and cautions listed in the previous sections.

Always turn the power off when the instrument is not in use.

The illustrations and LCD screens as shown in this owner's manual are for instructional purposes only, and may appear somewhat different from those on your instrument.

Copying of commercially available music sequence data and/or digital audio files is strictly prohibited except for your personal use.

# Contents

<b>1</b>	<b>Welcome</b> .....	<b>11</b>
<b>2</b>	<b>Control Surface &amp; Rear Panel</b> .....	<b>13</b>
	Control Surface .....	13
	Rear Panel .....	23
	Installing an Optional Card .....	26
<b>3</b>	<b>Operating Basics</b> .....	<b>27</b>
	About the Display .....	27
	Selecting Display Pages .....	28
	Display Interface .....	29
	Selecting Layers .....	31
	Selecting Channels .....	32
	Selecting Fader Modes .....	33
	Selecting Encoder Modes .....	34
	Assigning Parameters to the ENCODER MODE [ASSIGN] button .....	35
	Metering .....	37
<b>4</b>	<b>Connections and Setup</b> .....	<b>41</b>
	Connections .....	41
	Wordclock Connections and Settings .....	44
	Input and Output Patching .....	47
<b>5</b>	<b>Analog I/O &amp; Digital I/O</b> .....	<b>51</b>
	Analog Inputs & Outputs .....	51
	Digital Inputs & Outputs .....	52
	Converting Sampling Rates of Signals Received at 2TR Digital Inputs .....	53
	Monitoring Digital Input Channel Status .....	55
	Dithering Digital Outputs .....	56
	Setting the Transfer Format for Higher Sampling Rates .....	57
<b>6</b>	<b>Input Channels</b> .....	<b>59</b>
	About Input Channels .....	59
	Setting the Input Channels from the Display .....	60
	Setting the Input Channels from the Control Surface .....	71
	Pairing Input Channels .....	73
	Naming Input Channels .....	76
	Using MS Stereo Microphone .....	77
<b>7</b>	<b>Bus Outs</b> .....	<b>79</b>
	About Stereo Out .....	79
	Bus Out 1–8 .....	80
	Setting the Stereo Out and Bus Out 1–8 from the Display .....	81
	Setting the Stereo Out and Bus Out 1–8 from the Control Surface .....	86
	Pairing Buses or Aux Sends .....	87
	Attenuating Output Signals .....	88
	Naming the Stereo Out and Bus Outs .....	89
<b>8</b>	<b>Aux Sends</b> .....	<b>91</b>
	Aux Out 1–8 .....	91
	Setting Aux Out 1–8 from the Control Surface .....	92
	Setting Aux Out 1–8 from the Display .....	92
	Setting Aux Send Levels .....	96
	Viewing Aux Send Settings for Multiple Channels .....	100
	Panning Aux Sends .....	102
	Excluding Certain Channels from Aux Sends (Mix Minus) .....	103
	Copying Channel Fader Positions to Aux Sends .....	104



---

<b>9</b>	<b>Input &amp; Output Patching</b> .....	<b>105</b>
	Input Patching .....	105
	Output Patching .....	108
	Patching Direct Outs .....	111
	Insert Patching .....	112
<b>10</b>	<b>Control Room Monitoring</b> .....	<b>115</b>
	Control Room Monitor .....	115
	Control Room Monitor and Solo Setup .....	116
	Using the Control Room Monitor .....	118
	Using the Solo Function .....	118
	Using the Talkback Function .....	119
<b>11</b>	<b>Surround Functions</b> .....	<b>121</b>
	Using Surround Pan .....	121
	Surround Monitoring .....	131
<b>12</b>	<b>Grouping Channels &amp; Linking Parameters</b> .....	<b>141</b>
	Grouping & Linking .....	141
	Using Fader Groups and Mute Groups .....	142
	Linking EQ and Compressor Parameters .....	144
<b>13</b>	<b>Internal Effects</b> .....	<b>147</b>
	About the Internal Effects .....	147
	Using Effects Processors via Aux Sends .....	148
	Inserting the Internal Effects into Channels .....	150
	Editing Effects .....	151
	About Surround Effects .....	153
	About Plug-Ins .....	153
<b>14</b>	<b>Scene Memories</b> .....	<b>155</b>
	About Scene Memories .....	155
	Storing and Recalling Scenes .....	157
	Auto Scene Memory Update .....	159
	Fading Scenes .....	160
	Recalling Scenes Safely .....	162
	Sorting Scenes .....	163
<b>15</b>	<b>Libraries</b> .....	<b>165</b>
	About the Libraries .....	165
	General Library Operation .....	165
	Using Libraries .....	167
<b>16</b>	<b>Automix</b> .....	<b>181</b>
	About Automix .....	181
	Setting Up for Automix Recording .....	182
	Recording an Automix .....	184
	Punching In & Out .....	188
	[SEL] Button Functions While the [AUTO] Button Indicator Is On .....	190
	Playing Back an Automix .....	190
	Automix Main Page .....	191
	Automix Memory Page .....	195
	Fader1 & 2 pages .....	196
	Editing Events Offline .....	198
<b>17</b>	<b>Remote Control</b> .....	<b>205</b>
	About Remote Function .....	205
	Pro Tools Remote Layer .....	206
	Nuendo Remote Layer .....	224
	Other DAW Remote Layers .....	224
	MIDI Remote Layer .....	225
	Machine Control Function .....	231

---

---

<b>18 MIDI</b> .....	<b>235</b>
MIDI & the DM1000 .....	235
MIDI Port Setup .....	236
Assigning Scenes to Program Changes for Remote Recall .....	239
Assigning Parameters to Control Changes for Real-time Control .....	240
Controlling Parameters by Using Parameter Changes .....	246
Transmitting Parameter Settings via MIDI (Bulk Dump) .....	246
<b>19 Other Functions</b> .....	<b>249</b>
Changing the Input and Output Connector Names .....	249
Setting Preferences .....	250
Creating a Custom Layer by Combining Channels (User Assignable Layer) .....	255
Using the Oscillator .....	256
Using the User Defined Keys .....	257
Using GPI (General Purpose Interface) .....	259
Using Operation Lock .....	263
Cascading Consoles .....	265
Using the AD824 .....	270
Checking the Battery and the System Version .....	272
Initializing the DM1000 .....	273
Calibrating the Faders .....	274
<b>Appendix A: Parameter Lists</b> .....	<b>275</b>
USER DEFINED KEYS .....	275
USER DEFINED KEYS Initial Assignments .....	277
Input Patch Parameters .....	278
Initial Input Patch Settings .....	280
Output Patch Parameters .....	282
Initial Output Patch Settings .....	284
GPI Trigger Source List .....	286
User Defined Remote Layer Initial Bank Settings .....	287
Effects Parameters .....	291
Preset EQ Parameters .....	316
Preset Gate Parameters (fs = 44.1 kHz) .....	320
Preset Compressor Parameters (fs = 44.1 kHz) .....	320
<b>Appendix B: Specifications</b> .....	<b>325</b>
General Spec .....	325
Libraries .....	330
Analog Input Spec .....	330
Analog Output Spec .....	330
Digital Input Spec .....	331
Digital Output Spec .....	331
I/O Slot Spec (1–2) .....	332
Control I/O Spec .....	332
REMOTE Port .....	333
CONTROL Port .....	333
Dimensions .....	334
<b>Appendix C: MIDI</b> .....	<b>336</b>
Scene Memory to Program Change Table .....	336
Initial Parameter to Control Change Table .....	337
MIDI Data Format .....	353
<b>Appendix D: About Optional Product</b> .....	<b>368</b>
MB1000 Peak Meter Bridge .....	368
Installing the SP1000 Side Panels .....	371
Rack Mounting the DM1000 Using the RK1 Rack Mount Kit .....	371
<b>Index</b> .....	<b>372</b>

---

# 1 Welcome

Thank you for choosing the Yamaha DM1000 Digital Production Console.

The compact DM1000 Digital Console features 24-bit/96 kHz digital audio processing without compromise, as well as 48-channel simultaneous mixing. The DM1000 covers a broad range of needs and applications, including multi-track recording, 2-channel mix-down, and cutting-edge surround sound production. This integrated, comprehensive audio system features remote control function for DAWs (Digital Audio Workstations) as popularized by the DM2000 and 02R96 Digital Mixing Consoles.

The DM1000 offers the following features:

## ■ Hardware Features

- 17 touch-sensitive 100-mm motorized faders (for touch-sensitive selection of channels, or for punching in and out during Automix recording)
- Faders can set levels for Input Channels, Aux Sends, and Bus Outs.
- Rotary Encoders enable you to control panning for each channel, AUX send levels, and various parameters.
- Six selectable software layers determine the function of channel faders and Encoders.
- 320 x 240 dot LCD display with fluorescent backlighting
- Buttons and controls in the SELECTED CHANNEL section enable direct editing of channel mix parameters.
- 12 USER-DEFINED KEYS enable you to assign functions to control DM1000 internal parameters.
- Two expansion slots for optional digital I/O, AD, and DA cards.

## ■ Sonic Specifications

- Linear 24-bit, 128-times oversampling A/D converters
- Linear 24-bit, 128-times oversampling D/A converters
- 20 Hz through 40 kHz frequency response at 96 kHz sampling rate.
- 106 dB typical dynamic range
- 32-bit internal signal processing (58-bit accumulator)

## ■ Inputs and Outputs

- 16 mic/line inputs with switchable +48 V phantom power and 4 line inputs
- 12 Omni Outs assignable to Stereo Out, Bus Out, Monitor Out, and Input Channel Direct Outs.
- Two optional slots allow a maximum of 32 inputs.
- Two 2-track digital inputs, with sampling rate converters capable of converting sampling rates of 44.1 kHz through 96 kHz.
- Double Channel support for recording and playing at 88.2/96 kHz on 44.1/48 kHz legacy multi-track digital recorders.
- You can cascade two DM1000s while remaining in the digital domain.
- Input patches enable assignment of input signals to desired signal paths.
- Output patches enable assignment of Bus Out signals and Input Channel Direct Outs to desired output jacks.

**■ Channel Configuration**

- Simultaneous mixing of up to 48 Input Channels. Group multiple channels and pair channels for stereo.
- 8 Bus Outs and 8 AUX Sends. Buses 1-8 can be routed to Stereo Buses for use as Group Buses.
- Channel library for storing and recalling the channel settings for each Input Channel and Output Channel.
- 4-band EQ and dynamics processor equip all channels. Dynamics processor and EQ settings can be stored in libraries and recalled.

**■ Effects**

- Four high-quality multi-channel effects (Apply effects via AUX Sends or Channel Inserts).
- Effect library for storing and recalling effect settings.

**■ Scene Memory**

- Scene memories for storing and recalling the mix settings as Scenes.
- Snapshot style automation with Scene memories recallable via Automix.

**■ Surround Sound**

- Supports 3-1, 5.1, and 6.1 channel surround sound production.
- Joystick for adjusting each channel's surround pan.

**■ Automix**

- Automated controls of channel faders and parameters via Automix. (Even more powerful when combined with an MTR, DAW, and MIDI sequence system.)
- Control parameters of connected MIDI devices via Automix.

**■ Remote Control**

- Control and manage your DM1000 from your Mac or PC using bundled Studio Manager software
- Remote Layers for controlling popular DAWs (Digital Audio Workstations), including Pro Tools, Nuendo, etc.
- Control an external recorder via MMC commands and P2 commands.

**■ MIDI**

- Equipped with MIDI ports and a USB port for computer connection.
- Scene recall and mix parameter changes via MIDI

# 2 Control Surface & Rear Panel

## Control Surface

2

Control Surface & Rear Panel

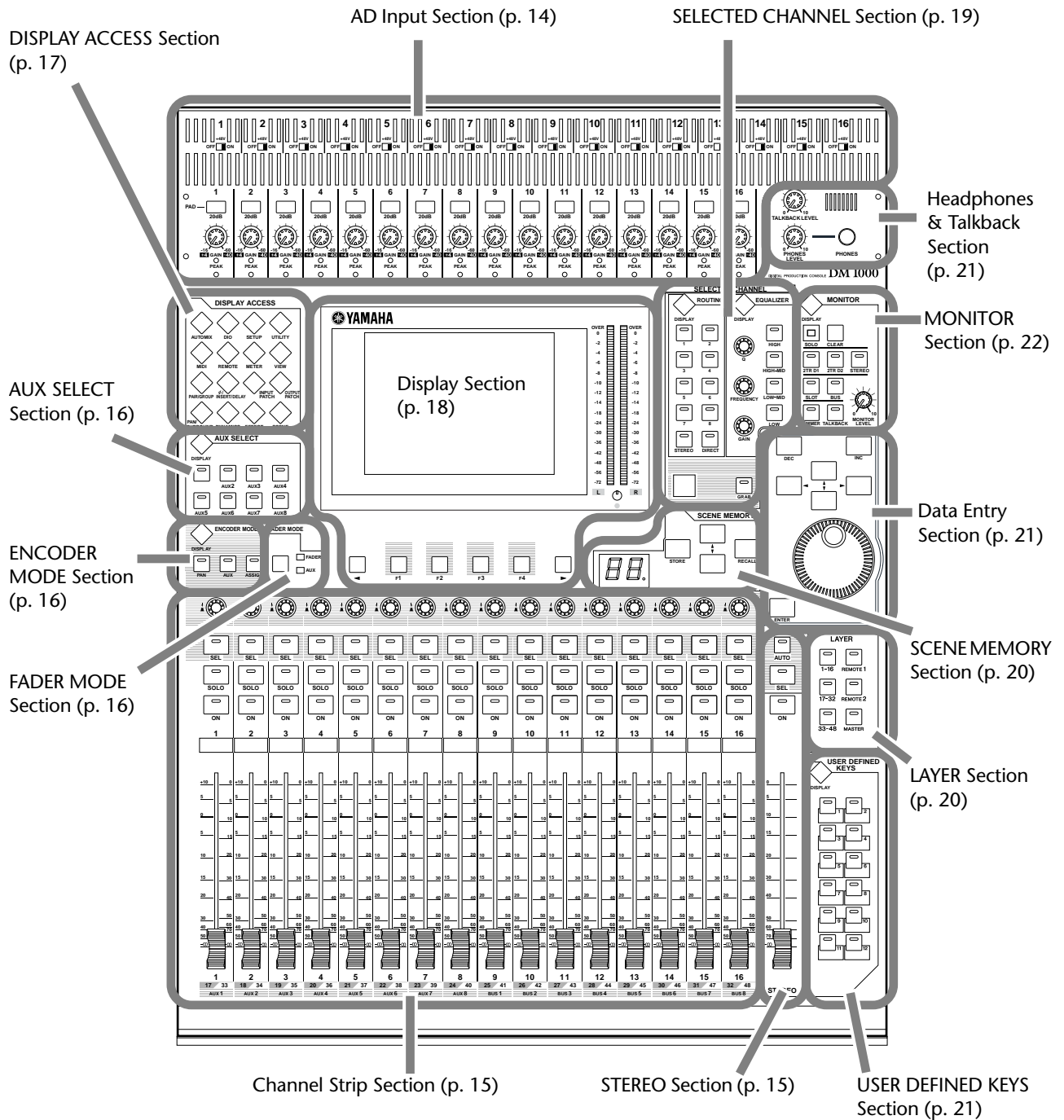

## AD Input Section

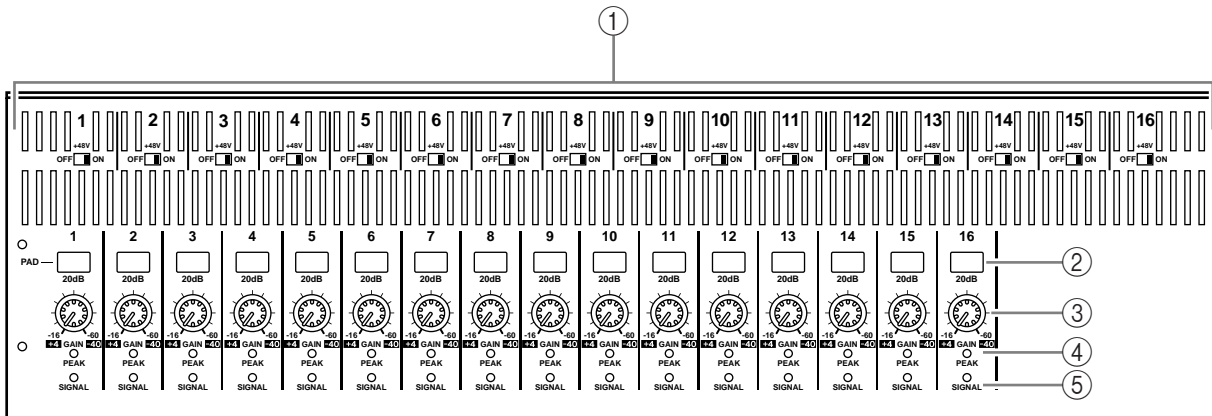

- ① **+48V ON/OFF switches 1–16**  
These switches turn on or off the +48 V phantom power feed to each INPUT.
- ② **PAD switches 1–16**  
These switches turn on or off the 20 dB pad (attenuator) for each AD Input.
- ③ **GAIN controls 1–16**  
These controls adjust input sensitivity for each AD Input. Input sensitivity is +4 dB to –40 dB when the Pad is on, and –16 dB to –60 dB when the Pad is off.
- ④ **PEAK indicators 1–16**  
These indicators light up when the input signal level is 3 dB below clipping. Adjust the Pad switch and GAIN control so that the indicator rarely lights up at signal peak.
- ⑤ **SIGNAL indicators**  
These indicators light up when the input signal level is 20 dB below nominal.

## Channel Strip Section

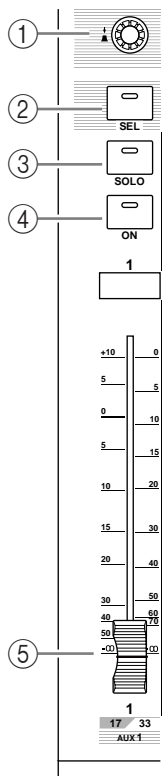

### ① Encoders 1–16

These rotary Encoders adjust the channel parameter settings. Depending on the button selected in the ENCODER MODE section (see page 16), the Encoders will adjust the channel pan setting (when the ENCODER MODE [PAN] button indicator is lit), the AUX Send level (when the ENCODER MODE [AUX] button indicator is lit), or any parameter (when the ENCODER MODE [ASSIGN] button indicator is lit).

These Encoders also feature push switches that are used to view the value of the parameter currently assigned to the Encoder, or to punch in or out during Automix recording.

### ② [SEL] buttons 1–16

These buttons enable you to select desired channels. The [SEL] button indicator for the currently-selected channel lights up. The channel selected by each [SEL] button depends on the currently-selected button in the LAYER section (see page 20).

These buttons also allow you to select channels for Automix recording and playback, create or cancel channel pairs, and add channels to (or remove them from) Fader, Mute, EQ, and Compressor groups.

### ③ [SOLO] buttons 1–16

These buttons solo the selected channels. The [SOLO] button indicator of the currently-soloed channel lights up.

### ④ [ON] buttons 1–16

These buttons turn the selected channels on or off. The [ON] button indicators for On channels light up.

### ⑤ Channel faders 1–16

These are touch-sensitive 100 mm motorized faders. Depending on the button selected in the FADER MODE Section (see page 16), the faders will adjust the input or output level of the selected channels or buses, or adjust the AUX Send level.

## STEREO Section

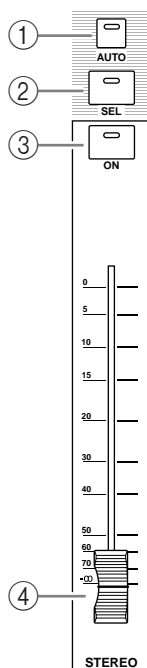

### ① [AUTO] button

When this button is turned on, you can use the [SEL] buttons 1–16 to turn the Automix function on or off.

### ② [SEL] button

Selects the Stereo Bus.

### ③ [ON] button

Turns the selected bus on or off.

### ④ [STEREO] fader

This touch-sensitive 100 mm motorized fader adjusts the final output level of the Stereo Bus.

## AUX SELECT Section

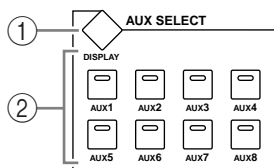

- ① **[DISPLAY] button**  
This button displays an Aux-related page (see page 97).
- ② **[AUX 1]–[AUX 8] buttons**  
These buttons select an Aux Send. When you press a button to select an AUX Send, the corresponding button indicator lights up.

## ENCODER MODE Section

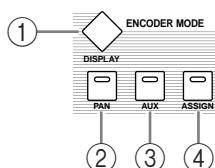

- ① **[DISPLAY] button**  
This button displays an Encoder page, enabling you to assign functions to Encoders 1–16 (see page 35). To use a function assigned to an Encoder, press the [ASSIGN] button to turn on the button indicator.
- ② **[PAN] button**  
If you press this button, the button indicator turns on and Encoders 1–16 function as channel panpots.
- ③ **[AUX] button**  
If you press this button, the button indicator turns on and Encoders 1–16 function as channel Aux Send. The Send destination is selected in the AUX SELECT Section.
- ④ **[ASSIGN] button**  
If you press this button, the button indicator turns on and Encoders 1–16 function as assignable controls for the parameters assigned on the Encoder pages. (By default, Input Patches of the corresponding Input Channels are assigned.)

## FADER MODE Section

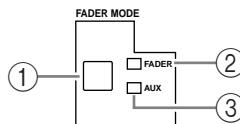

- ① **[FADER/AUX] button**  
Toggles between the desired parameter to be adjusted by channel faders 1–16. The faders adjust the Channel or Bus level when the FADER indicator is lit, and adjust the Aux Send level when the AUX indicator is lit.
- ② **FADER indicator**
- ③ **AUX indicator**  
An indicator lights up to indicate the parameter selected via the [FADER/AUX] button.



## DISPLAY ACCESS Section

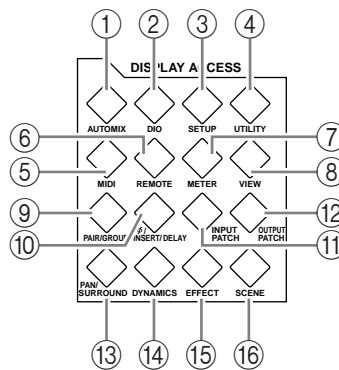

- ① **[AUTOMIX] button**  
This button displays an Automix page, enabling you to make Automix settings (see page 181).
- ② **[DIO] button**  
This button displays a DIO page, enabling you to make digital I/O settings (see page 53).
- ③ **[SETUP] button**  
This button displays a Setup page, enabling you to make the DM1000 internal settings.
- ④ **[UTILITY] button**  
This button displays a Utility page, enabling you to use the internal oscillators and view information about installed optional cards.
- ⑤ **[MIDI] button**  
This button displays a MIDI page, enabling you to make MIDI settings (see page 238).
- ⑥ **[REMOTE] button**  
This button displays a Remote page, enabling you to control a DAW remotely and make machine control settings (see page 205).
- ⑦ **[METER] button**  
This button displays a Meter page, which displays Input Channel levels, or Bus Out or Aux Send Out levels (see page 37).
- ⑧ **[VIEW] button**  
This button displays a View page, enabling you to view and set mix parameters for a specific channel (see page 69).
- ⑨ **[PAIR/GROUP] button**  
This button displays a Pair/Group page, enabling you to pair channels, group multiple faders, or mute channels (see page 74 and 141).
- ⑩ **[ $\phi$ /INSERT/DELAY] button**  
This button displays a  $\phi$ /INS/DLY page, enabling you to switch the signal phase, set the signal to be inserted, or set the delay parameters (see page 60 and 150).
- ⑪ **[INPUT PATCH] button**  
This button displays an In Patch page, enabling you to patch input signals and Bus Out signals to the desired Input Channels (see page 105).
- ⑫ **[OUTPUT PATCH] button**  
This button displays an Out Patch page, enabling you to patch Bus Out and Insert Out signals to the desired destination (see page 108).
- ⑬ **[PAN/SURROUND] button**  
This button displays a Pan/Surr page, enabling you to adjust stereo or surround pan settings (see page 67 and 121).

- ⑭ **[DYNAMICS] button**  
This button displays a Dynamics page, enabling you to control channel gates and compressors (see page 62).
- ⑮ **[EFFECT] button**  
This button displays an Effect page, enabling you to edit the internal effects processors and use optional plug-in cards (see page 151).
- ⑯ **[SCENE] button**  
This button displays a Scene page, enabling you to store and recall Scenes (see page 155).

## Display Section

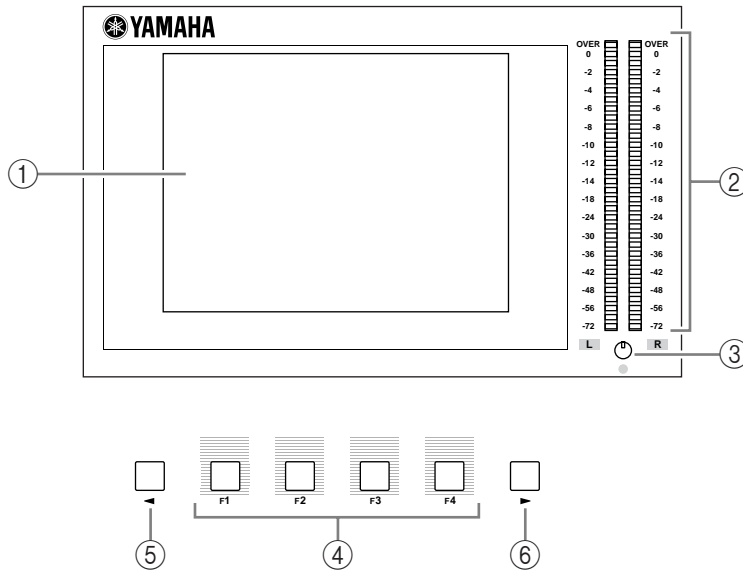

- ① **Display**  
This is a 320 x 240 dot LCD display with a fluorescent backlight.
- ② **Stereo meters**  
These 32-segment level meters display the final output level of the Stereo Bus.
- ③ **Contrast control**  
This control adjusts the display contrast.
- ④ **[F1]–[F4] buttons**  
These buttons select a page from a multi-page screen. Selecting a tab at the bottom of the screen using one of these buttons displays the corresponding page. (See page 28 for more information on displaying a page.)
- ⑤ **Left Tab Scroll [ ◀ ] button**
- ⑥ **Right Tab Scroll [ ▶ ] button**  
If there are more pages available than the four whose tabs are currently displayed, use these buttons to display the additional tabs. These buttons are available only when the left or right Tab Scroll arrow appears.

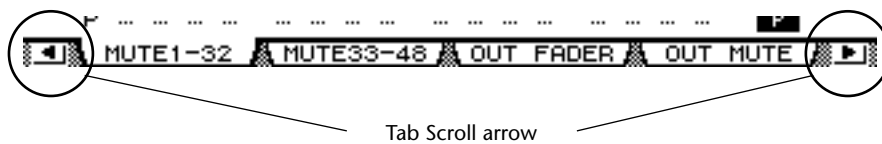

## SELECTED CHANNEL Section

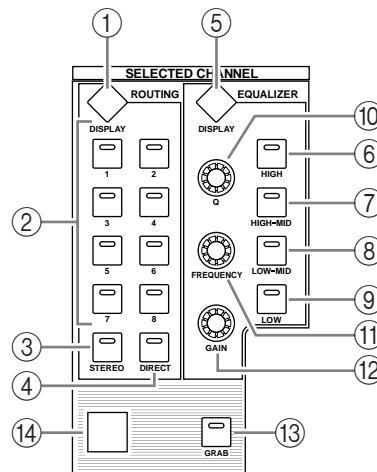

- ① **ROUTING [DISPLAY] button**  
This button displays a Routing page, enabling you to route selected channels to the desired Bus, and adjust the level of the signals routed from Buses 1–8 to the Stereo Bus (see page 68 and 83).
- ② **ROUTING [1]–[8] buttons**
- ③ **ROUTING [STEREO] button**
- ④ **ROUTING [DIRECT] button**  
These buttons select the desired Bus for routing the selected Input Channel signals. The corresponding button indicator for the currently-selected Bus lights up.
- ⑤ **EQUALIZER [DISPLAY] button**  
This button displays an EQ page, enabling you to set the selected channel equalizer (see page 64 and 65).
- ⑥ **EQUALIZER [HIGH] button**
- ⑦ **EQUALIZER [HIGH-MID] button**
- ⑧ **EQUALIZER [LOW-MID] button**
- ⑨ **EQUALIZER [LOW] button**  
These buttons select the EQ band (HIGH, HIGH-MID, LOW-MID, LOW). The corresponding button indicator of the currently-selected band lights up.
- ⑩ **EQUALIZER [Q] control**  
This control adjusts the currently-selected band Q.
- ⑪ **EQUALIZER [FREQUENCY] control**  
This control adjusts the currently-selected band frequency.
- ⑫ **EQUALIZER [GAIN] control**  
This control adjusts the currently-selected band gain.
- ⑬ **[GRAB] button**  
This button enables Joystick control of the surround pan setting for the currently-selected Input Channel. This button can be turned on only when the surround pan setting is available.
- ⑭ **Joystick**  
The Joystick is used to set the surround pan position (see page 126).

## LAYER Section

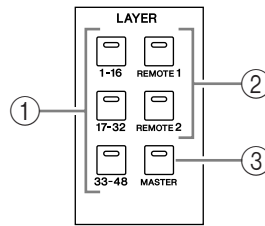

- ① **[1-16]/[17-32]/[33-48] buttons**  
These buttons select an Input Channel Layer. The channel strips control Channels 1–16, 17–32, or 33–48, depending on the button selected here. (See page 31 for more information on Layers.)
- ② **[REMOTE 1]/[REMOTE 2] buttons**  
These buttons select the Remote Layer, which can be used to control external devices, including DAWs. (See page 205 for more information on the Remote Layer.)
- ③ **[MASTER] button**  
This button selects the Master Layer, which can be used to control Bus and Aux Send. (See page 31 for more information on the Master Layer.)

## SCENE MEMORY Section

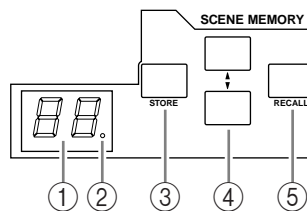

- ① **Scene memory display**  
The number of the currently-selected Scene memory is displayed here.
- ② **Edit indicator**  
If you adjust a mix parameter after a Scene has been recalled or stored, a dot flashes here.
- ③ **[STORE] button**  
This button enables you to store the current mix settings (See page 155 for more information on Scene Memories).
- ④ **Scene Up [▲] / Down [▼] buttons**  
These buttons select a Scene to store or recall. Pressing the Scene Up [▲] button increments the selection; pressing the Scene Down [▼] button decrements the selection. Holding down either key increments or decrements the selection continuously.
- ⑤ **[RECALL] button**  
This button recalls the Scene memory selected by the Scene Up [▲] / Down [▼] buttons.

## USER DEFINED KEYS Section

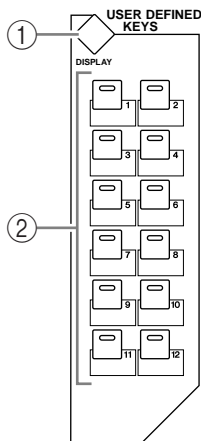

- ① **[DISPLAY] button**  
This button displays a User Def page, enabling you to assign functions to buttons 1–12 (see page 257).
- ② **[1]–[12] buttons**  
These buttons perform the functions assigned in the User Def pages.

## Data Entry Section

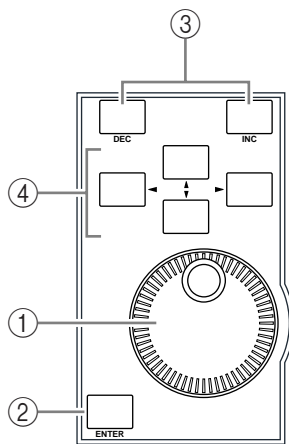

- ① **Parameter wheel**  
This control adjusts the parameter values shown on the display. Turning it clockwise increases the value; turning it counterclockwise decreases the value. This wheel also enables you to scroll a displayed list and select a character for entry (see page 30).
- ② **[ENTER] button**  
This button activates a selected (highlighted) button on the display, and confirms the edited parameter values.
- ③ **[DEC] & [INC] buttons**  
These buttons increment or decrement a parameter value by one. Pressing the [INC] button increments the value; pressing the [DEC] button decrements the value. Holding down either key increments or decrements the value continuously.
- ④ **Left, Right, Up, Down ([◀]/[▶]/[▲]/[▼]) cursor buttons**  
These buttons move the cursor around the display pages, or select parameters and options. Holding down a cursor button moves the cursor continuously in the respective direction.

## Headphones & Talkback Section

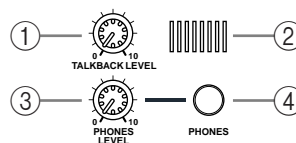

- ① **TALKBACK LEVEL control**  
This control sets the level of the built-in talkback microphone. (See page 119 for more information on the Talkback function.)
- ② **Talkback mic**  
This built-in microphone is used for talkback.
- ③ **PHONES LEVEL control**  
This control sets the level of the PHONES. (See page 115 for more information on monitoring through the headphones.)
- ④ **PHONES jack**  
You can connect a set of stereo headphones to this stereo phone jack.

## MONITOR Section

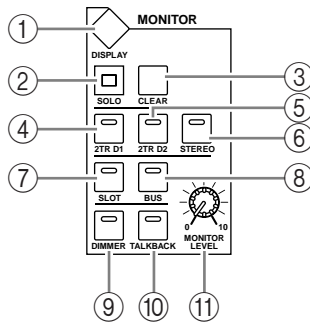

① **[DISPLAY] button**

This button displays a Monitor page, enabling you to adjust monitor settings (see page 115 and 131).

② **[SOLO] indicator**

This indicator flashes when a single or multiple channels are soloed.

③ **[CLEAR] button**

This button “unsolos” all soloed Channels.

④ **[2TR D1] button**

⑤ **[2TR D2] button**

⑥ **[STEREO] button**

These buttons select the Control Room Monitor output signal. When the [2TR D1] button indicator is lit, the signal at the 2TR OUT DIGITAL 1 jack is selected. When the [2TR D2] button indicator is lit, the signal at the 2TR OUT DIGITAL 2 jack is selected. When the [STEREO] button indicator is lit, the Stereo Bus signal is selected.

If you change the parameter setting on the Monitor | Solo/C-R page (see page 116), you can monitor the OMNI IN signal, instead of the 2TR IN DIGITAL signal, when you press the [2TR D1] or [2TR D2] button.

⑦ **[SLOT] button**

⑧ **[BUS] button**

These buttons select the Surround Monitor signal source. When the [BUS] button indicator is lit, the Bus 1–8 signals are selected. When the [SLOT] button indicator is lit, the signals from Slots 1/2 are selected. (See page 131 for more information on the Surround Monitor.)

⑨ **[DIMMER] button**

This button activates the Dimmer function, which lowers the Monitor and Surround Monitor signals. This function is convenient when you wish to talk in the control room during mixdown. The [TALKBACK] button indicator flashes while the Talkback function is active (see page 116).

⑩ **[TALKBACK] button**

This button turns on the Talkback function. While the button indicator is lit, the Talkback mic signal is sent to any desired Bus or Slot (see page 119).

⑪ **MONITOR LEVEL control**

This control adjusts the monitor level.

*Note:*

- The DM1000 allows you to patch source signals to any output jack (other than the PHONES jack). Therefore, the console does not feature a dedicated monitor output jack. Instead, you can route monitoring signals to any desired output jack (typically to OMNI OUT jacks 1–12).
- By default, monitoring signals are assigned to OMNI OUT jacks 11 and 12.

## Rear Panel

### AD Input and Output Section (p. 23)

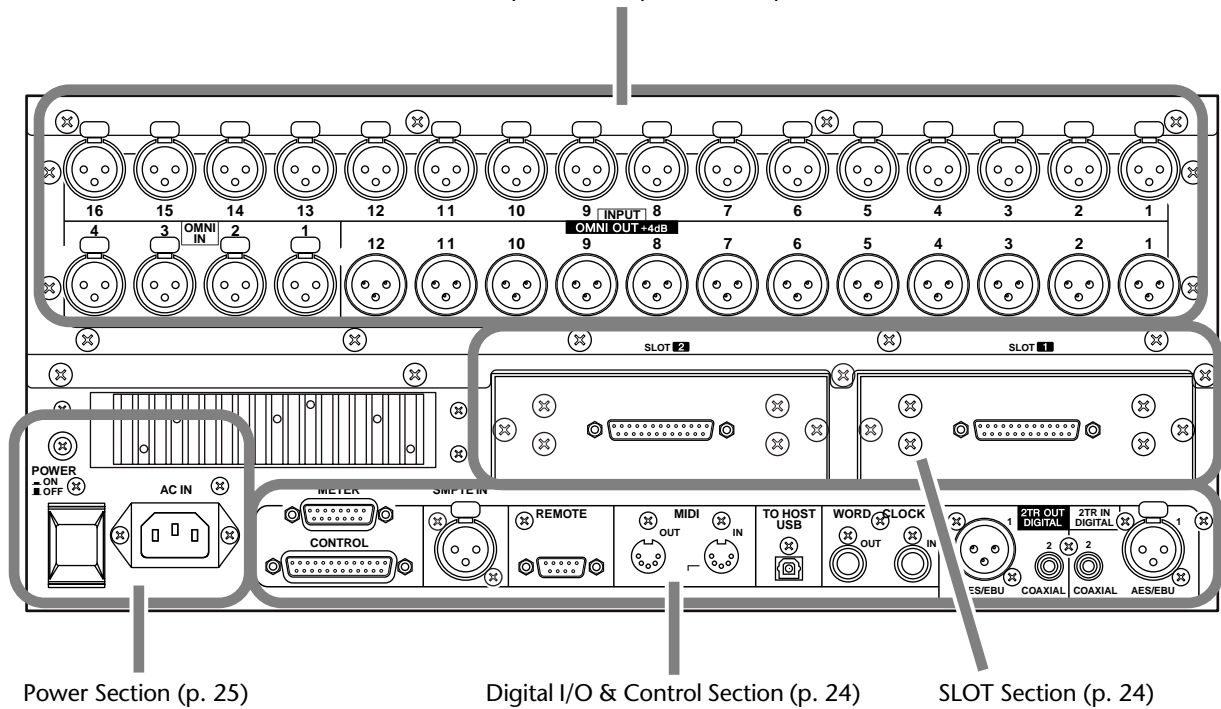

2

Control Surface &amp; Rear Panel

## AD Input and Output Section

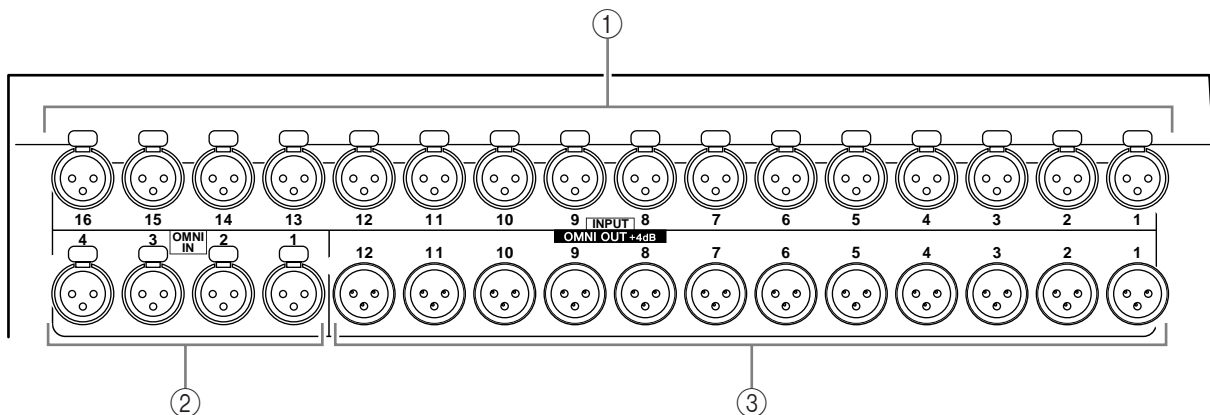

### ① INPUT connectors 1–16

These balanced XLR-3-31-type connectors accept line-level and microphone signals. The nominal signal level ranges from  $-60$  dB through  $+4$  dB.

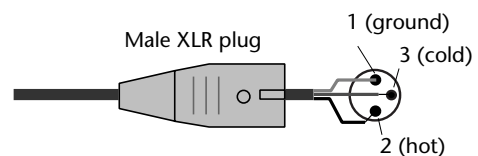

### ② OMNI IN connectors 1–4

These balanced XLR-3-31-type connectors accept line-level signals. The nominal signal level is  $+4$  dB.

### ③ OMNI OUT connectors 1–4

These balanced XLR-3-32-type connectors output any Bus signals and channel Direct Out signals. The nominal signal level is  $+4$  dB.

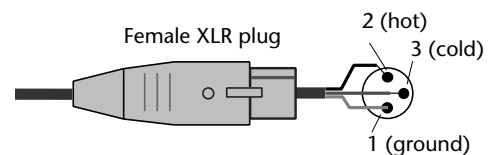

## SLOT Section

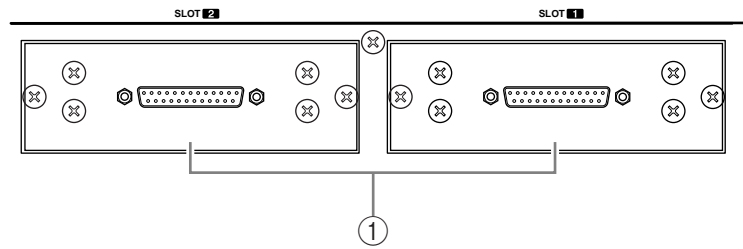

① **SLOT 1 & 2**

You can insert optional mini-YGDAI cards into these slots. (See page 26 for more information on installing these cards.)

## Digital I/O & Control Section

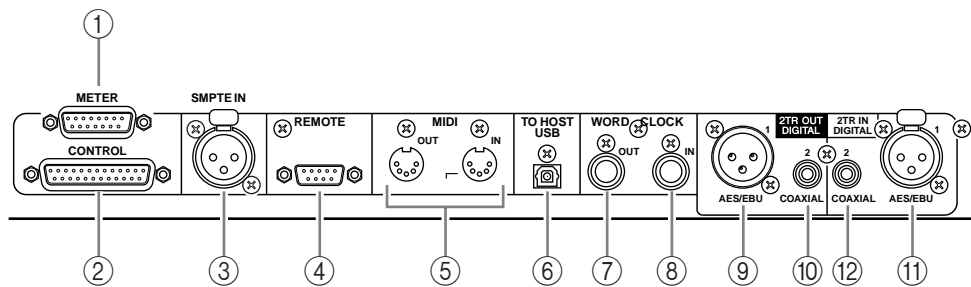

① **METER connector**

This connector enables you to connect an optional MB1000 Meter Bridge.

② **CONTROL connector**

This 25-pin D-sub connector provides access to the GPI (General Purpose Interface). Through this connector, the Talkback function can be turned on and off from external equipment, or external equipment can be started or stopped from the DM1000 (see page 259).

③ **SMPTE TIME CODE INPUT connector**

This balanced XLR-3-31-type connector is used to input SMPTE timecode to synchronize the Automix function.

④ **REMOTE connector**

This 9-pin D-Sub connector is used to remotely control external equipment that supports the Yamaha AD824 and Sony P2 Protocol (remote control commands that are used on TASCAM DA-98HR and other professional video recorders). Use a reverse cable to connect an AD824, and use a straight cable to connect a P2 Protocol device. Use a reverse cable to connect two DM1000s to each other. Connecting two DM1000s to each other enables communication via MIDI Protocol and SOLO Logic synchronization.

⑤ **MIDI IN & OUT ports**

These standard MIDI IN and OUT ports enable you to connect the DM1000 to other MIDI equipment.

⑥ **TO HOST USB port**

This USB port enables you to connect a computer equipped with a USB port.

⑦ **WORD CLOCK OUT connector**

This BNC connector outputs a wordclock signal from the DM1000 to a connected external device.



**⑧ WORD CLOCK IN connector**

This BNC connector inputs a wordclock signal from a connected external device to the DM1000.

**⑨ 2TR OUT DIGITAL AES/EBU 1**

This XLR-3-31-type connector outputs AES/EBU format digital audio. The connector is typically used to connect the digital stereo input (AES/EBU format) of a DAT recorder, MD recorder, or CD recorder.

**⑩ 2TR OUT DIGITAL COAXIAL 2**

This phono connector outputs consumer format (IEC-60958) digital audio. The connector is typically used to connect the digital stereo input (consumer format) of a DAT recorder, MD recorder, or CD recorder.

**⑪ 2TR IN DIGITAL AES/EBU 1**

This XLR-3-32-type connector accepts AES/EBU format digital audio. The connector is typically used to connect the digital stereo output (AES/EBU format) of a DAT recorder, MD recorder, or CD recorder.

**⑫ 2TR IN DIGITAL COAXIAL 2**

This phono connector accepts consumer format (IEC-60958) digital audio. The connector is typically used to connect the digital stereo output (consumer format) of a DAT recorder, MD recorder, or CD recorder.

## Power Section

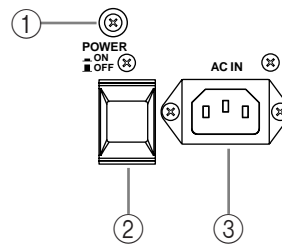
**① Grounding screw**

Be sure to use this screw to ground the DM1000 to protect yourself against electrical shock. The supplied power cord features a three-pin plug. If the ground terminal of the AC outlet is grounded, then the unit will be grounded sufficiently via the power cord. If the AC outlet does not provide a suitable ground, this screw must be connected to a suitable ground point. Grounding is also an effective method for eliminating hum, interference, and other noise.

**② POWER ON/OFF switch**

This switch turns the power to the DM1000 on or off.

*Note: To prevent loud clicks and thumps in your speakers, turn on your audio equipment in the following order (reverse this order when turning off)—sound sources, multitrack and master recorders, DM1000, monitoring power amplifiers.*

**③ AC IN connector**

This connector enables you to connect the DM1000 to an AC outlet via the supplied power cord.

## Installing an Optional Card

Visit the following Yamaha Pro Audio web site to ensure that the card you are installing is supported by the DM1000. Also, verify the number of cards (including other Yamaha or third-party cards) that can be installed in the unit.

<<http://www.yamahaproaudio.com/>>.

Follow the steps below to install an optional mini-YGDAI card.

- 1 Make sure that the power to the DM1000 is turned off.**
- 2 Undo the two fixing screws and remove the slot cover, as shown below.**  
Keep the cover and fixing screws in a safe place for future use.

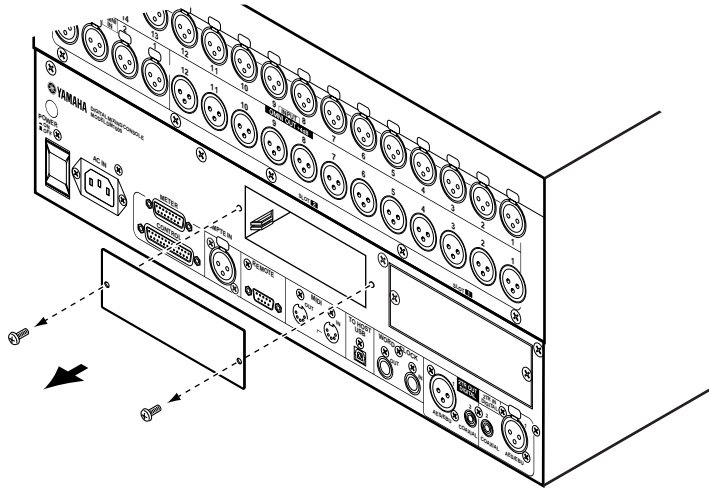

- 3 Insert the card between the guide rails and slide it all the way into the slot, as shown below.**

You may have to push firmly to fully insert the card into the internal connector.

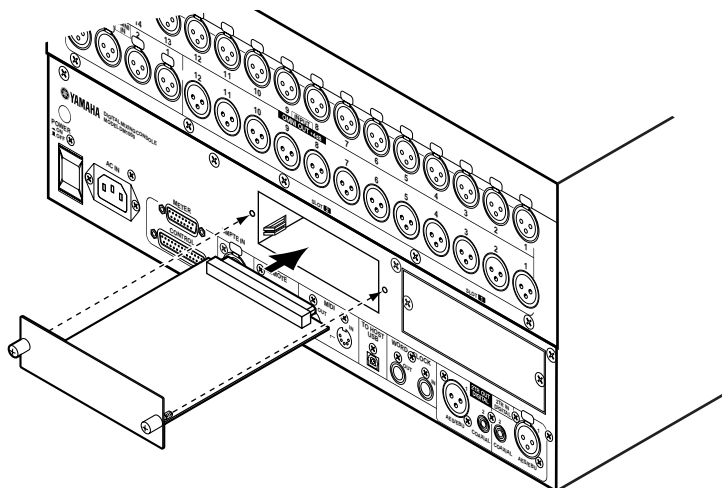

- 4 Secure the card using the attached thumbscrews.**

Tighten the screws firmly, or else the card may not be grounded correctly, which may cause the DM1000 to malfunction.

## 3 Operating Basics

This chapter describes basic operations on the DM1000, including how to use the display and operate the controls on the top panel.

### About the Display

The top panel display indicates various parameters that you must set before you can operate the DM1000. The display indicates the following items:

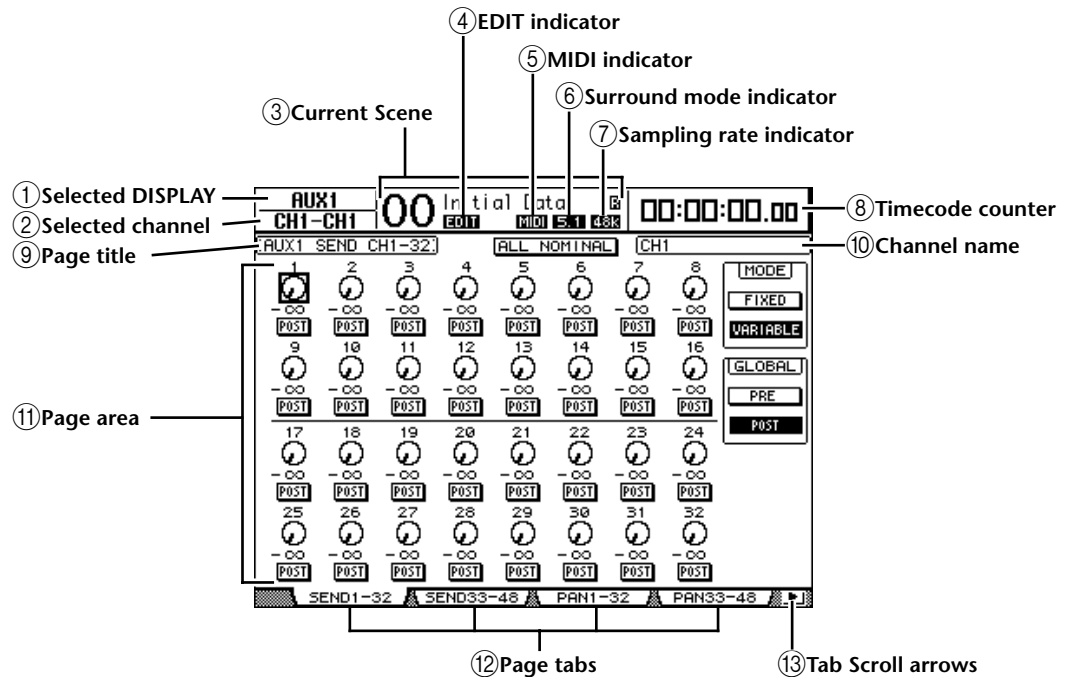

#### ① Selected DISPLAY

This section indicates the currently-selected display page group.

#### ② Selected channel

This section indicates the Input or Output Channel currently selected by its corresponding [SEL] button or fader. The first four characters are the Channel ID (e.g., CH1-CH48, BUS1-BUS8, AUX1-AUX8, ST-L, ST-R). The second four characters are the channel's Short name. You can edit the channel's Short name if you desire (see page 76 and 89).

#### ③ Current Scene

This section indicates the number and title of the currently-selected Scene memory (see page 156). If the selected Scene is write-protected, a padlock icon (🔒) appears.

#### ④ EDIT indicator

This indicator appears when the current mix settings no longer match those of the Scene that was most-currently recalled. It works in unison with the Edit indicator dot on the Scene Memory display.

#### ⑤ MIDI indicator

This indicator appears when the DM1000 is receiving MIDI data via the MIDI IN port, USB port, REMOTE connector, or an installed MY8-mLAN card.

**⑥ Surround mode indicator**

This indicator identifies the currently-selected Surround mode (ST=stereo, 3-1, 5.1, or 6.1) (see page 121).

**⑦ Sampling rate indicator**

This indicator identifies the DM1000's current sampling rate: 44.1 kHz (44k), 48 kHz (48k), 88.2 kHz (88k), or 96 kHz (96k).

**⑧ Timecode counter**

This counter displays the current position in the MIDI timecode being received via the MIDI IN port, USB port, REMOTE connector, or an installed MY8-mLAN card. It works in unison with the timecode counter on an optional MB1000 Meter Bridge.

If MIDI clock is selected as the timecode source on the Setup | Time Ref page, this counter indicates the current MIDI clock position in bars:beats:clocks.

**⑨ Page title**

This section indicates the title of the current page.

**⑩ Channel name**

Depending on which page is currently selected, the channel name is the Long name of the channel currently selected by its corresponding [SEL] button or the cursor buttons.

**⑪ Page area**

This page area displays various page contents.

**⑫ Page tabs**

These tabs enable you to select a display page.

**⑬ Tab Scroll arrows**

These arrows indicate that more pages are available.

## Selecting Display Pages

To select a display page:

**1 Press the corresponding button on the top panel to select the desired page group.**

Display pages are grouped by function. To select a page group, press the [DISPLAY] button in the following sections: AUX SELECT, ENCODER MODE, ROUTING, EQUALIZER, MONITOR, USER DEFINED KEY. You can select additional page groups by pressing the desired button in the DISPLAY ACCESS section.

**2 You can select pages that have currently-displayed tabs by pressing the [F1]–[F4] buttons.**

If the selected display page group contains multiple pages, press the [F1]–[F4] buttons below the corresponding tab to select a specific page.

**3 To select a page for which a tab is not currently displayed, press either the Left or Right [◀]/[▶] Tab Scroll button (depending on where the page is located) to display the page tab, then press the corresponding [F1]–[F4] button.**

If display page groups contain more than four pages, either the left or right arrow appears. To display the currently-hidden tabs, press the Right or Left [◀]/[▶] Tab Scroll button.

You can also select a page from a page group as follows:

- **Selecting the next page in a page group:**

Press the button you selected in Step 1 repeatedly. This enables you to select a page that has a hidden tab.

- **To select the previous page in a page group:**  
Press and hold down the button you selected in Step 1. The screen steps back through the pages one by one. Release the button when the desired page is displayed. This enables you to select a page that has a hidden tab.
  - **To select the first page in the group:**  
Double-click the button you selected in Step 1.
- 4 Press the cursor buttons to move the cursor (a bold frame) to a button, parameter box, rotary control, or fader so that you can change the value.**

**Tip:** The DM1000 remembers the current page and parameter when you select a new page group. If you return to the previous page group, the DM1000 displays the correct page, with the same parameter selected. You can also select a page by using the controls or buttons on the top panel (see page 250).

## Display Interface

This section describes how to use the display interface.

### Rotary Controls & Faders

The rotary controls and faders enable you to adjust the continuously variable parameter values, including Input Channel levels and effects parameters. Press the cursor buttons to move the cursor to a rotary control or fader you want to adjust, then rotate the Parameter wheel or press the [INC]/[DEC] buttons to modify the value.

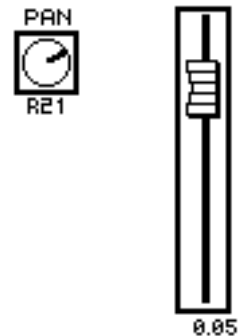

### Buttons

The buttons enable you to turn certain functions on (enabled) or off (disabled). Move the cursor to the appropriate button, then press the [ENTER] button to turn the function on (highlighted) or off. The buttons also enable you to select one of two options or to execute certain functions.



### Parameter Boxes

The parameter boxes enable you to select one of multiple options. Press the cursor buttons to move the cursor to a parameter box, then rotate the Parameter wheel or press the [INC]/[DEC] buttons to select the setting.

You may need to press the [ENTER] button to confirm the change of certain parameter box. If you edit a value in this type of parameter boxes, the value flashes. Press the [ENTER] button to confirm the change, and the flashing stops. If you move the cursor to other parameters while the edited value is flashing, the edit is cancelled.

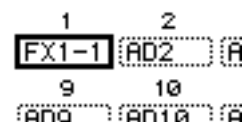

## Confirmation Messages

For certain functions, the DM1000 prompts you for confirmation before executing the functions, as shown here.

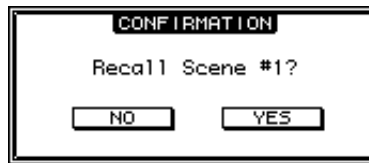

Move the cursor to YES and press [ENTER] to execute the function, or move the cursor to NO and press [ENTER] to cancel.

If you take no action for awhile, the confirmation window closes automatically and the function is not executed.

## Title Edit Window

The Title Edit window enables you to enter titles for Scene and library memories, Auto-mixes, and so on. You can enter 4, 12, or 16 characters, depending on the item.

The figure on the left shows uppercase characters and various punctuation marks. The figure on the right shows lowercase characters and numbers.

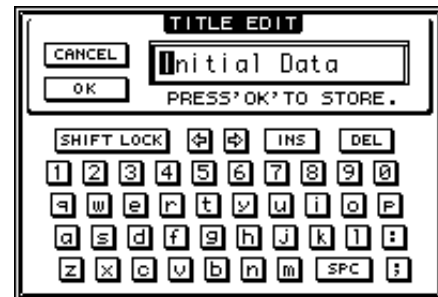
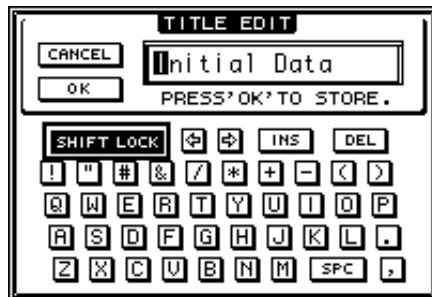

Use the cursor buttons to select characters, and press the [ENTER] button to enter them into the title. The cursor moves to the right automatically as each character is entered. Use the Parameter wheel or the Left and Right cursor buttons to move the cursor within the title. Use the SHIFT LOCK button to select uppercase or lowercase characters, and use the SPC button to enter a space.

To insert a space at the cursor position and move subsequent characters to the right, move the cursor to the INS button and press [ENTER].

To delete the character at the cursor position and move subsequent characters to the left, move the cursor to the DEL button and press [ENTER].

When you have finished, move the cursor to the OK button, then press [ENTER] to confirm the title. To cancel the title entry, move the cursor to the CANCEL button, then press [ENTER].

## Selecting Layers

Input Channels and Output Channels (Bus Outs & Aux Outs) are arranged into layers, as illustrated below. There are six layers altogether.

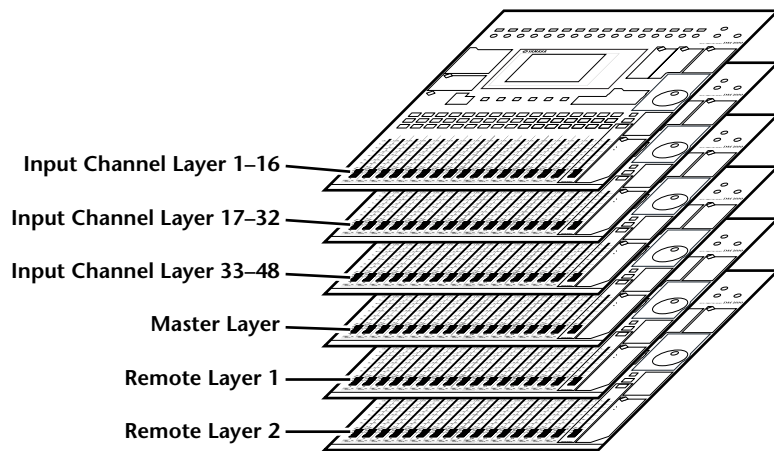

The currently-selected layer determines the function of the channel strip Encoders, [SEL] buttons, [SOLO] buttons, [ON] buttons, and faders. Use the LAYER buttons to select a layer you wish to edit using the channel strip controls.

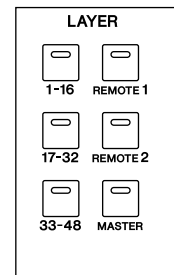

The following table shows the layers that you can access using the LAYER buttons, and the parameters you can control using the channel strips on each layer.

LAYER buttons	Layers	Channel Strips	
		1-8	9-16
[1-16] button	Input Channel Layer 1-16	Input Channels 1-16	
[17-32] button	Input Channel Layer 17-32	Input Channels 17-32	
[33-48] button	Input Channel Layer 33-48	Input Channels 33-48	
[REMOTE 1] button	Remote Layer 1	Operation depends on the selected target (see page 205).	
[REMOTE 2] button	Remote Layer 2		
[MASTER] button	Master Layer	Aux Send masters 1-8	Bus Out masters 1-8

**Tip:** The function of each channel strip fader and Encoder depends on the currently-selected Fader mode (see page 33) and Encoder mode (see page 34) respectively.

## Selecting Channels

The SELECTED CHANNEL controls enable you to edit main mix parameters for a channel selected from the Input Channels and Output Channels (Aux Outs, Bus Outs, and Stereo Out).

To select a channel for editing using the SELECTED CHANNEL controls, follow the steps below:

- 1 Press the corresponding LAYER button to select a layer that includes the desired channel (see page 31).
- 2 Use the corresponding [SEL] button or fader to select the desired Input or Output Channel.

The channel is selected and the [SEL] button indicator lights up.

If the Fader Touch Sense parameter is enabled on the Setup | Prefer2 page (see page 252), operating a fader selects the corresponding channel.

The Channel's ID and Short name appear in the upper-left corner of the display. If the currently-displayed page contains a relevant channel parameter, the cursor moves to that parameter automatically. If the currently-displayed page contains no such parameter, a page that does contain such a parameter is selected automatically.

**Tip:** For paired Input or Output Channels, the channel for which you pressed the [SEL] button is selected, and its indicator lights up. The [SEL] button indicator of the paired partner flashes.

- 3 To select the Stereo Out, press the STEREO [SEL] button or touch the [STEREO] fader.

Repeatedly pressing the STEREO [SEL] button toggles between the Stereo Out left and Stereo Out right channels.

If the currently-displayed page contains a relevant Stereo Out parameter, the cursor moves to that parameter automatically. If the currently-displayed page contains no such parameter, a page that does contain such a parameter is selected automatically.

**Tip:** If the Auto Channel Select parameter is enabled on the Setup | Prefer1 page (see page 250), operating a fader or Encoder, or turning on a [SOLO] or [ON] button selects the corresponding channel.

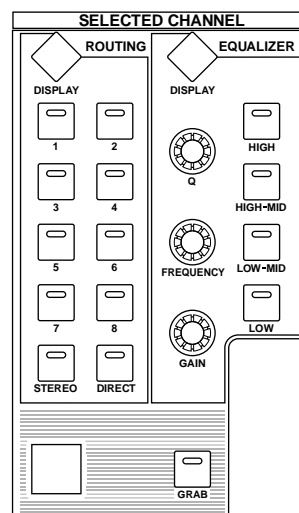



## Selecting Fader Modes

The function of channel faders (1–16) depends on the selected Layer and Fader mode.

**1 Select a layer that includes the desired channel (see page 31).**

**2 Press the FADER MODE [FADER/AUX] button to select a Fader mode.**

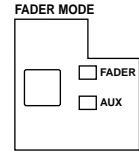

- **When the [FADER] indicator lights up:** ..... You can use channel faders to control Input Channel levels or Output Channel (Aux Out 1–8, Bus Out 1–8) master levels.
- **When the [AUX] indicator lights up:** ..... You can use channel faders to control Input Channel Aux Send levels.

The following table shows the channel fader functions for each Layer and Fader mode.

LAYER buttons	Fader Mode	Channel Strip Fader	
		1–8	9–16
[1-16] button	Fader	Input Channels 1–16 level	
	Aux	Input Channels 1–16 Aux Send level	
[17-32] button	Fader	Input Channels 17–32 level	
	Aux	Input Channels 17–32 Aux Send level	
[33-48] button	Fader	Input Channels 33–48 level	
	Aux	Input Channels 33–48 Aux Send level	
[REMOTE 1] button	Fader	Operation depends on the selected target (see page 205).	
	Aux	No operation	No operation
[REMOTE 2] button	Fader	Operation depends on the selected target (see page 205).	
	Aux	No operation	No operation
[MASTER] button	Fader	Aux Send master 1–8 output level	Bus Out master1–8 output level
	Aux	No operation	No operation

**Note:** You cannot select Aux mode while the Master layer is selected. If you switch to the Master layer while the FADER MODE [AUX] indicator is lit, the indicator automatically turns off and the [FADER] indicator lights up.

## Selecting Encoder Modes

The function of Encoders (1–16) depends on the selected Layer and Encoder mode.

**1 Select a layer that includes the desired channel (see page 31).**

**2 Press the corresponding ENCODER MODE button to select an Encoder mode.**

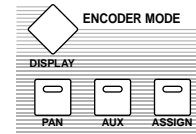

- **When the [PAN] button indicator lights up:** .....Encoders 1–16 function as Pan controls for the selected layer.
- **When the [AUX] button indicator lights up:** .....Encoders 1–16 function as Aux Send level controls for the selected layer.
- **When the [ASSIGN] button indicator lights up:** .....Encoders control the parameters assigned to the [ASSIGN] button for the selected layer. (See the next section for more information on how to assign parameters to the [ASSIGN] button.)

The following table shows the Encoder functions for each Layer and Encoder mode.

LAYER buttons	Encoder Mode	Channel Strip Encoder	
		1–8	9–16
[1-16] button	Pan	Input Channels 1–16 pan	
	Aux	Input Channels 1–16 Aux Send level	
	Assign	Assigned parameter	
[17-32] button	Pan	Input Channels 17–32 pan	
	Aux	Input Channels 17–32 Aux Send level	
	Assign	Assigned parameter	
[33-48] button	Pan	Input Channels 33–48 pan	
	Aux	Input Channels 33–48 Aux Send level	
	Assign	Assigned parameter	
[REMOTE 1] button	Pan	Operation depends on the selected target (see page 205).	
	Aux		
	Assign		
[REMOTE 2] button	Pan		
	Aux		
	Assign		
[MASTER] button	Pan	No operation	
	Aux		
	Assign	Assigned parameter	

## Assigning Parameters to the ENCODER MODE [ASSIGN] button

While the ENCODER MODE [ASSIGN] button indicator is lit, you can use Encoders 1–16 to control a parameter assigned to the [ASSIGN] button. Follow the steps below to assign a parameter to the [ASSIGN] button.

### 1 Press the ENCODER MODE [DISPLAY] button.

The Encoder | Encoder page appears. The name of the parameter currently assigned to the [ASSIGN] button is displayed in the left-hand box. All assignable parameters are displayed in the right-hand box. (The parameter currently assigned to the button is highlighted in the right-hand box.)

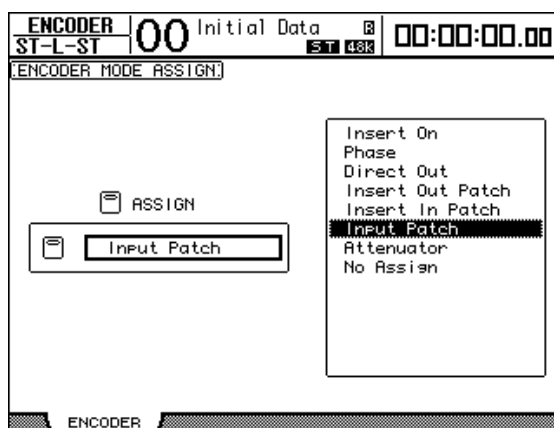

### 2 Use the Parameter wheel or press the [INC]/[DEC] buttons to select a parameter in the right-hand box.

A parameter is selected when it appears inside the dotted box. Refer to the next page for a complete list of assignable parameters.

### 3 Press [ENTER] to confirm the assignment.

Once assigned, press the ENCODER MODE [ASSIGN] button to turn on the button indicator. You can now use Encoders 1–16 to control the assigned parameter.

**Note:** When channels that do not feature the currently-assigned parameter are selected, the Encoders are inactive. For example, if the assigned Encoder parameter is “Phase,” and the Master layer is selected, Encoders are inactive, because the Aux Sends and Bus Outs do not feature Phase parameters.

- Assignable Encoder Mode Parameter List

#	Parameters	Encoder Operation	Push Switch Operation
1	No Assign	—	—
2	Attenuator	Attenuator	Display the settings.
3	Input Patch	Input Channel patch	Confirm patch selection.
4	Insert In Patch	Insert In patch	
5	Insert Out Patch	Insert Out patch	
6	Direct Out	Direct Out patch	
7	Phase:	Phase: normal/reverse	
8	Insert On	Insert on/off	
9	Aux pre/post	Aux pre/post	Display the settings.
10	Delay On	Delay on/off	
11	Delay Time	Delay Time	
12	Delay FB.Gain	Delay FB.Gain	
13	Delay Mix	Delay Mix	
14	EQ On	EQ on/off	
15	EQ Type	EQ Type	
16	EQ Low Q	EQ Low Q	
17	EQ Low F	EQ Low Frequency	
18	EQ Low G	EQ Low Gain	
19	EQ Low-Mid Q	EQ Low-Mid Q	
20	EQ Low-Mid F	EQ Low-Mid Frequency	
21	EQ Low-Mid G	EQ Low-Mid Gain	
22	EQ High-Mid Q	EQ High-Mid Q	
23	EQ High-Mid F	EQ High-Mid Frequency	
24	EQ High-Mid G	EQ High-Mid Gain	
25	EQ High Q	EQ High Q	
26	EQ High F	EQ High Frequency	
27	EQ High G	EQ High Gain	
28	Gate On	Gate on/off	
29	Gate Threshold	Gate Threshold	
30	Gate Range	Gate Range	
31	Gate Attack	Gate Attack	
32	Gate Decay	Gate Decay	
33	Gate Hold	Gate Hold	
34	Comp On	Comp on/off	
35	Comp Threshold	Comp Threshold	
36	Comp Ratio	Comp Ratio	
37	Comp Attack	Comp Attack	
38	Comp Release	Comp Release	
39	Comp Out Gain	Comp Out Gain	
40	Comp Knee/Width	Comp Knee/Width	
41	Surr L/R Pan	Surr L/R Pan	
42	Surr F/R Pan	Surr F/R Pan	
43	Surr Front DIV	Surr Front DIV	
44	Surr Rear DIV	Surr Rear DIV	
45	Surr LFE Level	Surr LFE Level	
46	Surr Pan Wheel	Surr Pan Wheel	
47	Scene Fade Time	Scene Fade Time	
48	AD824 Gain	AD824 Gain	
49	Ins AD824 Gain	Ins AD824 Gain	

# Metering

This section describes how to check Input and Output Channel levels using the Meter pages or an optional MB1000 Peak Meter Bridge.

- 1 Press the DISPLAY ACCESS [METER] button repeatedly until the Meter | Position page appears.

This page enables you to set the metering position for Input and Output Channels.

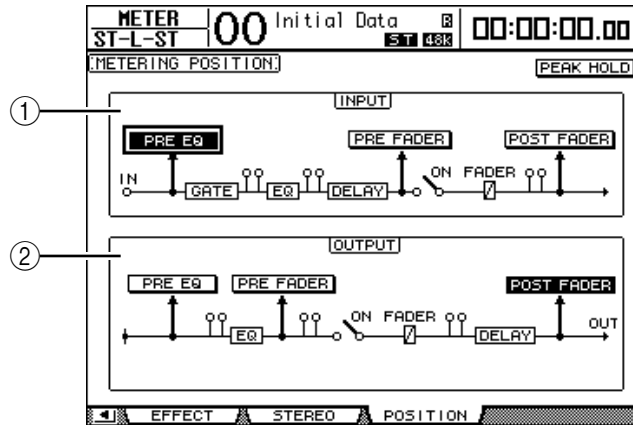

① **INPUT section**

This section enables you to select the metering position for Input Channel signals.

② **OUTPUT section**

This section enables you to select the metering position for Output Channel (Aux Out 1–8, Bus Out 1–8, Stereo Out) signals.

- 2 Move the cursor to the desired parameter button in the INPUT or OUTPUT section, then press [ENTER].

You can select one of the following three positions in each section.

- **PRE EQ** .....Immediately before EQ.
- **PRE FADER** .....Immediately before the fader.
- **POST FADER** .....Immediately after the fader.

**Tip:** If an optional MB1000 Peak Meter Bridge is installed, changes on this page will be reflected on the Input & Output Metering Position parameters on the Peak Meter Bridge.

- 3 Press the DISPLAY ACCESS [METER] button repeatedly until the page listed below that contains the desired channels appears.

- **CH1-32 page**
- **CH33-48 page**  
These pages display the Input Channel 1–32 levels and Input Channel 33–48 levels respectively.
- **CH1-48 page**  
This page displays the Input Channel 1–48 levels altogether.
- **Master page**  
This page displays the Output Channel (Aux Out 1–8, Bus Out 1–8, Stereo Out) levels altogether.
- **Effect page**  
This page displays the internal effects processor 1–4 input and output levels altogether.

- Stereo page

This page displays the Stereo Out or Control Room Monitor output level.

**Tip:** You can also select the CH1-32 page, the CH33-48 page, or the Master page using the LAYER buttons. In this case, if an optional MB1000 Peak Meter Bridge is installed, the Peak Meter Bridge displays the same signal meters in unison with the DM1000 meters.

4 If you selected the CH1-32 page, the CH33-48 page, or the Master page, use the MASTER MODE parameter to select one of the following three metering signal types:

- GATE GR..... The amount of gain reduction for the gate (except for the Master page)
- COMP GR..... The amount of gain reduction for the compressor
- LEVEL ..... Input Channel input level, or Output Channel output level

• CH1-32 page

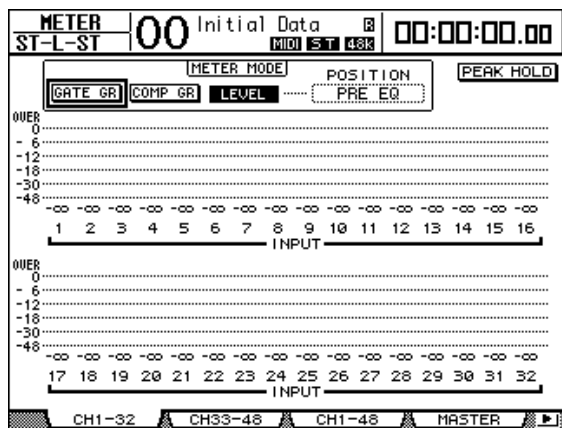

• CH33-48 page

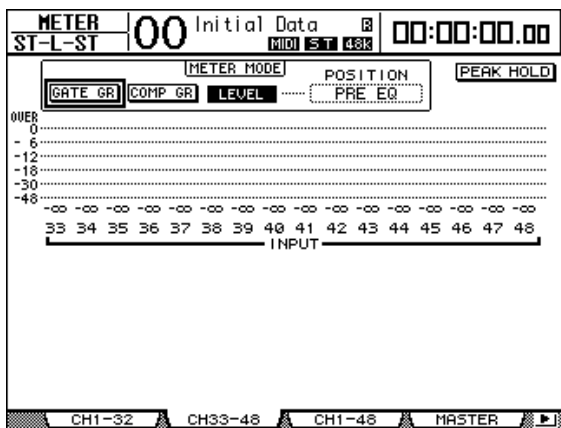

• CH1-48 page

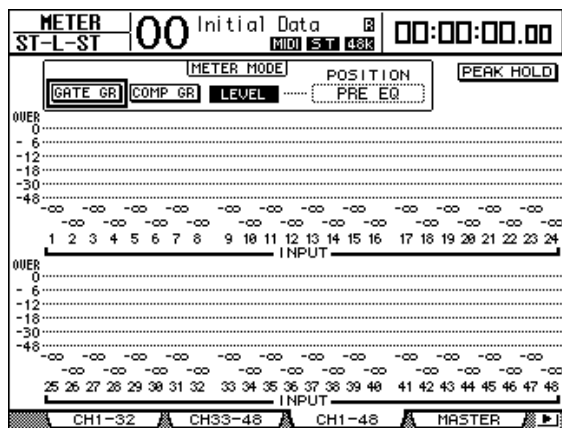

• Master page

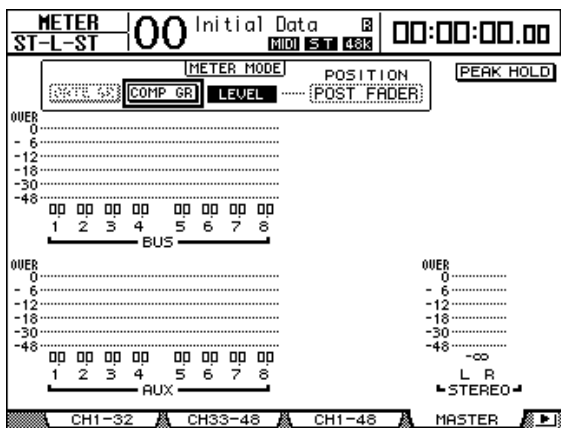

**Tip:** These pages also allow you to change the metering position using the POSITION parameter. This parameter setting operates in unison with the Meter | Position page setting.

- 5 If you selected the Stereo page, use the **METER MODE** parameter to select one of the following two metering signal types:
- **C-R**.....Control Room Monitor output signal
  - **STEREO**.....Stereo Out signal

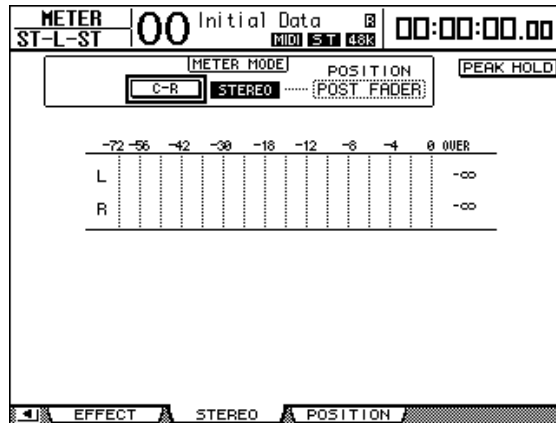

This parameter setting affects the meters on the Meter | Master page, the ST meter on the Stereo page, and the stereo meter on the right side of the display.

- 6 To activate the Peak Hold function, move the cursor to the **PEAK HOLD** button, then press **[ENTER]**.

The PEAK HOLD button turns on, and the peak level is held on the meters on the page and on the Peak Meter Bridge. To cancel the Peak Hold function, turn the PEAK HOLD button off. If an optional MB1000 Peak Meter Bridge is installed, its Peak Hold function switches in unison with the DM1000 meters.





# 4 Connections and Setup

This chapter explains how to connect and set up your DM1000.

## Connections

The following section explains three typical ways to connect the DM1000 to external equipment, although there are numerous others.

### ■ Configuring an analog 32-channel mixing system

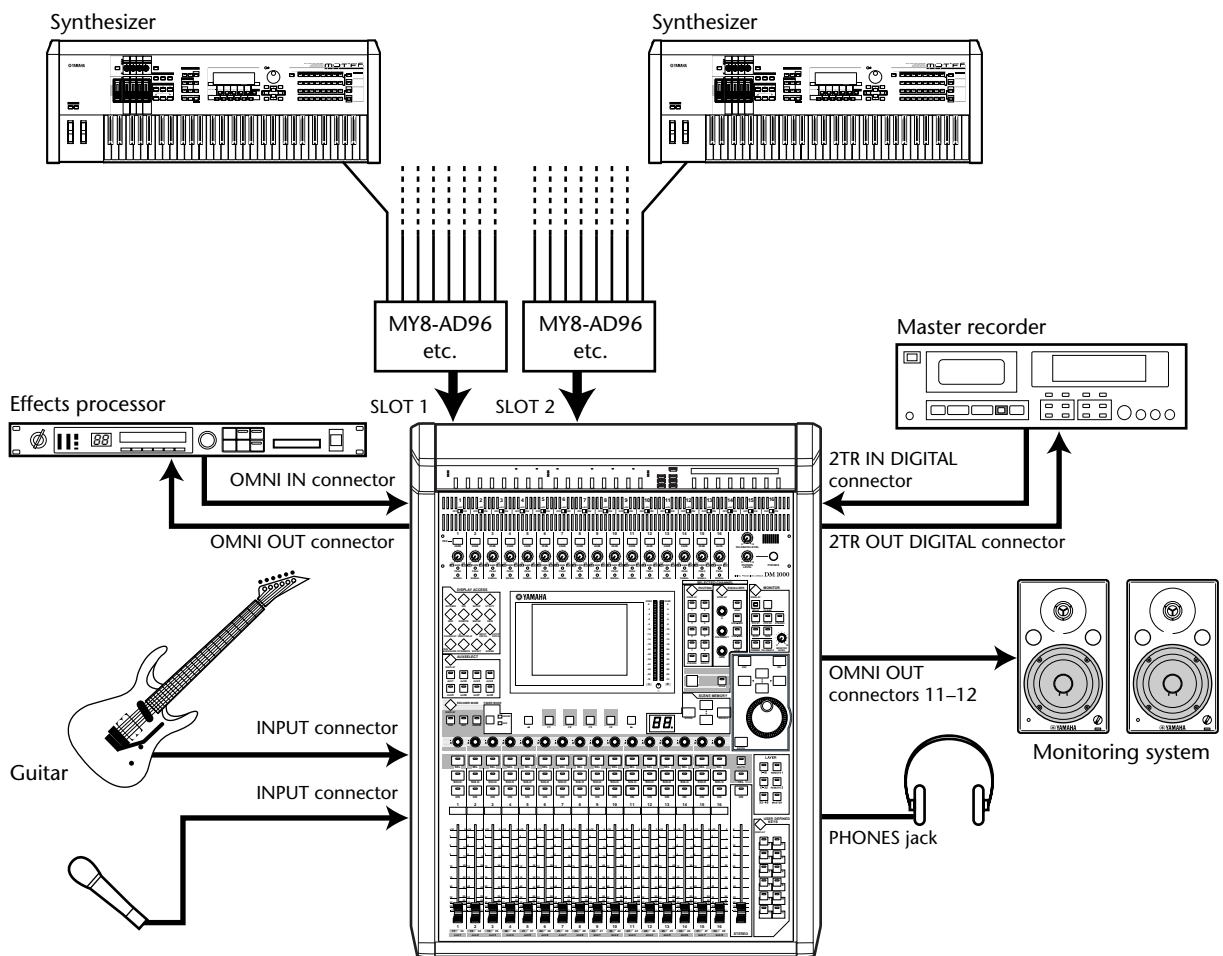

In this system, the DM1000, with optional AD cards (MY8-AD, MY8-AD96, etc.) installed in Slots 1 and 2, is used as a keyboard mixer or sound re-enforcement mixer. Up to 32 analog channels, including Inputs 1–16 and line inputs on the AD cards, are available for mixing.

**Tip:** You can adjust the gain of the AD card channels by setting the DIP switches on the cards. For more information, see your AD card documentation.

■ Configuring a recording system with a hard disk recorder

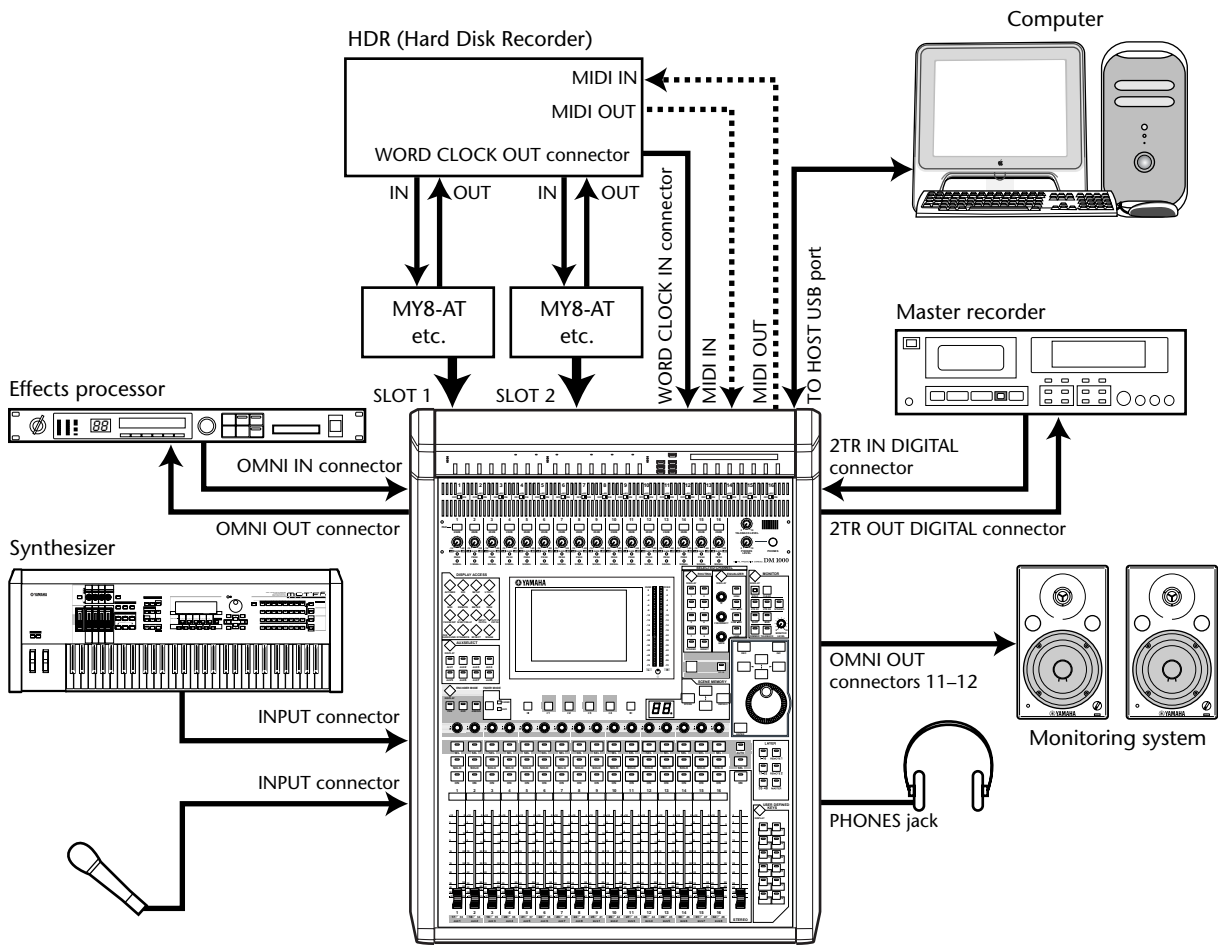

In this system, the DM1000, with optional I/O cards (MY8-AT, MY16-AT, MY8-TD, etc.) installed in Slots 1 and 2, is one component in a system that includes a digital MTR, such as a hard disk recorder. This system will support track recording, overdubbing, track bouncing, and mixdown. You can also control the hard disk recorder's transport section by sending MMC commands from the DM1000 to the recorder.

## ■ Configuring a recording system that uses a DAW (Digital Audio Workstation)

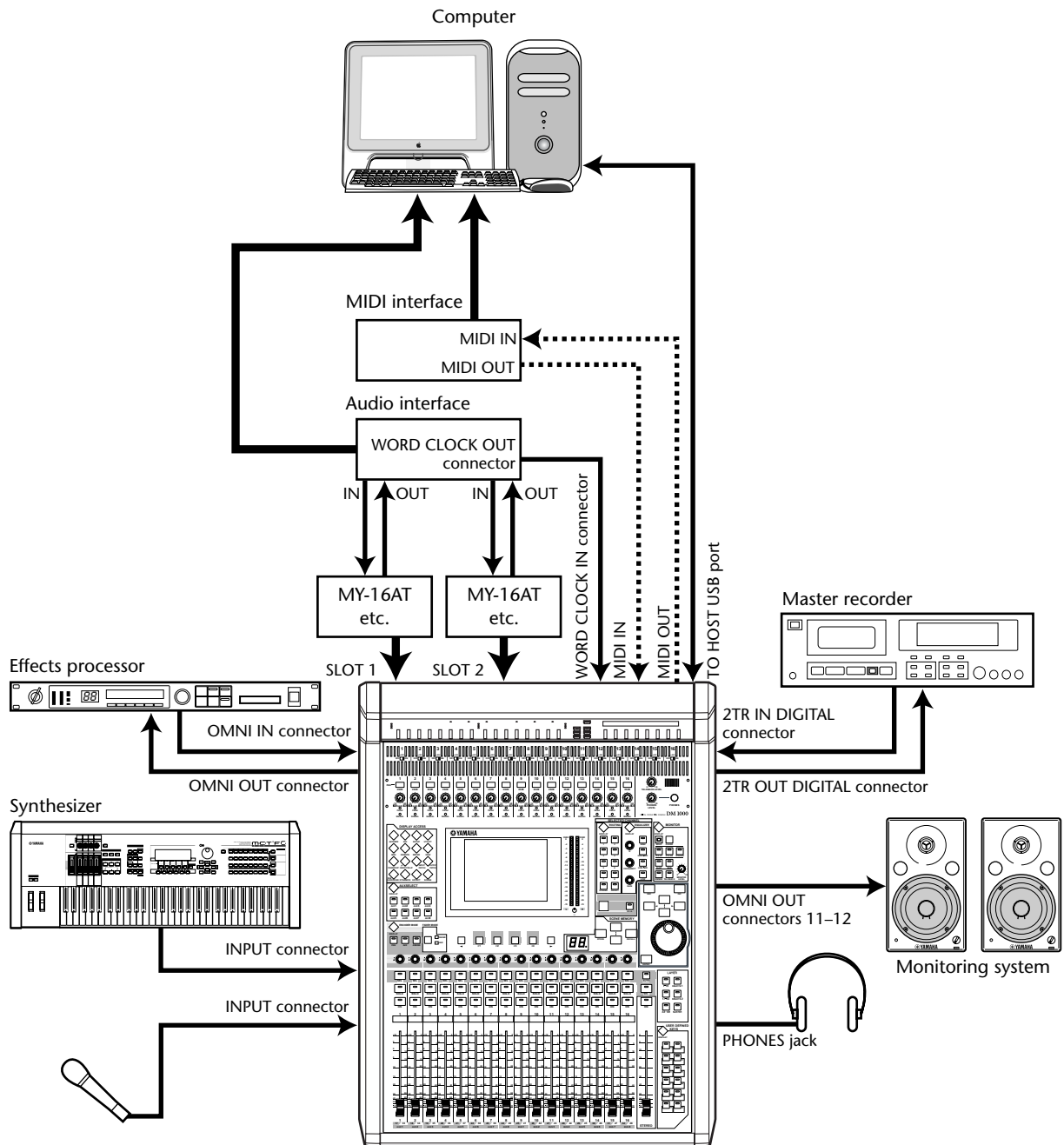

In this system, the DM1000, with optional I/O cards (MY8-AT, MY16-AT, MY8-AE, etc.) installed in Slots 1 and 2, is connected to a computer-based DAW (Digital Audio Workstation). The DM1000 can provide audio input and output for the DAW. If you connect the DM1000 and the computer via USB, the DM1000's Remote function enables you to control the DAW's locate and transport functions and change the parameters.

## Wordclock Connections and Settings

### About wordclock

Digital audio equipment must be synchronized when digital audio signals are transferred from one device to another. Even if both devices use identical sampling rates, digital signals may not transfer correctly, or audible noise or unwanted clicks may occur if the digital audio processing circuits inside each digital audio device are not synchronized with each other.

Wordclocks are signals that enable digital audio processing circuits to synchronize with each other. In a typical digital audio system, one device operates as the wordclock master, transmitting wordclock signals, and the other devices operate as wordclock slaves, synchronizing to the wordclock master.

If you are digitally connecting the DM1000 to other equipment, you must decide which device to use as the wordclock master and which devices to use as slaves, then set up all the devices accordingly. The DM1000 can be used as the wordclock master running at either 44.1 kHz, 48 kHz, 88.2 kHz, or 96 kHz, or slaved to an external wordclock source.

### Wordclock connections

To establish wordclock synchronization between the DM1000 and external devices, you can distribute wordclock signals independently via dedicated cables, or you can use clock information derived from digital audio connections.

The WORD CLOCK IN and OUT connectors transmit and receive wordclock signals independently on the DM1000. The following examples show two ways in which wordclock signals can be distributed and received via the WORD CLOCK IN and OUT connectors.

- **Daisy Chain Distribution**

In this example, the wordclock signal is distributed in a “daisy-chain” fashion, with each device feeding the wordclock signal from the wordclock out connector on to the wordclock in connector of the next device. This method of distribution is not recommended for larger systems.

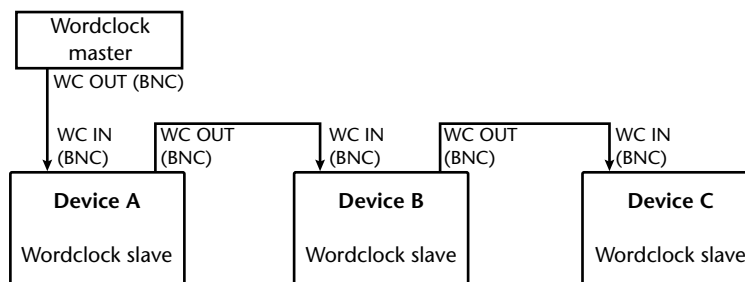

- **Star Distribution**

In this example, a dedicated wordclock distribution box (such as a Yamaha IFU4) is used to supply wordclock signals from the wordclock master to each wordclock slave individually.

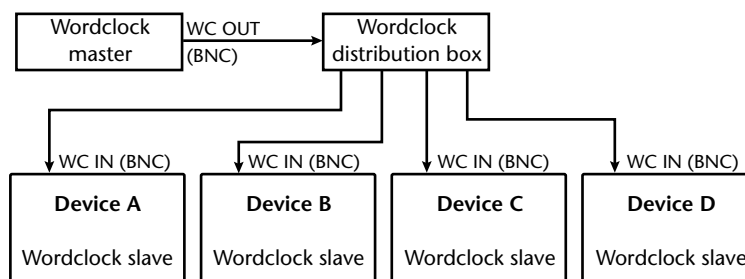

If the external devices do not have wordclock in and out connectors, you can use the clock information included in the digital audio signals. In this case, digital audio signals and wordclock signals are transferred via the 2TR OUT DIGITAL and 2TR IN DIGITAL jacks or via the digital I/O cards installed in the rear panel slots.

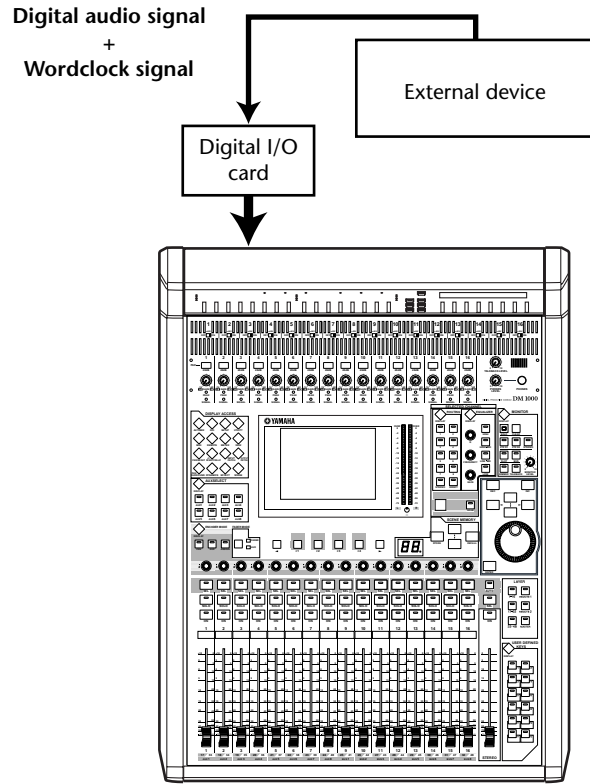

## Specifying the Wordclock Source

To digitally connect the DM1000 to external devices, you must specify the wordclock source for the system. Follow the steps below.

**Note:** When you change the wordclock settings on any device in your digital audio system, some devices may output noise due to being out of synchronization. Be sure to turn down your monitoring device before changing wordclock settings.

- 1 Press the DISPLAY ACCESS [DIO] button, then press the [F1] (WORD CLOCK) button.

The Word Clock page appears. On this page, you can view the current synchronization status of input signals at each slot and connector.

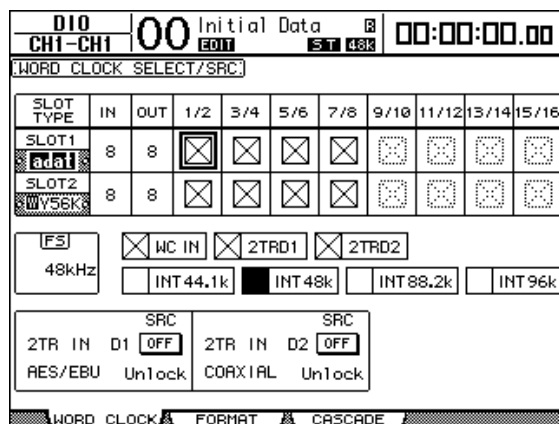

The source select button indicators are explained below:

- A usable wordclock signal is present at this input, and it is in sync with the current DM1000 internal clock.
- No wordclock signal is present at this input.
- A usable wordclock signal is present at this input, but it is out of sync with the current DM1000 internal clock.
- This input is the currently-selected wordclock source.
- This input was selected as the wordclock source, but no usable signal was received.
- This input cannot be selected as the wordclock source because (a) a wordclock signal cannot be sourced from this input on this type of I/O card, or (b) no I/O card is installed.

**Tip:**

- The FS box displays the sampling frequency at which the DM1000 is currently operating.
- The SLOT TYPE column displays the names of any installed I/O cards.
- The IN and OUT columns indicate the number of input and output channels available for each installed I/O card.

**2 Use the cursor buttons to move the cursor to a source, then press [ENTER].**

The following are possible wordclock sources:

- **SLOT1/SLOT2**..... These buttons select the inputs from the digital I/O cards installed in Slots 1 and 2 as the wordclock source. Inputs are selected in pairs (odd and even numbers in this order). The SLOT TYPE column displays the names of any installed I/O cards. The number of pairs depends on the type of I/O card installed.
- **WC IN**..... This button selects the wordclock signal input at the WORD CLOCK IN connector on the rear panel.
- **2TRD1** ..... This button selects the 2TR IN DIGITAL 1 input as the wordclock source.
- **2TRD2** ..... This button selects the 2TR IN DIGITAL 2 input as the wordclock source.
- **INT 44.1k, INT 48k, INT 88.2, INT 96k**..... These buttons select the internal clock generator as the wordclock source. The DM1000 will function as the wordclock master.

**Note:** To transfer data at higher sampling frequencies (88.2 kHz or 96 kHz) between the DM1000 and connected external devices, you need to set the data transfer format. See page 57 for more information.

**Tip:** If an external wordclock source fails, the DM1000 automatically switches to its internal clock generator at the closest frequency (INT 44.1k, INT 48k, INT 88.2k, INT 96k).

# Input and Output Patching

The DM1000 is designed to enable you to patch (assign) signals to Inputs and Outputs. This section explains how to view the signals patched to Inputs and Outputs and change the assignment.

**Tip:** If the data from a connected instrument fails to be input, or if you are unable to monitor an OMNI OUT, check the I/O patching, as explained below:

## Patching Input Channels

By default, the Input Channels are patched as follows:

- INPUT connectors 1–16 ..... Input Channels 1–16
- Channels 1–8 of Slot 1 ..... Input Channels 17–24
- Channels 1–8 of Slot 2 ..... Input Channels 25–32
- Outputs 1–2 of Internal Effects Processor 1–4 ..... Input Channels 33–40
- L&R of 2TR IN DIGITAL connectors 1–2 ..... Input Channels 41–44
- OMNI IN connectors 1–4 ..... Input Channels 45–48

Follow the steps below to view or change the patching.

- 1 Press the DISPLAY ACCESS [INPUT PATCH] button repeatedly until the following page appears.

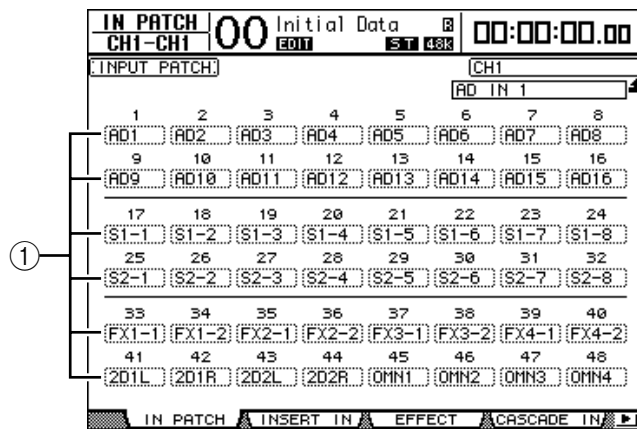

Inputs and Slot channels that are currently assigned to Input Channels are shown in the parameter boxes (①) beneath the channel numbers. The parameter indicators are explained below:

- – .....No assignment
- AD1–AD16.....INPUT connectors 1–16
- OMN1–OMN4 .....OMNI IN connectors 1–4
- S1-1–S116.....Channels 1–16 of Slot 1
- S2-1–S216.....Channels 1–16 of Slot 2
- FX1-1–FX1-8 .....Outputs 1–8 of Internal Effects Processor 1
- FX2-1–FX2-2 .....Outputs 1–2 of Internal Effects Processor 2
- FX3-1–FX3-2 .....Outputs 1–2 of Internal Effects Processor 3
- FX4-1–FX4-2 .....Outputs 1–2 of Internal Effects Processor 4
- 2D1L & 2D1R .....2TR DIGITAL IN 1 (L/R)

- 2D2L & 2D2R ..... 2TR DIGITAL IN 2 (L/R)
- BUS1–8..... Bus 1–8 Outputs
- AUX1–8..... Aux Send 1–8 Outputs

- 2 Use the cursor buttons to move the cursor to a patch parameter (①) for which you want to change the assignment, and rotate the Parameter wheel or press the [INC]/[DEC] buttons to modify the patching.
- 3 Press [ENTER] to confirm the change.

**Tip:**

- By default, you can also use the Encoders to select Input Channel sources. Rotate the Encoders to display the In Patch/In Patch page and select sources. Press the Encoder push switches to confirm the changes.
- To restore the default patching, recall Input Patch memory #00 (see page 168).

### Patching Omni Outs

By default, the Omni Outs are patched as follows:

- OMNI OUT connectors 1–8 .....Aux Sends 1–8
- OMNI OUT connectors 9–10 .....Stereo Bus L & R
- OMNI OUT connectors 11–12 .....Control Room Monitor L & R

Follow the steps below to view or change the patching.

- 1 Press the DISPLAY ACCESS [OUTPUT PATCH] button repeatedly until the following page appears.

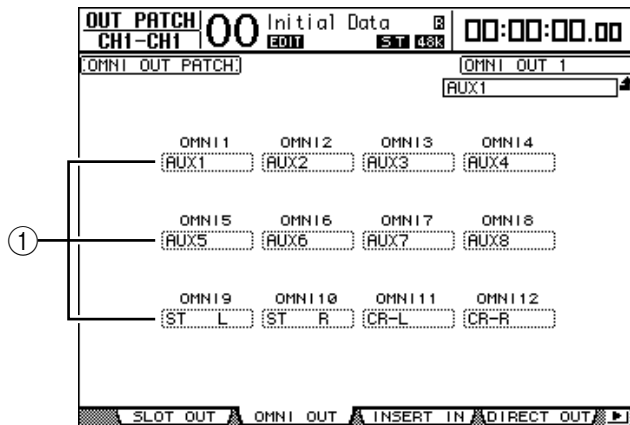

Signals that are currently assigned to the OMNI OUT connectors are shown in the parameter boxes (①) underneath the connector numbers. The parameter indicators are explained below:

- - .....No assignment
- BUS1–BUS8.....Bus 1–8 signals
- AUX1–AUX8 .....Aux Send 1–8 Signals
- ST L/R.....Stereo Bus signals
- INS CH1–INS CH48 .....Input Channels 1–48 Insert Outs
- INS BUS1–INS BUS8 .....Bus 1–8 Insert Outs
- INS AUX1–INS AUX8 .....Aux Send 1–8 Insert Outs
- INS ST-L/ST-R.....Stereo Bus Insert Outs



- **SURR XXX**  
 (“XXX” is a channel name)..... Surround Monitor Outs
  - **CR-L/CR-R**..... Control Room Monitor signals
  - **CAS BUS1–BUS8** ..... Bus 1–8 Cascade Outs
  - **CAS AUX1–AUX8**..... Aux Send 1–8 Cascade Outs
  - **CAS ST-L/ST-R**..... Stereo Bus Cascade Outs
  - **CASSOLOL/CASSOLOR** ..... Solo Bus Cascade Outs
  - **SOLO-L/SOLO-R**..... Solo Bus signals
  - **M.MX XXX**  
 (“XXX” is a channel name.) ..... Surround Monitor Outs
- 2 Use the cursor buttons to move the cursor to a patch parameter (①) you wish to change, and rotate the Parameter wheel or press the [INC]/[DEC] buttons to modify the patching.
  - 3 Press [ENTER] to confirm the change.

**Tip:** To restore the default patching, recall Output Patch memory #00 (see page 169).



# 5 Analog I/O & Digital I/O

This chapter describes the DM1000's analog and digital input/output connectors as well as the basic operations involving the digital I/Os.

## Analog Inputs & Outputs

### AD Input Section

The DM1000's rear panel features Input connectors 1–16, which enable you to connect microphone and line-level sources, and OMNI IN connectors, which enable you to connect line-level sources. Signals input at these connectors can be patched to Input Channels. (See page 105 for more information on patching Input Channels.)

- **INPUT connectors 1–16**

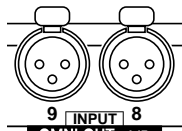

These balanced XLR-3-31-type connectors accept line-level and microphone signals. The nominal input range is –60 dB through +4 dB.

- **OMNI IN connectors 1–4**

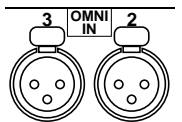

These balanced XLR-3-31-type connectors accept line-level signals. The nominal signal level is +4 dB.

- **Phantom Power**

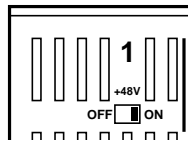

Inputs 1 through 16 feature switchable +48V phantom powering for use with condenser-type microphones and direct boxes. Individual +48V [ON/OFF] switches on each input turn phantom power on and off.

- **PAD switches**

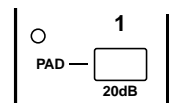

Inputs 1 through 16 feature pad switches, which attenuate input signals by 20 dB.

- **GAIN controls**

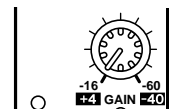

Inputs 1 through 16 feature rotary gain controls that adjust input sensitivity. Input sensitivity ranges from +4 dB to –40 dB when the Pad is on, and from –16 dB to –60 dB when the Pad is off.

- **PEAK & SIGNAL Indicators**

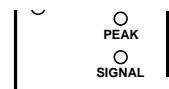

The SIGNAL indicator lights up when the input signal level is 20 dB below nominal. The PEAK indicator lights up when the input signal level is 3 dB below clipping.

## Omni Outs

- **OMNI OUT connectors 1–12**

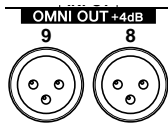

The DM1000 rear panel features OMNI OUT connectors 1–12 for connecting line-level sources, such as a monitoring system, master recorder, external effects processor. The OMNI OUT connectors use balanced XLR-3-32-type jacks, with a rated output level of +4 dB.

These outputs can be patched to Bus Outs and Input Channel Direct Outs. (See page 109 for more information on patching outputs to the Omni Outs.)

## Digital Inputs & Outputs

The DM1000 rear panel features digital input and output connectors that enable you to connect external digital devices. Any signal path can be patched to these digital inputs and outputs.

You can also add analog and digital I/Os by installing optional I/O cards in Slots 1 and 2.

### Digital I/O Connectors

- **2TR IN DIGITAL connector**

These connectors accept signals from a DAT or other 2-track digital recorder or consumer format digital audio device.

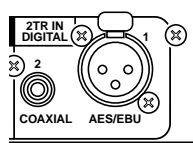

2TR IN DIGITAL 1 uses an XLR-3-31-type connector and accepts AES/EBU format digital audio.

2TR IN DIGITAL 2 is an RCA phono connector and accepts consumer format (IEC-60958) digital audio.

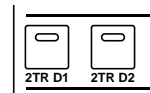

You can patch signals input at these connectors to any Input Channels (see page 110). You can monitor these inputs via the Control Room monitors by using the MONITOR [2TR D1] and [2TR D2] buttons.

- **2TR OUT DIGITAL connectors**

These connectors output signals to a DAT or other 2-track digital recorder or consumer format digital audio device.



2TR OUT DIGITAL 1 uses an XLR-3-32-type connector and outputs AES/EBU format digital audio.

2TR OUT DIGITAL 2 is an RCA phono connector and outputs consumer format (IEC-60958) digital audio.

You can patch outputs to Bus Outs and Input Channel Direct Outs (see page 110).

### SLOT 1–2

These slots allow you to install optional mini-YGDAI (Yamaha General Digital Audio Interface) I/O cards. These cards offer AD/DA conversion, and various analog I/O options and digital I/O interfaces in all the popular digital audio interconnect formats, including AES/EBU, ADAT, and Tascam. You can patch signals input at these card connectors to any Input Channels or Insert Ins (see page 106).

You can patch the card outputs to Bus Outs or Input Channel Direct Outs (see page 111).

The following mini-YGDAI I/O cards are currently available.

Card	Format	In	Out	Resolution/Sampling Rate	Connectors
MY8-AD	Analog in	8	—	20-bit, 44.1/48 kHz	Phone jack (balanced) x8
MY8-AD24 <sup>1</sup>				24-bit, 44.1/48 kHz	
MY4-AD		4	—	24-bit, 44.1/48 kHz	XLR-3-31 type (balanced) x4
MY8-AD96		8		24-bit, 44.1/48/88.2/96 kHz	25-pin D-sub
MY4-DA	Analog out	—	4	20-bit, 44.1/48 kHz	XLR-3-32 type (balanced) x4
MY8-DA96			8	24-bit, 44.1/48/88.2/96 kHz	
MY8-AE <sup>2</sup>	AES/EBU I/O	8	8	24-bit, 44.1/48 kHz	25-pin D-sub
MY8-AE96				24-bit, 44.1/48/88.2/96 kHz	
MY8-AE96S <sup>3</sup>				24-bit, 44.1/48/88.2/96 kHz	
MY8-AT <sup>2</sup>	ADAT I/O	16	16	24-bit, 44.1/48 kHz	Optical x2
MY16-AT					Optical x4
MY8-TD <sup>2</sup>	Tascam	8	8	24-bit, 44.1/48 kHz	25-pin D-sub BNC wordclock output
MY8-mLAN <sup>2</sup>	IEEE1394				6-pin 1394 connector x2

1. This card is a substitution for a 20-bit MY8-AD card.
2. These cards support 24-bit/96 kHz in Double Channel mode. (Separate 96 kHz wordclock required.)
3. This card is identical to the MY8-AE96, except that it features a sampling rate converter.

See the Yamaha Professional Audio Web site at the following URL for up-to-date news on I/O cards:

<<http://www.yamahaproaudio.com/>>.

## Converting Sampling Rates of Signals Received at 2TR Digital Inputs

The DM1000's 2TR Digital Inputs and an optional MY8-AE96S Digital I/O card feature sampling rate converters, so you can easily convert the sampling frequency of digital inputs to the current DM1000 sampling rate.

- 1 To convert the sampling rate of the signals input at the 2TR Digital Inputs, press the DISPLAY ACCESS [DIO] button, then press the [F1] button.

The DIO | Word Clock page appears. Use the following buttons to turn the sampling rate converter on and off.

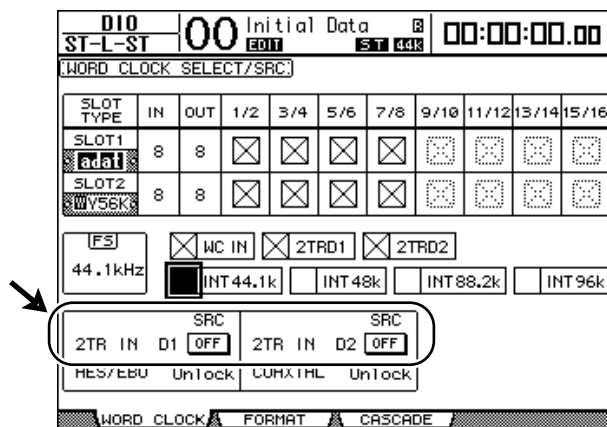

- 2TR IN D1 ..... This button turns on and off the sampling rate converter for 2TR IN DIGITAL 1.
- 2TR IN D2 ..... This button turns on and off the sampling rate converter for 2TR IN DIGITAL 2.

- 2 Use the cursor buttons to move the cursor to the 2TR IN D1 or 2TR IN D2 button, then press [ENTER].

The sampling rate converter for the selected 2TR Digital Input turns on or off. When on, the sampling rate of the received digital audio is converted to the DM1000's current sampling rate.

**Tip:**

- The FS box displays the sampling frequency at which the DM1000 is currently operating.
- The AES/EBU and COAXIAL parameter fields display the converted sampling rate. (If the current wordclock is not synched, they display "Unlock.")

- 3 To convert the sampling rate of the signals input at the installed I/O card inputs, press the DISPLAY ACCESS [DIO] button, then press the [F2] button.

The DIO | Format page appears.

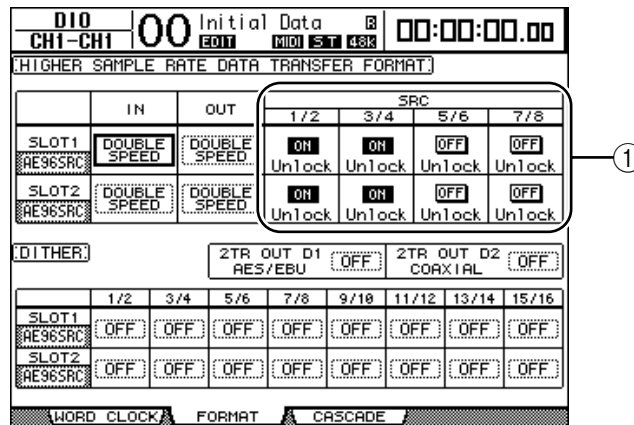

Use the buttons in the SRC sections (①) to turn the sampling rate converters on and off. You can turn the sampling rate converters of the digital I/O cards on or off in pairs (odd & even channels, in this order).

**Note:** The sampling rate converter is available only on the Yamaha MY8-AE96S Digital I/O card. If you have installed other types of I/O cards in the slots, or if no cards are installed in the DM1000, the buttons in the SRC sections are disabled.

- 4 Use the cursor buttons to move the cursor to any two-channel button in the SRC sections (①), then press [ENTER].

The sampling rate converter for the selected 2-channel input turns on or off. When on, the sampling rate of the received digital audio is converted to the DM1000's current sampling rate.

## Monitoring Digital Input Channel Status

You can view and monitor the Channel Status (sampling rate, emphasis, etc.) of digital audio signals connected to the 2TR Digital Inputs and Slot Inputs as follows.

### 1 Press the DISPLAY ACCESS [UTILITY] button, then press the [F2] button.

The Utility | CH Status page appears.

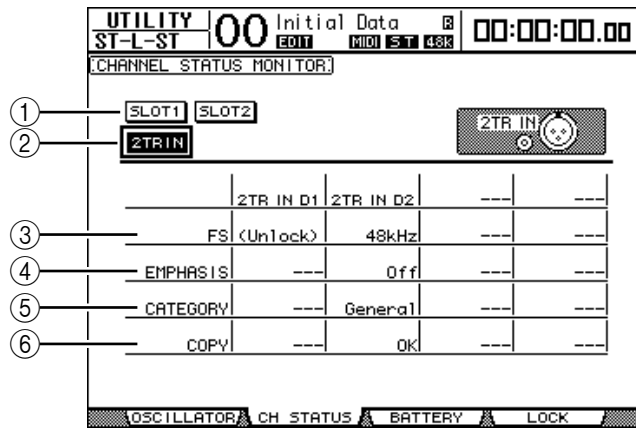

On this page, use the following buttons to select a slot or connector for which you want to view the channel status.

#### ① SLOT1, SLOT2

These buttons enable you to view the Channel Status of each two adjacent (odd and even, in this order) channel signals connected to the digital I/O cards installed in Slots 1 and 2.

#### ② 2TR IN

This button enables you to view the Channel Status of input signals connected to the 2TR Digital Inputs.

### 2 Move the cursor to the desired input or slot button, then press [ENTER].

Channel Status information for the selected input is displayed. Channel Status information includes the following items:

#### ③ FS

Indicates the sampling rate. If no signal is being input, or if the incoming wordclock is not synching to the internal clock, “Unlock” appears.

#### ④ EMPHASIS

Indicates the Emphasis on/off status.

#### ⑤ CATEGORY

Indicates the status of “Category Code Bit” included in the IEC958 Part 2 (S/PDIF-Consumer) format. This parameter can display the following values:

Parameter values	Description
General	Temporarily used.
Laser Optical	Laser optical device
D/D Conv	Digital - Digital converter and signal processing device
Magnetic	Magnetic tape device and magnetic disk device
D.Broadcast	Digital broadcast reception
Instruments	Musical instrument, microphone, and sources that generate string signals
A/D Conv	A/D converter (without copyright information)

Parameter values	Description
A/D Conv with(C)	A/D converter (with copyright information)
Solid Memory	Solid memory device
Experimental	Experimental device
Unknown	Unknown

**Note:** “AES/EBU” appears in the Category row when you are monitoring IEC958 Part 3 (AES/EBU-Professional) format signals (that do not include Category Code Bit).

⑥ COPY

Indicates the status of copy protection information included in the IEC958 Part2 (S/PDIF-Consumer) format signals. “OK” appears if copying is allowed. “Prohibit” appears if copy-protected.

## Dithering Digital Outputs

When digital audio is transferred to lower-resolution systems, truncated bits may generate unpleasant noise. To cancel the audible effect of this noise, a small complement of noise is intentionally added to the digital outputs. This process is called “dithering.”

On the DM1000, you can dither the 2TR Digital Outputs and Slot Outputs. For example, you can apply dithering to the DM1000 stereo mix data and record to a 16-bit DAT recorder.

**1 Press the DISPLAY ACCESS [DIO] button, then press the [F2] button.**

The DIO | Format page appears. The dithering settings are displayed on the bottom of the page.

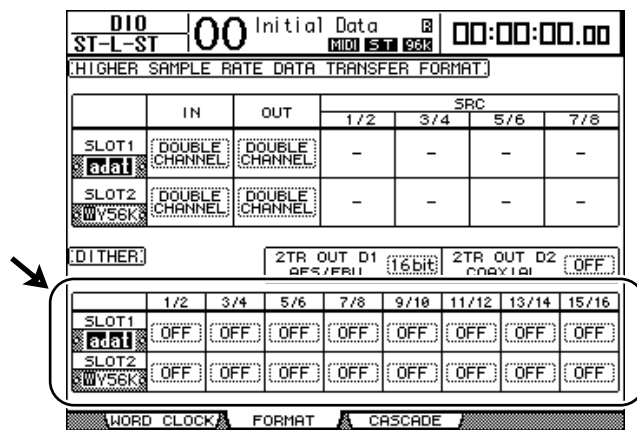

**2 Move the cursor to the output or channel to which you want to apply dithering, and rotate the Parameter wheel or press the [INC]/[DEC] buttons to select the value that matches the resolution of the receiving device.**

**Note:**

- You cannot apply dithering to outputs or channels that are set to “OFF”
- Dithering is effective only when the resolution of the receiving device is lower than that of the DM1000.

**Tip:** To copy the currently-selected setting to all channels, double-click the [ENTER] button. The copy confirmation window is displayed.



## Setting the Transfer Format for Higher Sampling Rates

To operate the DM1000 at higher sampling frequencies (88.2 kHz or 96 kHz) and transfer digital audio signals to and from connected external devices, you must set the data transfer format in accordance with the sampling frequencies supported by the external devices.

- 1 Press the DISPLAY ACCESS [DIO] button, then press the [F1] button.

The DIO | Word Clock page appears.

- 2 Select INT88.2k, INT96k, or an external device running at the higher sampling rates as the wordclock source.

- 3 Press the DISPLAY ACCESS [DIO] button, then press the [F2] button.

The DIO | Format page appears.

DIO		Initial Data		SRC			
ST-L-ST	00	MOD	INT	88k			
HIGHER SAMPLE RATE DATA TRANSFER FORMAT							
	IN	OUT	1/2	3/4	5/6	7/8	
SLOT1	DOUBLE CHANNEL	DOUBLE CHANNEL	-	-	-	-	
SLOT2	DOUBLE CHANNEL	DOUBLE CHANNEL	-	-	-	-	
DITHER		2TR OUT D1		2TR OUT D2			
		AES/EBU		COAXIAL			
	1/2	3/4	5/6	7/8	9/10	11/12	13/14
SLOT1	OFF	OFF	OFF	OFF	OFF	OFF	OFF
SLOT2	OFF	OFF	OFF	OFF	OFF	OFF	OFF
WORD CLOCK		FORMAT		CASCADE			

- 4 Use the cursor buttons to move the cursor to an IN/OUT parameter field (①), and rotate the Parameter wheel or press the [INC]/[DEC] buttons to set the data transfer format.

The IN/OUT parameters are used to set one of the following data transfer formats for each slot input and output.

- **DOUBLE CHANNEL**

In Double Channel mode, digital audio data is received and transmitted as mono signals at a sampling rate that is exactly half (44.1/48 kHz) the current higher sampling rate. Data is handled by two channels. This is useful when you wish to transfer data between the DM1000 running at a higher sampling rate and legacy 44.1/48 kHz digital MTRs or HDRs.

**Note:**

- Double Channel mode reduces the total number of inputs or outputs on the corresponding slot. The even-numbered channels are disabled.
- You cannot select this mode unless the DM1000 is operating at a higher sampling rate.

- **DOUBLE SPEED**

In Double Speed mode, digital audio data is received and transmitted at the current higher sampling rate (i.e., 88.2 kHz or 96 kHz). Select this mode if the devices that support the higher sampling rates transmit or receive data.

**Note:** This mode is available only on the slots in which optional Yamaha MY8-AE96 or MY8-AE96S Digital I/O cards are installed.

- **SINGLE**

In Single mode, digital audio data is received and transmitted at a sampling rate that is half (44.1/48 kHz) the current higher sampling rate of the DM1000. For example, this is useful when you wish to send 44.1 kHz digital signals from an external HDR to the DM1000 running at 88.2 kHz.

**Note:**

- *This mode is unavailable for slots in which optional Yamaha MY8-AE96 or MY8-AE96S Digital I/O cards are installed.*
- *You cannot select this mode unless the DM1000 is operating at a higher sampling rate.*

**Tip:**

- *The parameter fields display “–” if the corresponding slots contain no I/O cards or if AD/DA cards or other I/O cards that do not allow you to set the transfer format have been installed.*

# 6 Input Channels

This chapter describes how to adjust the DM1000's Input Channel parameters.

## About Input Channels

The input Channel section enables you to adjust the level and tone of the signals input to the DM1000 and route the signals to Bus 1–8, Stereo Bus, and Aux Out 1–8. The following diagram illustrates the Input Channel signal flow.

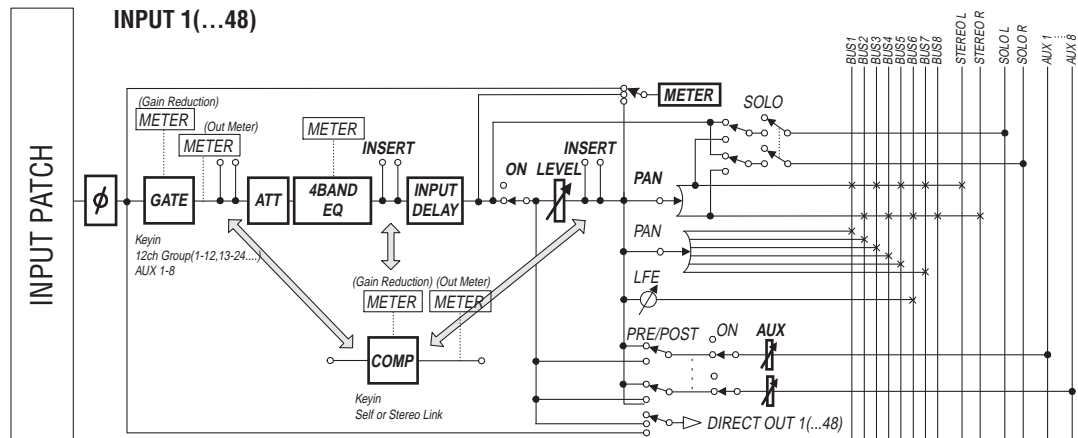

- **φ (Phase)**  
This section switches the phase of input signals.
- **GATE**  
This dynamics processor can be used as a gate or for ducking.
- **COMP (Compressor)**  
This dynamics processor can be used as compressor, expander or limiter. The compressor can be pre-EQ, pre-fader, or post-fader.
- **ATT (Attenuator)**  
This section enables you to attenuate or amplify the level of signals that will be input to the EQ. The attenuator enables you to prevent post-EQ signals from clipping and to correct signal levels that are too low.
- **4 BAND EQ (4-band equalizer)**  
This parametric EQ features four bands (high, high-mid, low-mid, and low).
- **INPUT DELAY (Input delay)**  
This section enables you to delay input signals. You can use this delay to fine-tune the timing between channels, or as a delay effect with feedback.
- **ON (On/Off)**  
This section enables you to turn the channel on or off. The channel is muted with the Off setting.
- **LEVEL**  
This section enables you to adjust the input level of the Input Channel signal.

- PAN**  
 This section enables you to adjust the pan setting of the signals routed from the Input Channels to the Stereo Bus. You can also apply the pan setting to a pair of Bus channels.  
 If the internal Surround Sound setting is activated, the Surround Pan settings for 3-1, 5.1, and 6.1 channels are available (see page 121).
- AUX (Aux Send level)**  
 This section enables you to adjust the level of signals routed to Aux Out 1–8. The signals can be routed to Aux Sends from either the pre-fader or post-fader position.
- INSERT**  
 This section enables you to patch input signals to external devices via the on-board I/O connectors or I/O cards, or insert the internal effect processors.
- METER**  
 This section enables you to switch the metering position of the signal levels that are displayed in the Meter page or on the optional MB1000 Meter Bridge. (See page 37 for more information on selecting the metering position.)

*Tip:* You can store these channel parameter settings in the Channel library. You can also store the Gate, Compressor, and EQ parameter settings to the corresponding libraries.

## Setting the Input Channels from the Display

To set the Input Channel parameters, you can either move the cursor to the desired parameter on the display and change the value, or operate the desired button or control on the top panel to directly change the setting.

This section explains how to set the parameters via the display.

### Switching the Signal Phase

To switch the phase of each Input Channel, press the [  $\phi$  /INSERT/DELAY ] button repeatedly until the following  $\phi$  /INS/DLY | Phase page appears.

Move the cursor to the NOR/REV button of the channel for which you want to change the phase, then press the [ENTER] or [INC]/[DEC] buttons to change the setting.

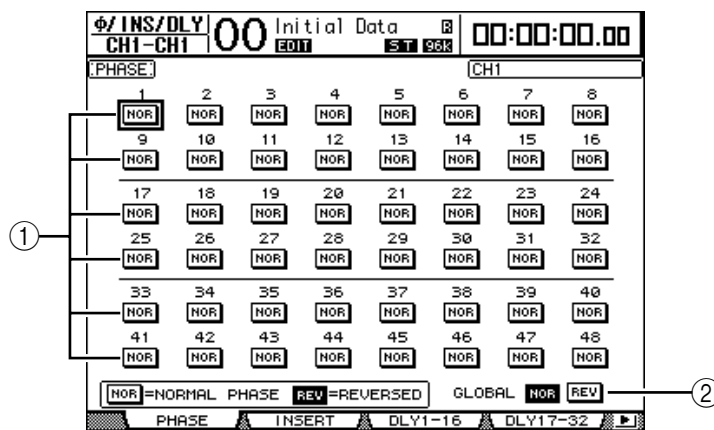

#### ① NOR/REV

These buttons switch the corresponding Input Channel phase. NOR buttons indicate normal phase, and REV buttons indicate reversed phase.

② GLOBAL

The GLOBAL NOR/REV buttons allow you to set the phase for all Input Channels simultaneously.

**Tip:**

- The name of the currently-selected channel is indicated in the upper-right corner of the screen.
- You can set the phase separately for each channel in a channel pair.

## Delaying Input Channels

To set the delay for each channel, press the [  $\phi$  /INSERT/DELAY ] button repeatedly until the page listed below that contains the desired channels appears.

- **DLY 1-16 page**  
This page enables you to set the Delay function for Input Channels 1–16.
- **DLY 17-32 page**  
This page enables you to set the Delay function for Input Channels 17–32.
- **DLY 33-48 page**  
This page enables you to set the Delay function for Input Channels 33–48.

The parameters on these three pages (and the procedure for setting them) are the same.

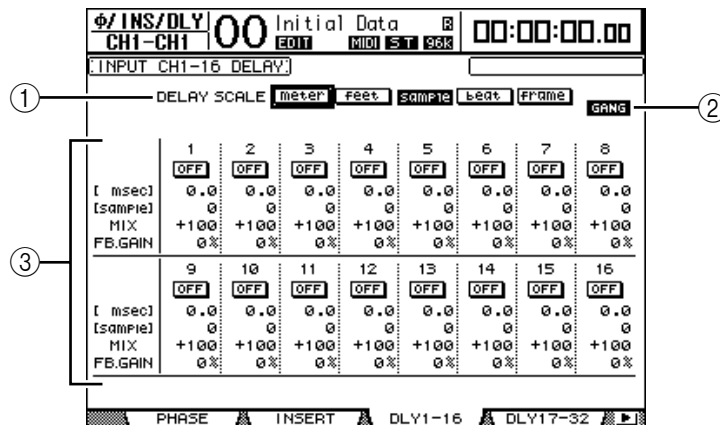

① DELAY SCALE

The following buttons determine the units of the delay value shown below the msec value.

- **meter**.....Units are set to meters.
- **feet**.....Units are set to feet.
- **sample** .....Units are set to samples.
- **beat**.....Units are set to beats.
- **frame**.....Units are set to timecode frames.

② GANG button

When this button is turned on (highlighted), the delay time for each channel in a channel pair can be set simultaneously. When this option is turned off, the delay time can be set for each channel in a channel pair individually.

③ **Channel section**

You can set individual delay parameters here. The delay parameters include the following items:

- **msec**..... This parameter sets the delay time in milliseconds.
- **meter/feet/sample/beat/frame** ..... The delay time can be set using units of meters, feet, samples, beats, or frames, which you select by using the DELAY SCALE buttons.
- **MIX**..... This parameter sets the mix balance of dry (Input Channel) and wet (delayed) signals.
- **FB.GAIN** ..... This parameter sets the amount of delay feedback.

**Tip:**

- The delay time range depends on the sampling rate at which the DM1000 is operating. (For example, at 44.1 kHz, the range is 0 through 984.1 msec.)
- If you select the DELAY SCALE meter or feet button, the distance value can be converted to the delay time based on sonic speeds (about 340 m/sec at 15 degrees Celsius). This option is useful if you wish to correct the timing difference between two sound sources that are far apart.
- If you select the DELAY SCALE beat button, a parameter box for setting a note that represents the beat and a parameter box for a tempo (BPM) setting appear below the DELAY SCALE parameter. Setting the note and BPM settings in these parameter boxes enables you to set a delay time that synchronizes to the song tempo.

## Gating Input Channels

To set the Input Channel gates, use the [SEL] buttons to select the desired Input Channel, then press the DISPLAY ACCESS [DYNAMICS] button, then the [F1] button. The Dynamics | Gate Edit page appears.

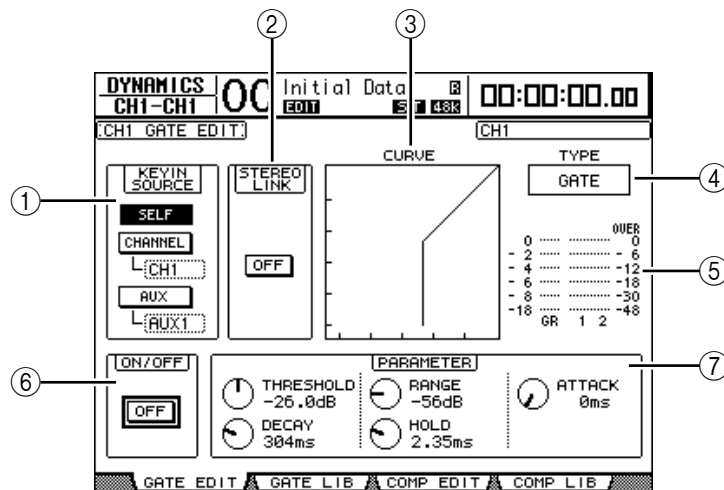

① **KEYIN SOURCE**

Select one of the following buttons to determine the trigger source for the currently-selected Input Channel's gate.

- **SELF**..... The selected channel's own input signal is the trigger source.
- **CHANNEL**..... Another Channel's input signal is the trigger source. Select the desired channel in the parameter box below the CHANNEL button.
- **AUX** ..... An Aux Send signal is the trigger source. Select the desired bus in the parameter box below the AUX button.

② **STEREO LINK**

This parameter's ON/OFF button enables you to pair gates for stereo operation even when the Input Channels are not paired.

③ **CURVE**

This area displays the current gate curve.

④ **TYPE**

This area displays the current gate type (GATE or DUCKING).

*Note:* You cannot change the gate type on this page. To change the gate type, recall a program that uses the desired gate type from the Gate library.

⑤ **Meters**

These meters indicate the levels of the post-gate signals and the amount of gain reduction.

⑥ **ON/OFF**

The ON/OFF button turns the currently-selected Input Channel's gate on or off.

⑦ **PARAMETER**

These controls enable you to set the gate parameters. (See page 320 for more information on the parameters.)

*Tip:* You can store the gate settings in the Gate library, which features preset programs that can be used for various applications (see page 174).

## Compressing Input Channels

To set the Input Channel compressors, use the [SEL] buttons to select the desired Input Channel, then press the DISPLAY ACCESS [DYNAMICS] button, then the [F3] button to display the Dynamics | Comp Edit page.

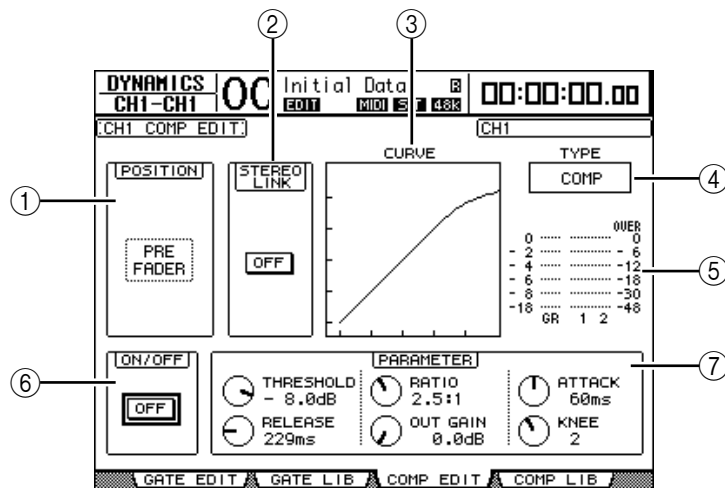

① **POSITION**

Use the Parameter wheel, or the [INC]/[DEC] buttons to select the position of the compressor within the channel from the following options:

- **PRE EQ** ..... Immediately before EQ (default)
- **PRE FADER** ..... Immediately before the fader
- **POST FADER** ..... Immediately after the fader

② **STEREO LINK**

This ON/OFF button enables you to pair compressors for stereo operation even when channels are not paired.

③ **CURVE**

This area displays the current compressor curve.

④ **TYPE**

This field indicates the compressor type used by the currently-selected channel's compressor (COMP/EXPAND/COMP (H)/COMP (S)).

**Note:** You cannot change the compressor type on this page. To change the compressor type, recall a program that uses the desired compressor type from the compressor library.

⑤ **Meters**

These meters indicate the levels of the post-compressor signals and the amount of gain reduction.

⑥ **ON/OFF**

The ON/OFF button turns the currently-selected Input Channel's compressor on or off.

⑦ **PARAMETER section**

These controls enable you to set the compressor parameters. (See page 320 for more information on the parameters of each compressor type.)

**Tip:** You can store the compressor settings in the Compressor library, which features preset programs that can be used for various applications (see page 175).

## Attenuating Input Channels

To set the attenuator for each channel, press the SELECTED CHANNEL EQUALIZER [DISPLAY] button repeatedly until the page listed below that contains the desired channels appears.

- **ATT 1-16 page**  
This page enables you to set the attenuators for Input Channels 1–16.
- **ATT 17-32 page**  
This page enables you to set the attenuators for Input Channels 17–32.
- **ATT 33-48 page**  
This page enables you to set the attenuators for Input Channels 33–48.

The parameters on these three pages (and the procedure for setting them) are the same.

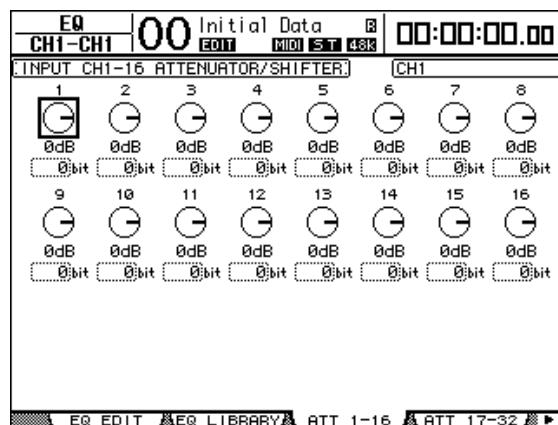

Move the cursor to the knob for the desired Input Channel, then rotate the Parameter wheel to set the amount of attenuation in the range of –96 dB to +12 dB. To reset the attenuation amount to 0 dB, move the cursor to the desired knob, then press the [ENTER] button.



You can also copy the currently-selected Input Channel attenuation setting to all Input Channels (including those not currently displayed on the screen). To do this, move the cursor to the source knob that you wish to copy, then double-click the [ENTER] button. The confirmation window appears. Select YES to execute the copy operation.

You can also set the amount of attenuation in bits. To set the amount in bits in the range of +2 bits to -24 bits, move the cursor to the desired bit shift parameter below the attenuator knob, then rotate the Parameter wheel. (This function is available only for the Input Channel attenuators. You cannot use this function for the Output Channel attenuators.) You can copy the currently-selected attenuation setting in bits to all Input Channels. To do this, move the cursor to the source bit shift parameter box that you wish to copy, then double-click the [ENTER] button. The confirmation window appears.

Select YES to execute the copy operation.

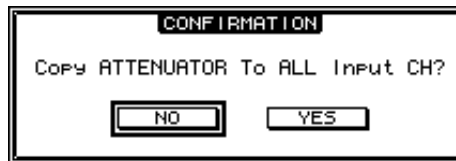

**Tip:**

- You can also display the desired page by pressing the EQUALIZER [DISPLAY] button once, then press the [SEL] button or move the fader of the corresponding channel.
- You can also set the attenuation amount (in dB) for the currently-selected channel on the EQ | EQ Edit page.

## EQ'ing Input Channels

The DM1000's Input Channels feature 4-band (LOW, LOW-MID, HIGH-MID, HIGH) parametric EQ. The LOW-MID and HIGH-MID bands are a peaking type of EQ. The LOW and HIGH bands can be set to shelving, peaking, or HPF and LPF respectively.

- 1 Press the [SEL] button or move the fader of the channel for which you wish to adjust EQ.
- 2 Press the SELECTED CHANNEL EQUALIZER [DISPLAY] button repeatedly to display the EQ | EQ Edit page.

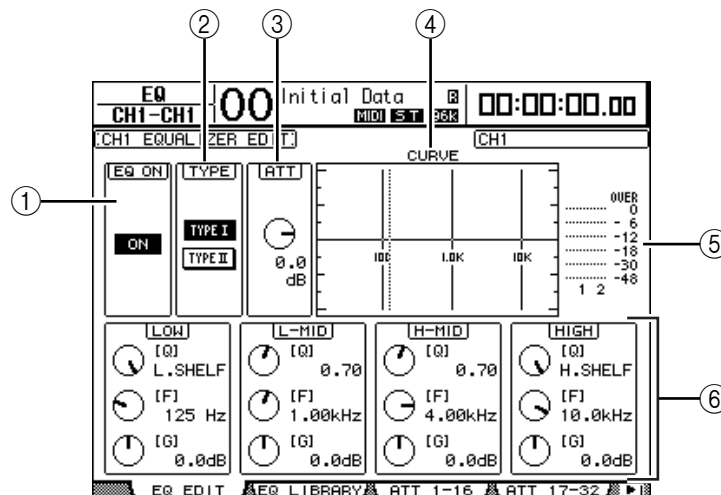

The parameters on this page are described below:

① **EQ ON**

The ON/OFF button turns the currently-selected Input Channel’s EQ on or off. You can press the [ENTER] button to turn the EQ on or off as long as the cursor is located on any parameter other than TYPE.

② **TYPE**

Selects the type of EQ. TYPE I is the EQ type used on legacy Yamaha 02R series digital mixing consoles. TYPE II is a newly developed algorithm.

③ **ATT**

Determines the amount of pre-EQ signal attenuation in dB. It is the same Attenuator parameter that appears on the EQ | ATT 1-16, ATT 17-32, and ATT 33-48 pages.

④ **CURVE**

This area displays the current EQ curve.

⑤ **Meters**

These meters indicate the post-EQ signal levels of the currently-selected Input Channel and its available pair partner.

⑥ **LOW, L-MID, H-MID, HIGH sections**

These sections contain the Q, Frequency (F), and Gain (G) parameters for the four bands. These parameter values range as follows:

Parameter	LOW	LOW-MID	HIGH-MID	HIGH
Q	HPF, 10.0 to 0.10 (41 steps), L.SHELF	10.0 to 0.10 (41 steps)		LPF, 10.0 to 0.10 (41 steps), H.SHELF
Frequency	21.2 Hz to 20.0 kHz (120 steps per 1/12 octave)			
Gain	-18.0 dB to +18.0 dB (0.1 dB steps) <sup>1</sup>			

1. The LOW and HIGH GAIN controls function as filter on/off controls when Q is set to HPF or LPF respectively.

**Tip:**

- The LOW-band EQ functions as a high-pass filter when the Q parameter in the LOW section is set to HPF. It functions as a shelving-type EQ when the Q parameter is set to L.SHELF.
- The HIGH-band EQ functions as a low-pass filter when the Q parameter in the HIGH section is set to LPF. It functions as a shelving-type EQ when the Q parameter is set to H.SHELF.

**3 Move the cursor to the desired parameter, then rotate the Parameter wheel to change the value.**

**Tip:**

- You can also press the buttons in the SELECTED CHANNEL section to select the desired band and use the rotary controls to directly edit the Q, F, and G parameters (see page 71).
- You can store the EQ settings in the EQ library, which features preset programs that can be used for various applications (see page 177).

## Panning Input Channels

Input Channels can be panned in the range of L63 through CENTER to R63. To pan each channel, press the [PAN/SURROUND] button repeatedly until one of the following pages that contains the desired channels appears.

- **Pan1-32 page**  
This page enables you to set the pan for Input Channels 1–32.
- **Pan33-48 page**  
This page enables you to set the pan for Input Channels 33–48.

The parameters on these two pages (and the procedure for setting them) are the same. Move the cursor to the desired Pan control, then rotate the Parameter wheel to set the value.

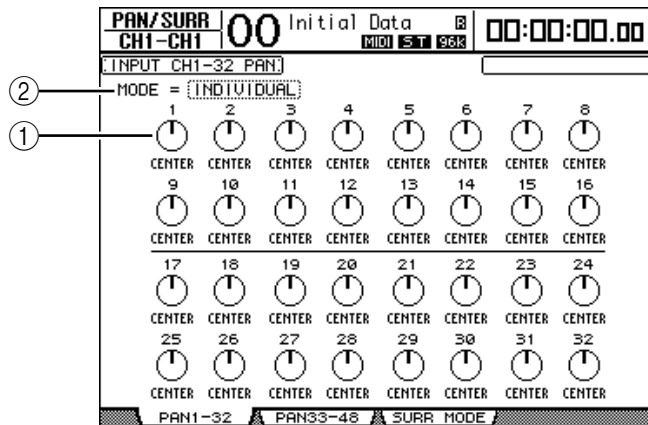

### ① Pan controls

These knobs adjust the channel pan settings.

Press the [ENTER] button to reset the currently-selected Pan control to center.

### ② MODE

The MODE parameter determines how paired Input Channels are panned. There are three Pan modes as follows:

- **INDIVIDUAL**.....In Individual mode, paired Input Channel pan controls operate independently.
- **GANG**.....In Gang mode, paired Input Channel pan controls operate in unison, maintaining the current pan range.
- **INV GANG**.....In Inverse Gang mode, paired Input Channel pan controls operate in unison but move in opposite directions.

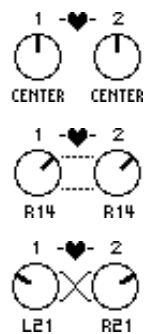

**Tip:**

- You can use the Encoders to change the Input Channel pan settings (see page 71). This is useful if you wish to change the pan settings quickly. You can also use the Joystick in the SELECTED CHANNEL section to change the pan settings, unless the DM1000 is in Surround mode.
- Surround Pan is available when the DM1000 is in Surround mode. Refer to Chapter 11 “Surround Functions” on page 121 for more information on Surround Pan.

## Routing Input Channels

You can route each Input Channel to the Stereo Bus, Bus 1–8, or its own Direct Out. With the default setting, signals are routed only to the Stereo Bus. However, you can patch signals to a single or multiple destinations, if necessary.

**1 Press the SELECTED CHANNEL ROUTING [DISPLAY] button repeatedly until the page listed below that contains the desired channels appears.**

- **CH1-16 page**  
This page enables you to change the routing for Input Channels 1–16.
- **CH17-32 page**  
This page enables you to change the routing for Input Channels 17–32.
- **CH33-48 page**  
This page enables you to change the routing for Input Channels 33–48.

*Tip:* You can also display the desired page by pressing the ROUTING [DISPLAY] button once, then press the [SEL] button or move the fader of the corresponding channel.

The parameters on these three pages (and the procedure for setting them) are the same.

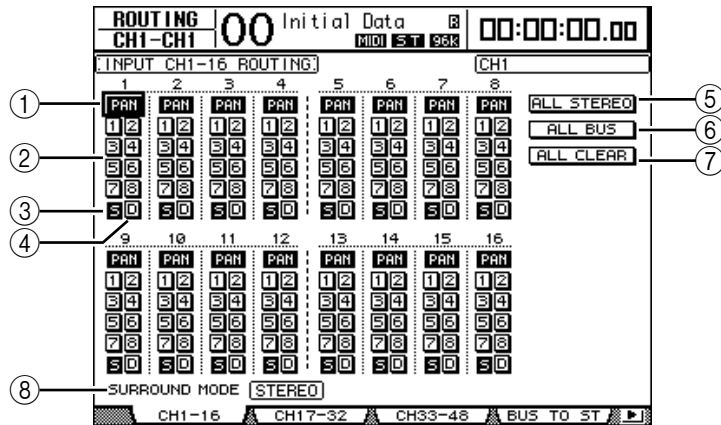

**① PAN buttons**

These buttons determine whether the Input Channel’s Pan setting is applied to the paired Bus outs (Follow Pan function).

**② Bus buttons 1–8**

These buttons route the currently-selected Input Channel to the Bus Outs. If the DM1000 is in Surround mode, the button indicators change as follows, depending on the selected Surround mode:

Bus buttons	1	2	3	4	5	6	7	8
Surround mode: 3-1	L	R	C	S	5	6	7	8
Surround mode: 5.1	L	R	Ls	Rs	C	E	7	8
Surround mode: 6.1	L	R	Ls	Rs	C	Bs	E	8

L=Left, R=Right, C=Center, S=Surround, Ls=Left Surround  
Rs=Right Surround, E=Low Frequency Effect, Bs=Back Surround

The above table shows the default assignment. The actual assignment may vary, depending on the settings on the Setup | Surround Bus Setup page.

**③ S button**

When this button is turned on, the currently-selected Input Channel is routed to the Stereo Bus.

④ **D button**

When this button is turned on, the currently-selected Input Channel is routed to its Direct Out. See page 111 for more information on the Direct Out.

⑤ **ALL STEREO button**

This button turns on the S button for all channels on the page.

⑥ **ALL BUS button**

This button turns on the Bus buttons 1–8 for all channels on the page.

⑦ **ALL CLEAR button**

This button clears all routing assignments on the page.

⑧ **SURROUND MODE**

This field displays the current Surround mode.

## Viewing Input Channel Settings

You can view and adjust parameter settings for the currently-selected Input Channel on the View | Parameter or Fader pages.

### ■ Viewing the Gate, Compressor, and EQ Settings

To display the View | Parameter page for a specific Input Channel, use the corresponding [SEL] button or fader to select the desired channel, then press the DISPLAY ACCESS [VIEW] button, then the [F1] button.

Move the cursor to a parameter you wish to change, and rotate the Parameter wheel or press the [INC]/[DEC] buttons or [ENTER] button to modify the setting.

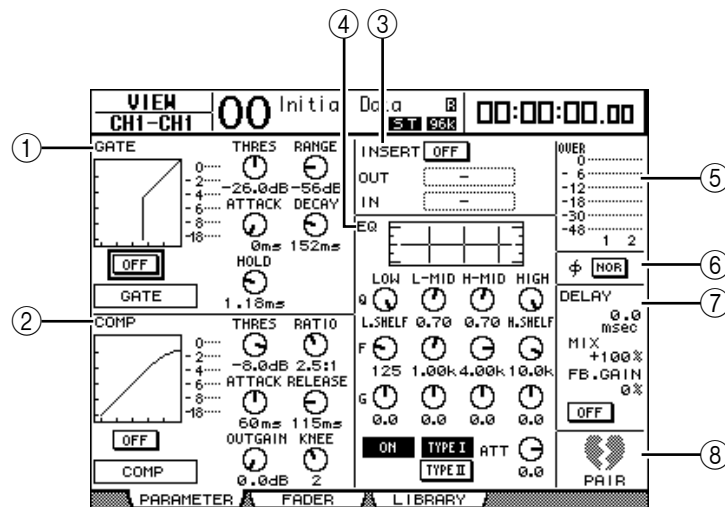
① **GATE section**

This section enables you to turn the gate-type dynamics processor on or off and set the parameters. (See page 62 for more information.)

② **COMP section**

This section enables you to turn the compressor-type dynamics processor on or off and set the parameters. (See page 63 for more information.)

③ **INSERT section**

This section enables you to turn the Insert on or off and patch the Insert In and Out. (See page 112 for more information.)

④ **EQ section**

This section enables you to set various EQ parameters. (See page 65 for more information.)

⑤ **Meters**

These meters indicate the signal levels of the currently-selected Input Channel and its available pair partner.

⑥ **∅ (Phase) section**

You can reverse the signal phase of the currently-selected Input Channel. (See page 60 for more information.)

⑦ **DELAY section**

This section enables you to set the currently-selected channel's Delay function. (See page 61 for more information.)

⑧ **PAIR section**

This section indicates whether or not channels are paired. The heart icon (♥) is in one piece when channels are paired. The heart icon is broken (♥) when channels are not paired. (See page 73 for more information.)

■ **Viewing the Pan, Fader, and Aux Send Level Settings**

To display the View | Fader page of a certain Input Channel, use the corresponding [SEL] button or fader to select the desired channel, then press the DISPLAY ACCESS [VIEW] button, then the [F2] button.

Move the cursor to a parameter you wish to change, then rotate the Parameter wheel or press the [INC]/[DEC] buttons to modify the setting.

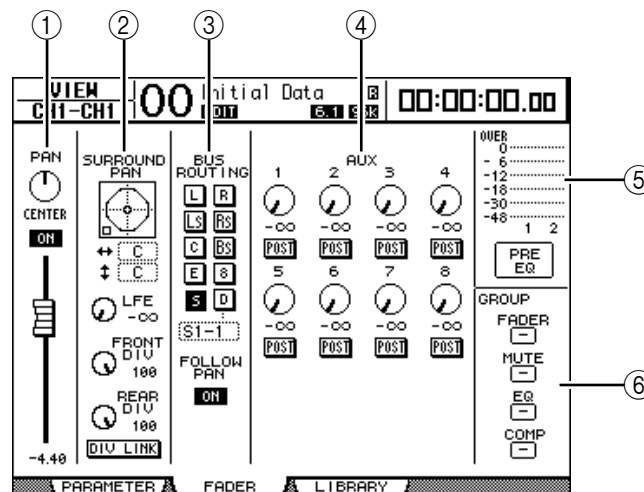

① **PAN/ON/Fader section**

- **PAN control**..... This control adjusts the currently-selected Input Channel's Pan parameter.  
Press the [ENTER] button to reset the Pan control to Center.
- **ON/OFF button** ..... This button turns on or off the currently-selected Input Channel.
- **Fader** ..... This parameter sets the fader position of the currently-selected Input Channel. The fader knob is highlighted when the fader is set to 0.0 dB.  
Press the [ENTER] button to reset the Fader to 0.0 dB.

② **SURROUND PAN section**

- **SURROUND PAN** ..... The Surround pan parameters for the currently-selected Input Channel are displayed only when a Surround mode is selected. See page 121 for more information on Surround pan.

### ③ BUS ROUTING/FOLLOW PAN section

- **BUS ROUTING** ..... This section enables you to select a destination Bus for the selected channel. When the D button is turned on, the channel signal is patched to the Direct Out selected in the parameter box below the button.
- **FOLLOW PAN** ..... This button determines whether the Input Channel's Pan setting is applied to the paired Bus Outs (Follow Pan function). When the button is turned off, the Follow Pan function is disabled and an identical signal is sent to the paired Bus Outs.

### ④ AUX section

- **AUX** ..... These controls set the currently-selected Input Channel's Aux Send 1–8 levels and positions. (See page 91 for more information on Aux Sends.)

### ⑤ Meter section

- **Meters** ..... These meters indicate the levels of the currently-selected Input Channel.
- **PRE EQ/PRE FADER/POST FADER** ..... The metering position is displayed below the meters.

### ⑥ GROUP section

- **FADER/MUTE/EQ/COMP** ..... These buttons indicate which Fader, Mute, EQ, or Comp group, if any, the currently-selected Input Channel is in. If the channel is in a group, the group number appears. If the channel is not in a group, “—” appears.

## Setting the Input Channels from the Control Surface

You can use the faders, Encoders, [SEL] buttons, and various buttons and controls in the SELECTED CHANNEL section on the top panel to directly control most parameters for Input Channels.

### Setting Input Channel Levels and Panning the Channels

- 1 Press the LAYER [1-16], [17-32], or [33-48] button to select a Layer.
- 2 Use the faders to set the Input Channel levels.
- 3 Press the ENCODER MODE [PAN] button, then rotate the corresponding Encoder to pan the desired Input Channel.

When you rotate the Encoder, the current pan setting display pops up.

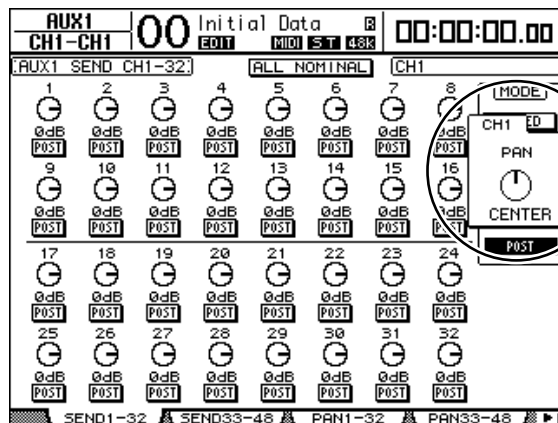

## Routing and EQ'ing Input Channels

- 1 Press the [SEL] button or move the fader for the channel you wish to control.
- 2 To route each Input Channel, use the following buttons in the **SELECTED CHANNEL** section:
  - **ROUTING [1]–[8] buttons** .....These buttons route the currently-selected Input Channel to a Bus.
  - **ROUTING [STEREO] button**.....When this button is turned on, Input Channel signals are routed to the Stereo Bus.
  - **ROUTING [DIRECT] button**.....When this button is turned on, the currently-selected Input Channel is routed to its Direct Out. (See page 111 for more information on Direct Out.)

The corresponding button indicator lights up.

- 3 To control EQ for the currently-selected channel, press one of the following buttons to select the band you wish to adjust:
  - **EQUALIZER [HIGH] button** .....HIGH band
  - **EQUALIZER [H-MID] button** .....HIGH-MID band
  - **EQUALIZER [L-MID] button** .....LOW-MID band
  - **EQUALIZER [LOW] button** .....LOW band
- 4 Use the **EQUALIZER [Q]**, **[FREQUENCY]**, and **[GAIN]** controls to adjust the Q, frequency, and gain of the band selected in Step 3.

See page 65 for more information on EQ.

**Tip:**

- Pressing and holding down the button selected in Step 3 resets the corresponding band parameter.
- Pressing the **SELECTED CHANNEL [HIGH]** and **[LOW]** buttons simultaneously resets all band parameters for the current EQ.



## Pairing Input Channels

On the DM1000, you can pair adjacent odd-even Input Channels or counterpart channels on Layer 1 and Layer 2 that share the same physical fader. Faders and most parameters of paired channels are linked for stereo operation. Paired channels' linked parameters and non-linked parameters (that are available for independent control) are listed below:

Linked parameters	Non-linked parameters
[SEL] buttons	Input patches
Faders	Insert patches
Channel on/off	Output patches
Insert on/off	Comp insert position
Solo on/off	Phase
Solo Safe	Delay on/off
Aux on/off	Delay time
Aux Send level	Delay feedback
Aux Sends as Pre or Post	Delay mix
Gate	Routing
Comp settings	Pan, Follow Pan
EQ settings	Surround pan
Fader group	Aux Send pan
Mute group	Balance
Fade time	Attenuators
Recall Safe	
Routing settings	

To pair channels, or to cancel channel pairs, you can use the [SEL] buttons on the top panel or access the Pair/Group pages.

### ■ Pairing Channels by Using the [SEL] Buttons

- 1 While pressing and holding down the [SEL] button for one of the channels you wish to pair, press the [SEL] button for the adjacent channel. (The paired channel numbers should be odd and even in this order).

**Note:** The settings of the first channel are copied to the second channel and the channels are paired if the Pair Confirmation check box on the Preference1 page is not checked (default). (If the selected channels have already been paired, this procedure will cancel the pair setting.)

The Channel Pairing window appears.

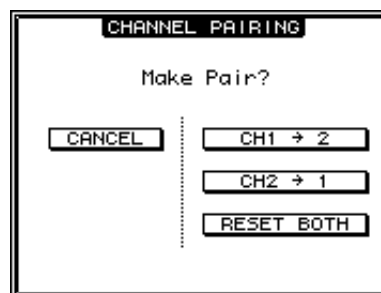

**Note:** You can pair only channels that are adjacent, odd-even (in this order) channels. Pressing the [SEL] button for a non-adjacent channel will be ignored. You cannot pair or cancel a pair of vertical partners.

**2 Move the cursor to the desired button in the Channel Pairing window, then press [ENTER].**

The following buttons are available in this window:

- **CANCEL**  
Cancels the operation.
- **CH x → y**  
Copies the odd channel parameter values to the even channel.
- **CH y → x**  
Copies the even channel parameter values to the odd channel.
- **RESET BOTH**  
Resets both channel parameters to the default settings (same as when Channel memory #01 is recalled).  
Move the cursor to the desired button, then press [ENTER] to confirm the pair.

*Tip: Pressing and holding down the first [SEL] button of the paired channels and pressing the second [SEL] button cancels the pair.*

**■ Pairing Input Channels Using the Display**

**1 Press the [PAIR/GROUP] button repeatedly until the Pair/Grup | Input page appears.**

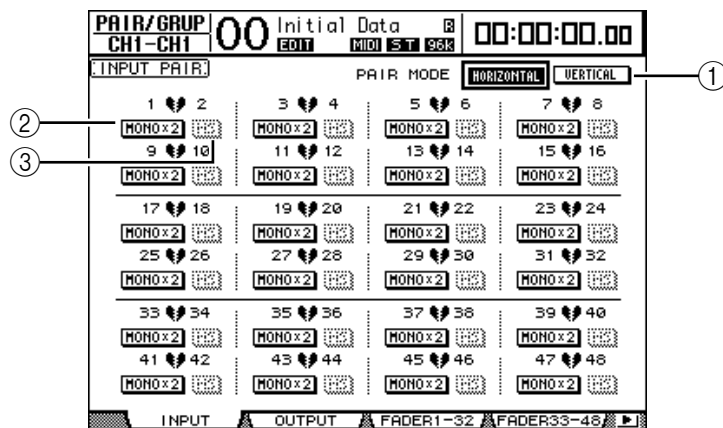

The parameters on this page are described below:

- ① **PAIR MODE**  
Determines how channels are paired.
- ② **STEREO/MONO x2 buttons**  
These buttons turn pairs on or off.
- ③ **MS buttons**  
These buttons are available when an MS microphone is connected. MS Decoding can be used to decode signals from MS microphones arranged as MS pairs. (See page 77 for more information on MS Decoding.)

**2 Move the cursor to the PAIR MODE parameter field (①), then select the HORIZONTAL or VERTICAL button.**

The function of each mode is described below:

- **HORIZONTAL**..... This button pairs adjacent odd-even channels (default).
- **VERTICAL**..... This button pairs counterpart channels on Layer 1 and Layer 2 that share the same physical fader (e.g., CH1 & CH17, CH16 & CH32, etc.). This mode is useful when you wish to use one fader to control both stereo channels.

When you switch the Pair Mode, the combinations of channel numbers displayed on the page also change.

**Note:**

- *When Pair mode is switched, only the channel numbers change. The mix parameters of the paired partners do not change.*
- *For example, if you change Pair mode from Horizontal to Vertical, the Input Channel “2” indication changes to Input Channel “17.” However, its parameters do not change. (If Channels 1 and 2 have been paired, switching the mode will pair Channels 1 and 17.)*

**3 Move the cursor to the desired channel’s MONOx2 button, then press [ENTER].**

The channels are paired.

**4 To cancel a pair, move the cursor to the desired channel’s STEREO button, then press [ENTER].**

**Tip:** *You can also pair or cancel a pair of Output Channels in the same way on the Pair/Group | Output page (see page 87).*

## Naming Input Channels

By default, Input Channels are named CH1, CH2, etc. You can change these names if necessary. For example, it may be helpful for mixdown if you name a particular Input Channel with the type of musical instrument connected to the corresponding input jack.

- 1 Press the **DISPLAY ACCESS [INPUT PATCH]** button repeatedly until the **In Patch | CH Name** page appears.

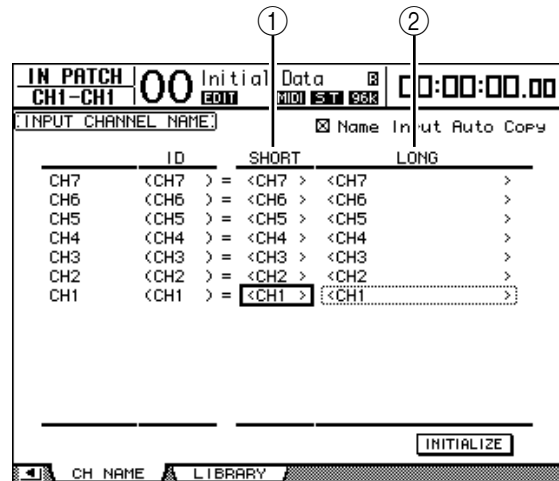

You can specify Short names in the center column (①) and Long (full) names in the right column (②).

- 2 Move the cursor to a name you wish to change, then press **[ENTER]**.

The Title Edit window appears, enabling you to enter a name.

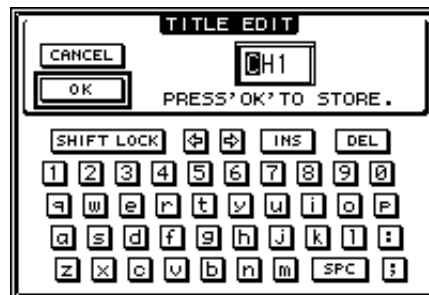

- 3 Edit the name, move the cursor to the **OK** button, then press **[ENTER]**.

The new name is now effective.

**Tip:** The edited name is stored in the Input Patch library.

## Using MS Stereo Microphone

The MS system is a type of stereo recording that uses two microphones; mono-directional M (Middle) and bi-directional S (Side) microphones. An M microphone picks up main signals, and an S microphone picks up directional signals. These two signals are decoded by calculating a sum (M plus S) and a difference (M minus S), and are recorded to L and R channels.

An MS microphone is usually a stereo microphone that has both M and S functions. Use an MS microphone in the following way:

- 1 Connect the R connector of an MS microphone to an odd channel input jack, and the L connector to an even channel input jack.**

Signals from the MS microphone are input from the L and R connectors. To use an MS microphone with the DM1000, connect the L connector to the input jack of an odd Input Channel, and connect the R connector to the input jack of the partner channel.

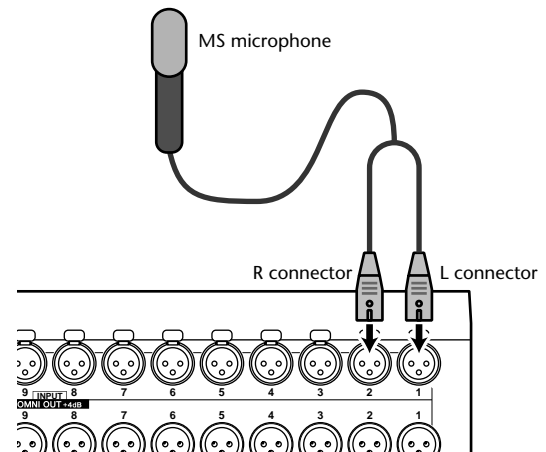

- 2 Press the [PAIR/GROUP] button repeatedly until the Pair/Group | Input page appears.**
- 3 Turn on the MS button for the channels to which the MS microphone is connected.**

The two channels are automatically paired and MS Decoding is turned on. With MS Decoding turned on, the faders and Encoders (Pan parameters) function as follows:

- **Odd-channel faders**.....M level (Controls the volume level.)
- **Odd-channel Encoders** .....ML/MR balance
- **Even-channel faders** .....S level (Controls the left and right directional spread.)
- **Even-channel Encoders** .....SL/SR balance

- 4 Use the faders and Encoders to adjust the MS microphone level and balance.**

When the signals are routed to paired Buses or the Stereo Bus, a sum of signals (ML plus SL) is sent to the odd-numbered Bus, and a difference of signals (ML minus SL) is sent to the even-numbered Bus.



# 7 Bus Outs

This chapter describes how to adjust the DM1000's Stereo Out and Bus Out parameters.

## About Stereo Out

The Stereo Out section receives Input Channel and Bus Out 1–8 signals, mixes them into two channels, processes them using on-board EQ, compressor, etc., then routes them to two channel output connectors. The following diagram illustrates the Stereo Out signal flow.

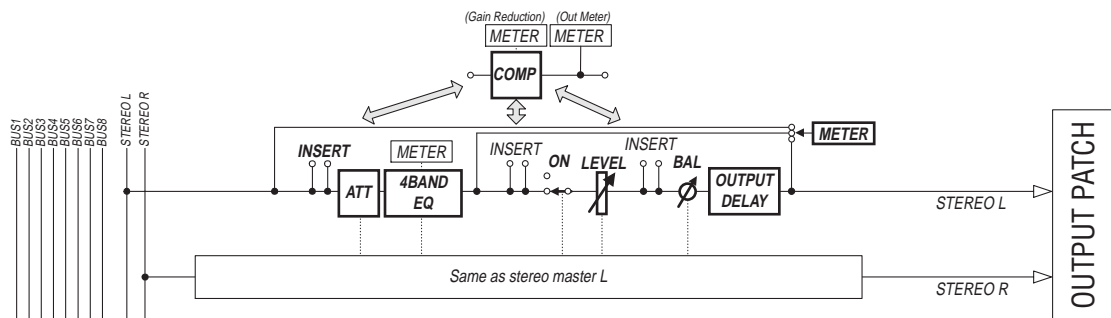

- **INSERT**  
This section enables you to route the Stereo Out signals to external devices via the on-board connectors or I/O cards, or insert internal effects processors.
- **ATT (Attenuator)**  
This section enables you to attenuate or amplify the level of signals to be input to the EQ. The attenuator prevents post-EQ signals from clipping or corrects signal levels that are too low.
- **4 BAND EQ (4-band equalizer)**  
This parametric EQ features four bands (HIGH, HIGH-MID, LOW-MID, and LOW).
- **COMP (Compressor)**  
This dynamics processor can be used as compressor, expander, or limiter. The processor can be located pre-EQ, pre-[STEREO] fader, or post-[STEREO] fader.
- **ON (On/Off)**  
This button turns the Stereo Out on or off.
- **LEVEL**  
The [STEREO] fader adjusts the Stereo Out output levels.
- **Balance**  
This section enables you to adjust the level balance between the L and R channels of the Stereo Out.
- **OUTPUT DELAY (Output delay)**  
This section delays the output signals. It is mainly used to fine-tune the signal timing.
- **METER**  
This section enables you to switch the metering position of signal levels that are displayed on the Meter page or by the stereo meter to the right of the screen. (See page 37 for more information on selecting the metering position.)

**Note:** By default, the Stereo Out signals are output to OMNI OUT 9–10. However, you can patch these signals to other output connectors or I/O cards using the Output Patch pages.

## Bus Out 1–8

The Bus Out 1–8 section mixes signals routed from Input Channels to the specified buses, processes them using on-board EQ, compressor, etc., then routes them to the specified output connectors or I/O cards.

The following diagram illustrates the Bus Out signal flow.

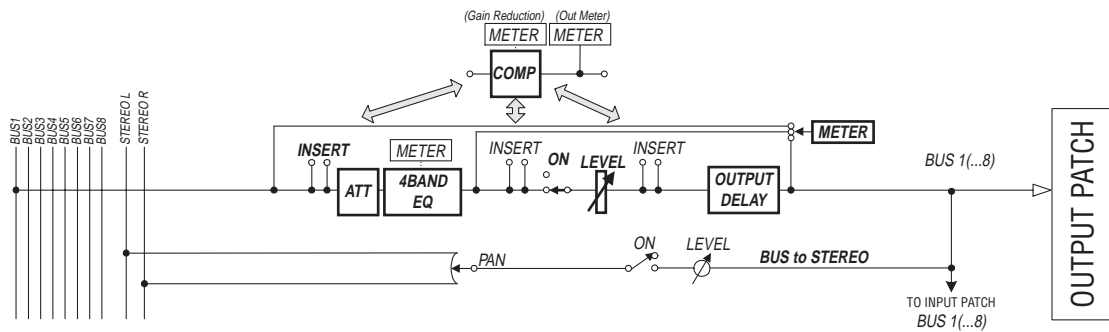

- INSERT
- ATT (Attenuator)
- 4 BAND EQ (4-band equalizer)
- COMP (Compressor)
- ON (On/Off)
- LEVEL
- OUTPUT DELAY (Output delay)
- METER

The parameters and sections listed above are identical to those for the Stereo Out. For more information, refer to the explanation the Stereo Out (see page 79).

- **Bus to Stereo**

Bus Out 1–8 signals are also routed to the Stereo Bus. In addition to the ON, LEVEL, and other parameters, you can also set the Send Level, On/Off, Pan, and other parameters.

**Tip:** You can also pair adjacent odd-even buses (in this order) for stereo operation (see page 87).

**Note:** By default, channels 1–8 and 9–16 of Slots 1 and 2 are patched to the Bus Out 1–8 outputs. However, you can change this patching on the Output Patch page.



## Setting the Stereo Out and Bus Out 1–8 from the Display

To set the Stereo Out and Bus Out 1–8 parameters, you can either move the cursor to the desired parameter on the display and change the value, or operate the desired button or control on the top panel.

This section explains how to set the parameters on the display.

**Tip:** Refer to Chapter 9 “Input & Output Patching” on page 105 for more information on how to set inserts.

### Attenuating the Stereo Out and Bus Out

To attenuate the Stereo Out and Bus Out signals, press the SELECTED CHANNEL EQUALIZER [DISPLAY] button repeatedly to display the EQ | Out Att page. On this page, you can attenuate the Bus Out 1–8, Aux Out 1–8, and Stereo Out signals.

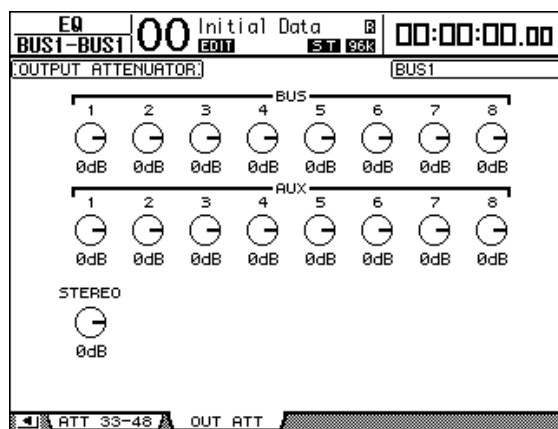

The parameters on this page (and the procedure for setting them) are the same as for Input Channels, except that this page does not include the bit shift parameters (see page 64).

### Delaying the Stereo Out and Bus Outs

To delay the Stereo Out and Bus Out 1–8 signals, press the [ $\phi$ /INSERT/DELAY] button repeatedly until the  $\phi$ /INS/DLY | Out Dly page appears.

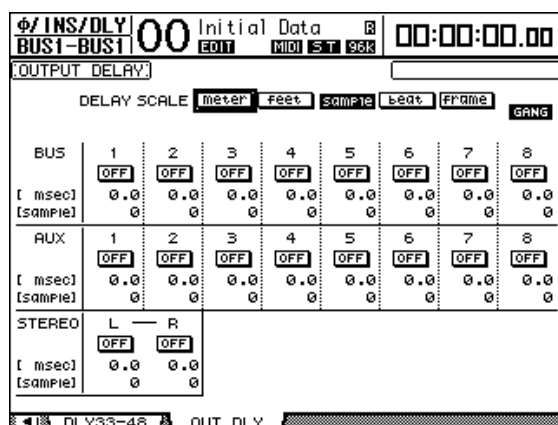

The parameters on this page (and the procedure for setting them) are the same as for Input Channels, except that this page does not include the MIX/FB.GAIN parameters (see page 61).

**Tip:** You can also display the Out Dly page by pressing the [ $\phi$ /INSERT/DELAY] button once, then press the [SEL] button or move the fader to select the Stereo Out or Bus Out 1–8.

## Compressing the Stereo Out and Bus Outs

To set the Stereo Out and Bus Out 1–8 compressors, press the [DYNAMICS] button, then the [F3] button to display the Dynamics | Comp Edit page, and use the [SEL] buttons or faders to select the Stereo Out or Bus Out 1–8.

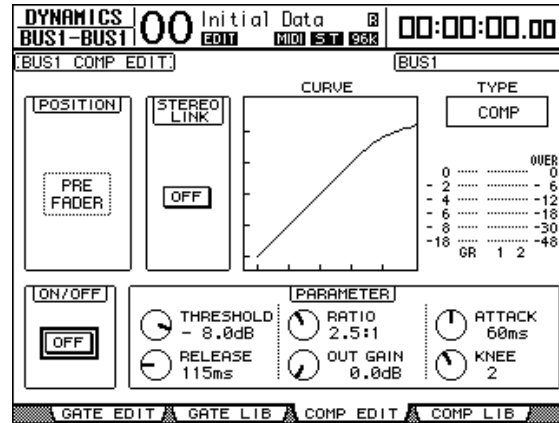

The parameters on this page (and the procedure for setting them) are the same as for Input Channels (see page 63).

## EQ'ing the Stereo Out and Bus Outs

To set the EQ for the Stereo Out and Bus Out 1–8 EQ, press the EQUALIZER [DISPLAY] button repeatedly to display the EQ | EQ Edit page, and use the [SEL] buttons or faders to select the Stereo Out or Bus Out 1–8.

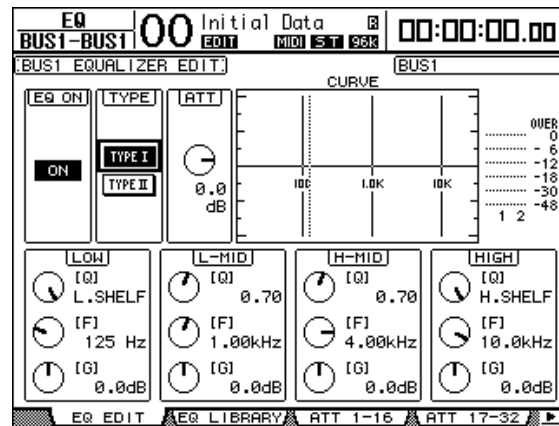

The parameters on this page (and the procedure for setting them) are the same as for Input Channels (see page 65).

## Routing Bus Out 1–8 Signals to the Stereo Bus

You can patch Bus Out 1–8 signals to Outputs and Slots 1/2, as well as to the Stereo Bus. You can adjust the level and pan settings of the signals routed to the Stereo Bus for each bus. This is convenient when you wish to use Bus Outs (1–8) as a Group Bus.

To patch the Bus Out 1–8 signals to the Stereo Bus, press the SELECTED CHANNEL ROUTING [DISPLAY] button repeatedly to display the Routing | Bus To St page.

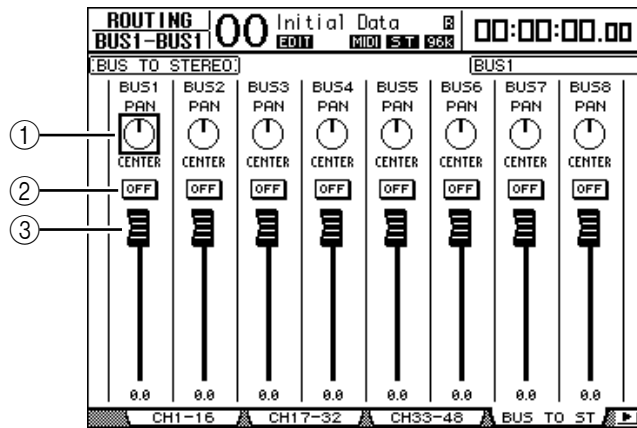

Move the cursor to the desired parameter you wish to change, then rotate the Parameter wheel or press the [INC]/[DEC] buttons to modify the setting.

### ① TO ST PAN

These controls pan the Bus Out 1–8 signals between the left and right Stereo Out buses.

### ② TO ST ON/OFF

These buttons turn on and off the Bus Out 1–8 to the Stereo Bus routing.

### ③ TO ST Faders

These faders set the Bus Out 1–8 to Stereo Bus levels.

#### **Note:**

- The settings on this page do not affect the Bus output levels and on/off settings on the Master layer.
- However, the Bus output levels and on/off settings on the Master layer affect the settings on this page.

## Viewing the Stereo Out and Bus Out Settings

You can view and adjust parameter settings for the currently-selected Stereo Out or Bus Out on the View | Parameter and Fader pages.

### ■ Viewing the Compressor and EQ Settings

To display the View | Parameter page, use the corresponding [SEL] button or fader to select the desired bus, then press the DISPLAY ACCESS [VIEW] button, then the [F1] button.

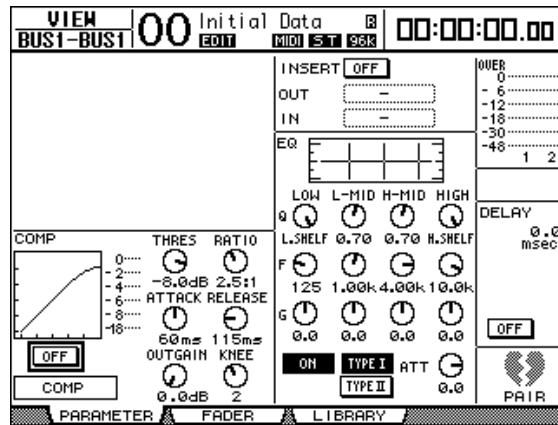

The parameters on this page (and the procedure for setting them) are the same as for Input Channels, except for the following items:

- The Stereo Out and Bus Out 1–8 Parameter pages do not contain the Gate and Phase parameters.
- The Stereo Out Parameter page does not contain the Pair parameter.

### ■ Viewing Faders and Other Parameters

To display the View | Fader page, use the corresponding [SEL] button or fader to select the desired bus, then press the DISPLAY ACCESS [VIEW] button, then the [F2] button.

The Fader page layouts for Stereo Out and Bus Out 1–8 are slightly different.

- Stereo Out Fader page

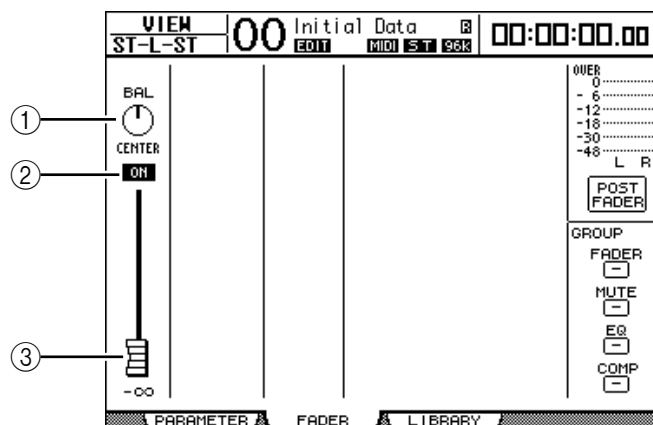

- ① **BAL**  
This control adjusts the level balance between the L and R channels of the Stereo Out.
- ② **ON/OFF**  
This button turns the Stereo Out on or off, and links with the [ON] button in the STEREO section.

### ③ Fader

This fader adjusts the Stereo Out output levels, and links with the [STEREO] fader. The fader knob is highlighted when the fader is set to 0.0 dB.

- **Bus Out (1–8) Fader page**

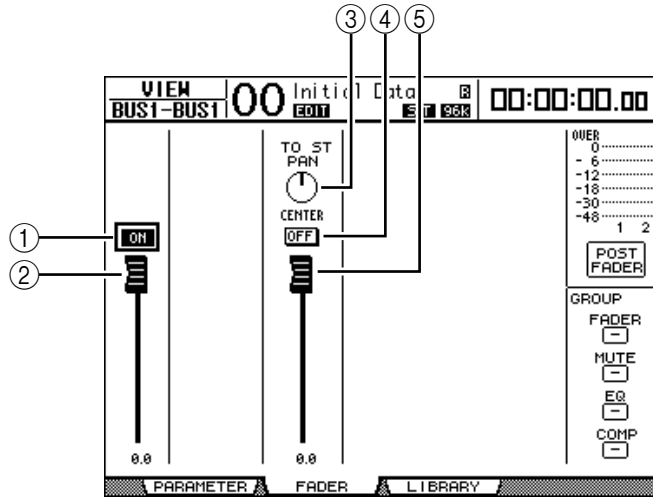

#### ① ON/OFF

This button turns the currently-selected Bus Out (1–8) on or off, and links with the [ON] (9–16) button in the Master layer.

#### ② Fader

This fader sets the currently-selected Bus Out (1–8) level, and links with the fader (9–16) in the Master layer. The fader knob is highlighted when the fader is set to 0.0 dB.

#### ③ TO ST PAN

This control sets the Bus Out to Stereo Out Pan position for the currently-selected Bus Out (1–8).

#### ④ TO ST ON/OFF

This button turns on or off the Bus Out to Stereo Out signal for the currently-selected Bus Out (1–8).

#### ⑤ TO ST Fader

This fader sets the Bus Out to Stereo Out signal level for the currently-selected Bus Out (1–8).

**Tip:** The TO ST PAN, ON/OFF, and TO ST Fader parameters also appear on the Routing | Bus to St page.

## Setting the Stereo Out and Bus Out 1–8 from the Control Surface

You can use the faders, Encoders, [SEL] buttons, and various buttons and controls in the SELECTED CHANNEL section on the top panel to directly control certain parameters for the Stereo Out and Bus Out 1–8.

### Setting the Levels

Move the [STEREO] fader to adjust the Stereo Out levels. Press the [ON] button in the STEREO section to turn the Stereo Out on or off.

To set Bus Out 1–8 levels, press the [MASTER] button in the LAYER section to select the Master layer, then move faders 9–16. At this time, you can turn Bus Out 1–8 on or off using the [ON] 9–16 buttons.

### EQ'ing the Stereo Out and Bus Outs

- 1 Press the [SEL] button or move the fader of the bus to which you want to apply EQ.
- 2 To control the EQ of the currently-selected bus, select the desired band to adjust by pressing one of the following buttons:
  - EQUALIZER [HIGH] button .....HIGH band
  - EQUALIZER [H-MID] button .....HIGH-MID band
  - EQUALIZER [L-MID] button .....LOW-MID band
  - EQUALIZER [LOW] button .....LOW band
- 3 Use the EQUALIZER [Q], [FREQUENCY], and [GAIN] controls to adjust the Q, frequency, and gain of the band selected in Step 2.

See page 65 for more information on EQ.

## Pairing Buses or Aux Sends

You can pair adjacent odd-even (in this order) buses or Aux Sends for stereo operation. Paired bus and Aux Send linked parameters and non-linked parameters (that are available for independent controls) are listed below:

Linked parameters	Non-linked parameters
[SEL] buttons	Output Patching
Fader	Insert Patching
Channel on/off	Delay on/off
Insert on/off	Delay time
Solo on/off	Bus to Stereo Pan (*)
Comp settings	
Comp insert position	
EQ settings	
Fader group	
Mute group	
Fade time	
Recall safe	
Attenuators	
Bus to Stereo on/off (*)	
Bus to Stereo fader (*)	

Parameters marked with an asterisk (\*) are available only for Bus Outs.

- 1 Press the DISPLAY ACCESS [PAIR/GROUP] button repeatedly until the Pair/Grup | Output page appears.

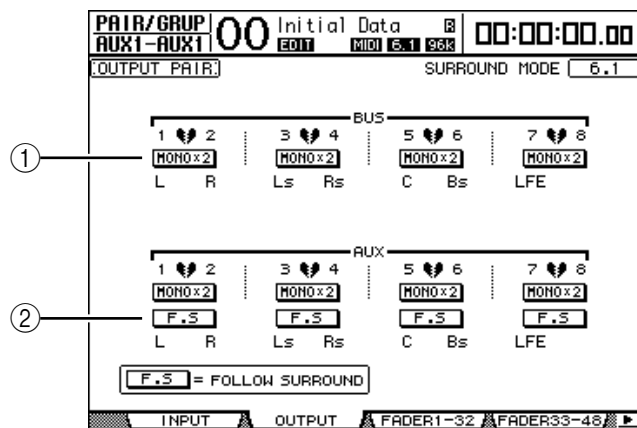

The parameters on this page are described below.

- ① **STEREO/MONOx2**

These buttons turn Bus or Aux Send pairs on or off.

- ② **F.S**

This button determines whether Aux Sends follow the Input Channel Surround Pan when the DM1000 is in a Surround mode. When this button is turned on, Aux Sends follow the Input Channel Surround Pan. This is useful for feeding Surround signals to external Surround effects processors.

- 2 Move the cursor to the MONOx2 button for the desired Bus or Aux Send, then press [ENTER].

The buses or Aux Sends are paired.

- 3 To cancel a pair, move the cursor to the STEREO button for the desired Bus or Aux Send, then press [ENTER].

## Attenuating Output Signals

To attenuate the DM1000's output signals, display the EQ | Out Att page and adjust the Stereo Out and Bus Out 1–8 attenuators individually.

If necessary, you can also select Output and I/O card channels and specify the amount of attenuation. This technique is convenient when you want to attenuate output signals quickly, regardless of the source signal patching.

- 1 Press the DISPLAY ACCESS [SETUP] button repeatedly until the Setup | Output Att page appears.

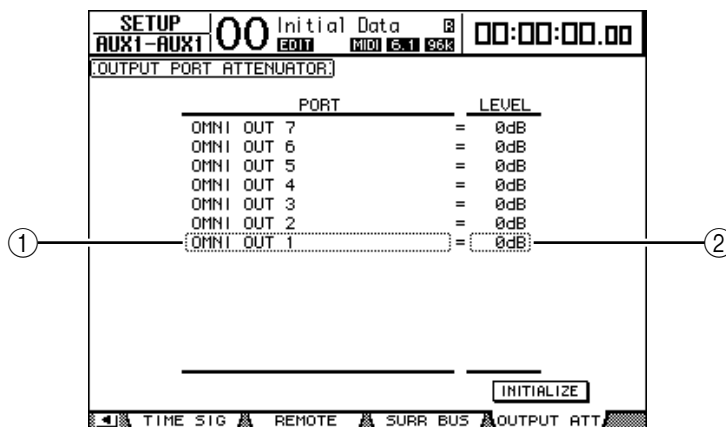

- 2 Move the cursor in the left column (①), then scroll the list up or down using the Parameter wheel to select the desired output or slot channel for which you want to adjust attenuation.

The following outputs and slot channels can be selected:

- OMNI OUT 1–12.....OMNI OUT connectors 1–12
- SLOT 1-1 through 1-16.....Channels 1–16 of Slot 1
- SLOT 2-1 through 2-16.....Channels 1–16 of Slot 2

- 3 Move the cursor to the parameter value in the right column (②), then rotate the Parameter wheel or press the [INC]/[DEC] buttons to set the amount of attenuation.

The amount of attenuation can be set from 0 dB to –9 dB.

**Tip:** To reset the attenuation amount of all Output Channels to 0 dB, move the cursor to the INITIALIZE button, then press [ENTER].



## Naming the Stereo Out and Bus Outs

You can change the default Bus names (BUS1, AUX4, STEREO, etc.). It may be convenient to name the buses “Monitor Out” or “Effect Send,” for example, so that you can easily identify the signal type.

- 1 Press the DISPLAY ACCESS [OUTPUT PATCH] button repeatedly until the Out Patch | CH Name page appears.

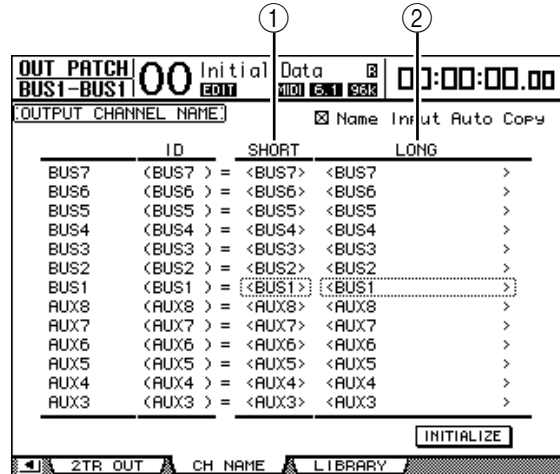

You can specify Short names in the center column (①) and Long (full) names in the right column (②).

- 2 Move the cursor to a name you wish to change, then press [ENTER].

The Title Edit window appears, which enables you to edit the name.

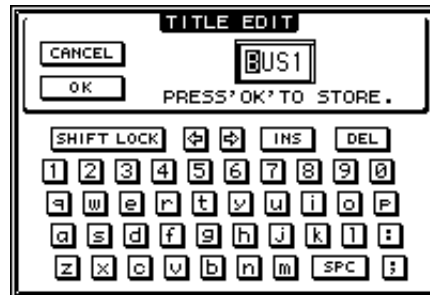

- 3 Edit the name, move the cursor to the OK button, then press [ENTER].

The new name is now effective.

**Tip:** The edited name is stored in the Output Patch library.



## 8 Aux Sends

This chapter describes how to control Aux Out 1–8.

### Aux Out 1–8

The Aux Out 1–8 section mixes signals routed from the Input Channels to the corresponding Aux Sends, processes them using on-board EQ, compressor, etc., then routes them to the specified internal effects processors, output connectors or I/O card connectors.

The DM1000 features eight Aux Sends, which can be used to send signals to the internal and external effects processors and monitors.

The following diagram illustrates the Aux Out 1–8 signal flow.

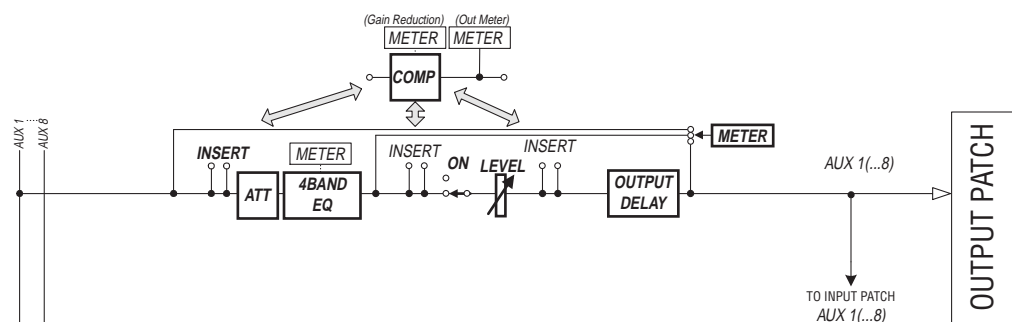

- INSERT
- ATT (Attenuator)
- 4 BAND EQ (4-band equalizer)
- COMP (Compressor)
- ON (On/Off)
- LEVEL
- OUTPUT DELAY (Output delay)
- METER

These parameters are the same as the Stereo Out and Bus Out 1–8 (see page 79).

**Tip:** You can also pair adjacent odd-even Aux Sends (in this order) for stereo Aux operation.

**Note:** With the default setting, Aux Out 1–8 are patched to OMNI OUT connectors 1–8 and Aux Out 1–4 are patched to internal effects processors 1–4. However, you can change this patching on the Out Patch page.

## Setting Aux Out 1–8 from the Control Surface

You can use the faders, Encoders, [SEL] buttons, and various buttons and controls in the SELECTED CHANNEL section on the top panel to directly control certain parameters for Aux Out 1–8.

### Setting Levels

To set Aux Out 1–8 levels, press the [MASTER] button in the LAYER section to select the Master layer, then move faders 1–8. At this time, you can turn Aux Out 1–8 on or off using the corresponding [ON] 1–8 buttons.

### EQ settings

To control Aux Out 1–8 EQ parameters, select the desired Aux Out (1–8) using the corresponding [SEL] button or fader, then use the buttons and controls in the SELECTED CHANNEL section. The parameters on this page (and the procedure for setting them) are the same as for Input Channels (see page 72).

## Setting Aux Out 1–8 from the Display

To set Aux Out 1–8 parameters, you can either move the cursor to the desired parameter on the screen and change the value, or operate the desired button or control on the top panel. This section explains how to set the parameters on the screen.

**Tip:** Refer to Chapter 9 “Input & Output Patching” on page 105 for more information on how to set inserts.

### Attenuating Aux Outs

To attenuate Aux Out 1–8 signals, press the SELECTED CHANNEL EQUALIZER [DISPLAY] button repeatedly to display the EQ | Out Att page.

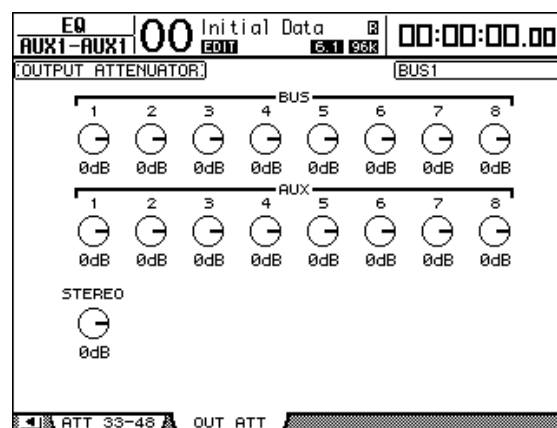

The parameters on this page (and the procedure for setting them) are the same as for Input Channels, except that this page does not include the bit shift parameters (see page 64).

## Delaying Aux Outs

To delay Aux Out 1–8 signals, press the [ $\phi$ /INSERT/DELAY] button repeatedly until the  $\phi$ /INS/DLY | Out Dly page appears.

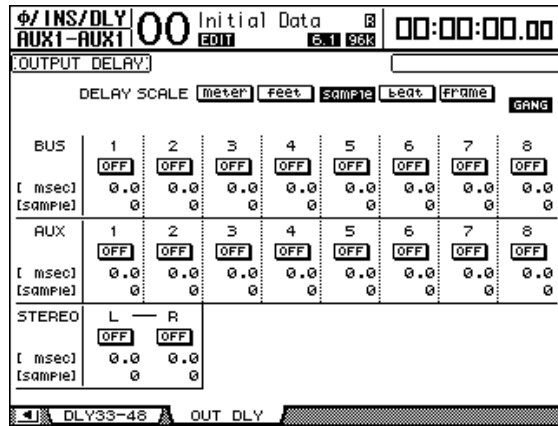

The parameters on this page (and the procedure for setting them) are the same as for Input Channels, except that this page does not have the MIX/FB.GAIN parameters (see page 61).

**Tip:** You can also display the Out Dly page by pressing the [ $\phi$ /INSERT/DELAY] button once, then selecting the desired Aux Out (1–8) by pressing the corresponding [SEL] button or moving the fader.

## Comp settings

To set the Aux Out 1–8 compressors, press the [DYNAMICS] button, then the [F3] button to display the Dynamics | Comp Edit page, and select the desired Aux Out 1–8 by using the corresponding [SEL] buttons or faders.

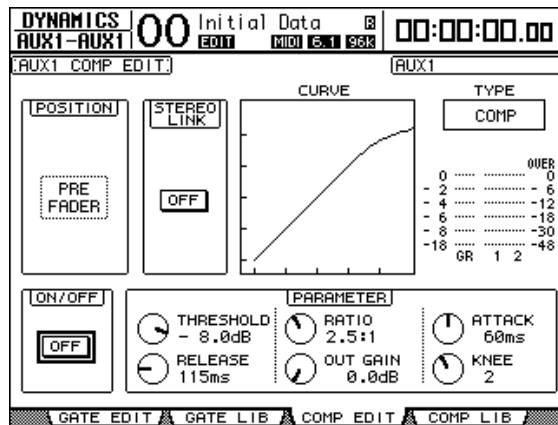

The parameters on this page (and the procedure for setting them) are the same as for Input Channels (see page 63).

## EQ settings

To set the EQ for Aux Out 1–8, press the EQUALIZER [DISPLAY] button repeatedly to display the EQ | EQ Edit page, and use the [SEL] buttons or faders to select Aux Out 1–8.

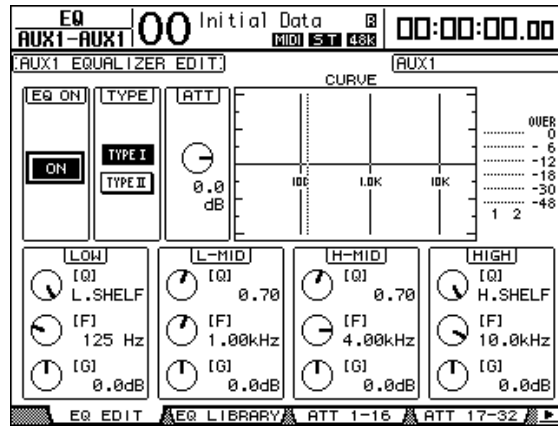

The parameters on this page (and the procedure for setting them) are the same as for Input Channels (see page 65).

## Viewing Aux Out settings

You can view and adjust the parameter settings for the currently-selected Aux Out on the View | Parameter and Fader pages.

### ■ Viewing the Compressor and EQ Settings

To display the View | Parameter page, use the corresponding [SEL] button or fader to select the desired Aux Out (1–8), then press the DISPLAY ACCESS [VIEW] button, then the [F1] button.

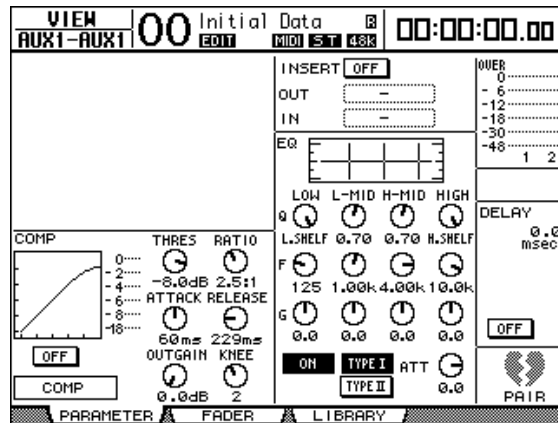

The parameters on this page (and the procedure for setting them) are the same as for Input Channels, except that this page does not include the Gate and Phase parameters (see page 69).

## ■ Viewing Faders and On/Off Parameters

To display the View | Fader page, use the corresponding [SEL] button or fader to select the desired Aux Out (1–8), then press the DISPLAY ACCESS [VIEW] button, then the [F2] button.

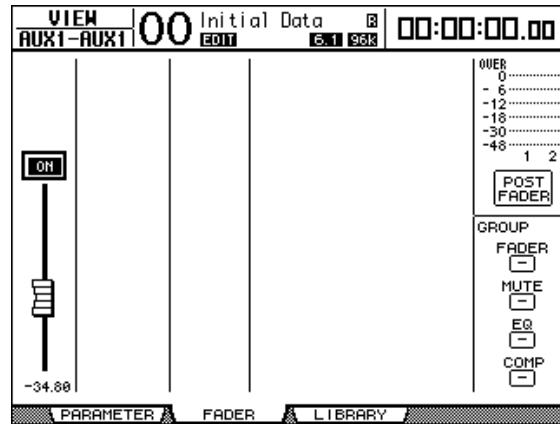

- **ON/OFF**..... This button turns the currently-selected Aux Out (1–8) on or off. It links with the corresponding [ON] (1–8) button in the Master layer.
- **Fader** ..... This fader sets the currently-selected Aux Out (1–8) level. It links with the corresponding fader (1–8) in the Master layer. The fader knob is highlighted when the fader is set to 0.0dB.

## Setting Aux Send Levels

You can adjust the level of signals routed from Input Channels to the corresponding Aux Out (1–8). To do this, you can either use the Encoders on the top panel or set the parameters on the screen.

### Using the Encoders

- 1 Press the **AUX SELECT [AUX 1]–[AUX 8]** buttons to select the sends.
- 2 Press the **ENCODER MODE [AUX]** button.  
When the ENCODER MODE [AUX] button is turned on, you can rotate the Encoders to set Aux Send levels.
- 3 Select a layer that contains the source Input Channels, then rotate the corresponding Encoders.

The DM1000 displays the Send level of the currently-selected channel.

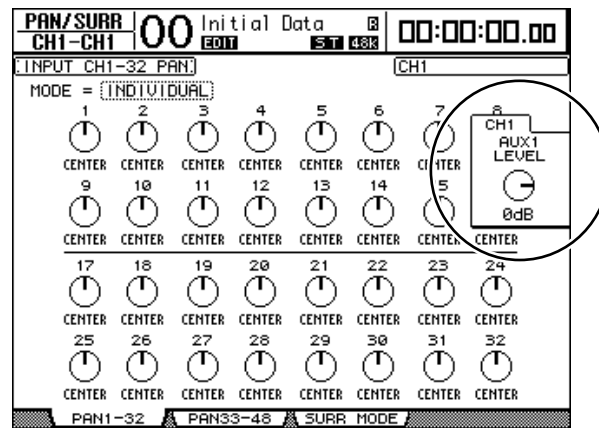

**Note:** If rotating the Encoders seems ineffective, check the Mode and Pre/Post parameters on the Aux | Send page (see page 97).



## Setting Send Levels from the Display

You can view multiple channels' Aux Send levels on the screen and adjust them individually.

- 1 Press the AUX SELECT [AUX 1]–[AUX 8] buttons to select the Aux Sends.
- 2 Press the AUX SELECT [DISPLAY] button repeatedly until the page listed below that contains the desired channels appears.
  - Send1-32 page  
This page displays the Aux Send levels of Input Channels 1–32.
  - Send33-48 page  
This page displays the Aux Send levels of Input Channels 33–48.

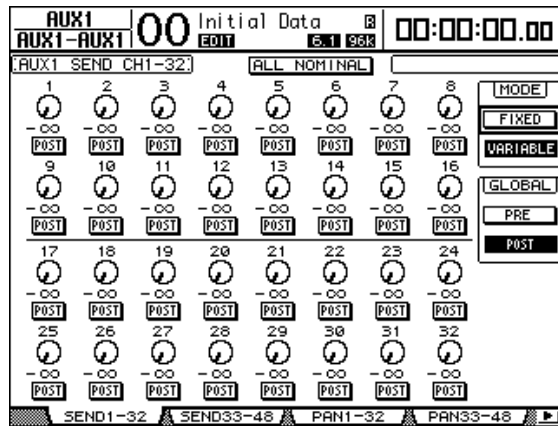

The parameters on these two pages (and the procedure for setting them) are the same.

- **Aux Send rotary controls**  
These controls adjust the Aux Send level of the Input Channels. The current numeric levels appear below the rotary controls.
- **PRE/POST**  
These buttons enable you to specify the Aux Sends signal source points. The PRE buttons send pre-fader signals, and the POST buttons send post-fader signals.
- **MODE**  
Aux Sends have two operating modes that determine how signals are sent: Fixed (Aux Send levels are fixed); and Variable (Aux Send levels are variable).
- **GLOBAL**  
The GLOBAL PRE and POST buttons enable you to set all Input Channels for the selected Aux Send to pre-fader or post-fader simultaneously.

**Note:** In Fixed mode, Aux Send ON/OFF buttons appear instead of the Aux Send rotary controls, PRE/POST buttons, and GLOBAL PRE/POST buttons. These ON/OFF buttons turn on or off each Input Channel for the currently-selected Aux Send.

**3 Move the cursor to the FIXED or VARIABLE button in the MODE section for the currently-selected Aux Send to select a mode.**

• **Fixed Mode**

In this mode, Aux Send levels are fixed at nominal (0.0dB). Also, channel ON/OFF buttons appear instead of the Send level rotary controls and PRE/POST buttons.

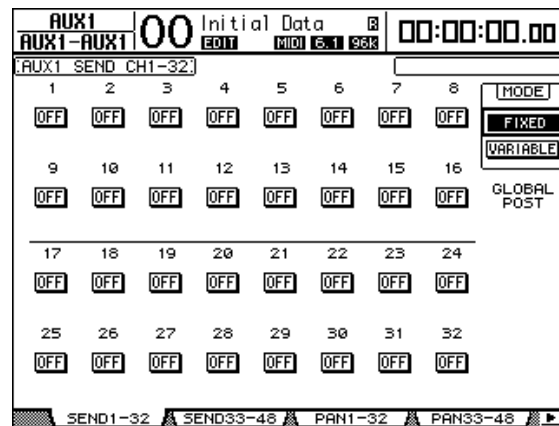

• **Variable Mode**

In this mode, Aux Send levels are variable and the signal source point can be either pre-fader or post-fader. Channel Send level rotary controls and PRE/POST buttons appear on the screen.

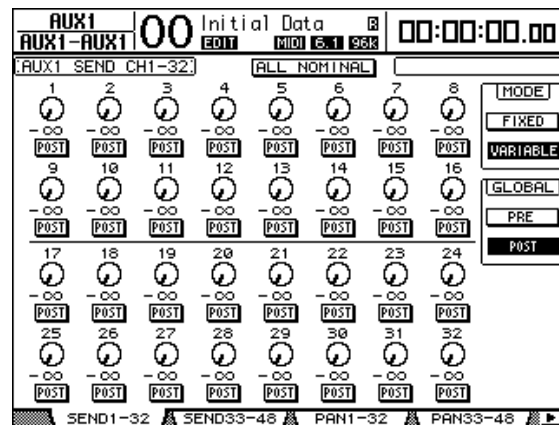

**Tip:** You can select Variable or Fixed mode individually for each of the eight Aux Sends.

**Note:**

- In Fixed mode, all ON/OFF buttons are turned OFF.
- When you switch to Variable mode, the signal source points are set to post-fader (PRE/POST buttons are set to POST), and Send level rotary controls are reset to  $-\infty$ .

- 4 If you switched to Fixed mode in Step 3, the ON/OFF buttons turn on or off for each Input Channel on or off for the currently-selected Aux Send.

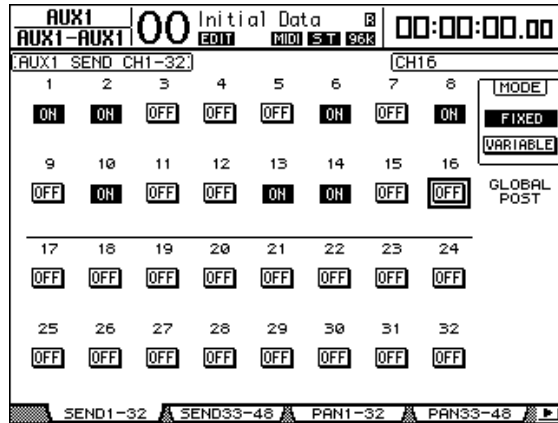

**Note:** In Fixed mode, the Aux On/Off parameters for paired Input Channels are not linked to each other.

- 5 If you switched to Variable mode in Step 3, the PRE/POST buttons and Send level rotary controls enable you to adjust the signal source points and Send levels.

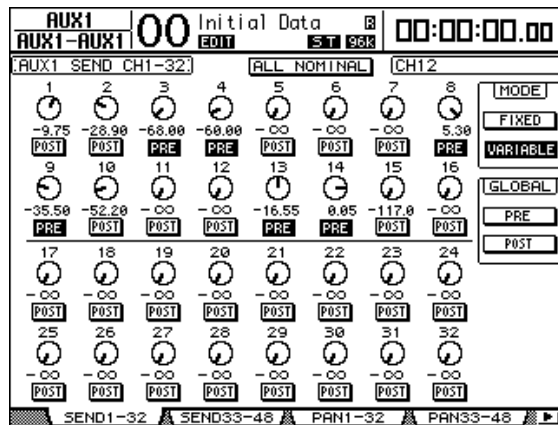

You can turn each Input Channel on or off for the currently-selected Aux Send even in Variable mode. To do this, move the cursor to the desired Send level control, then press [ENTER]. (The rotary controls for Off channels are grayed out.)

**Tip:**

- In Variable mode, Aux Send levels, Aux On/Off, and Pre/Post parameters for paired Input Channels are linked to each other.
- GLOBAL PRE/POST buttons enable you to set all Input Channels simultaneously (including those not displayed on the current page) to pre-fader or post-fader.

## Viewing Aux Send Settings for Multiple Channels

You can view and set parameters for all Aux Send 1–8, including setting levels and Pre/Post parameters.

This is convenient when you wish to visually check all Aux Send settings or simultaneously adjust the levels of certain channels routed to Aux 1–8.

**1 Press the AUX SELECT [DISPLAY] button repeatedly until the page listed below that contains the desired channels appears.**

- **View1–16 page**  
This page displays the Aux Send levels of Input Channels 1–16.
- **View17–32 page**  
This page displays the Aux Send levels of Input Channels 17–32.
- **View33–48 page**  
This page displays the Aux Send levels of Input Channels 33–48.

These pages display the source Input channels and the corresponding Aux Sends in a matrix. The parameters on these three pages (and the procedure for setting them) are the same.

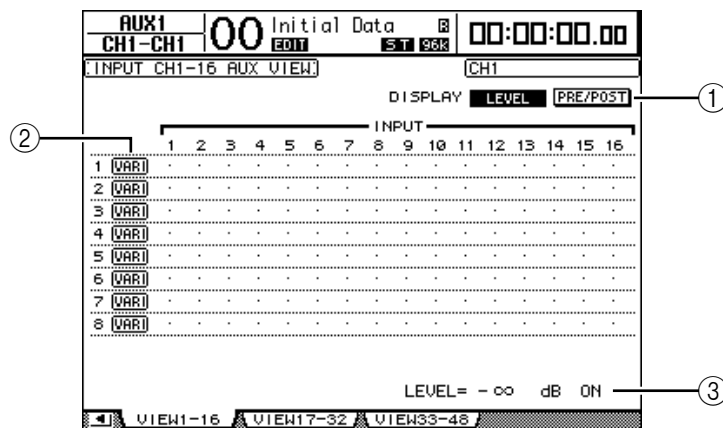

**① DISPLAY**

Use the following buttons to display the desired parameters.

- **LEVEL** ..... Select the LEVEL button to display Send level bar graphs for Input Channels routed to Aux 1–8.
- **PRE/POST** ..... Select the PRE/POST button to display signal source points for Input Channels routed to Aux 1–8.

**② FIX/VARI**

These buttons indicate the Aux mode (Fixed or Variable) for Aux Out 1–8 and are only for display purposes.

**③ LEVEL**

This field displays in dB the level of the Aux Send currently-selected by the cursor.

**2 Move the cursor to either the DISPLAY LEVEL or PRE/POST button and press [ENTER] to display the Level or Pre/Post parameters.**

- If you selected the PRE/POST button in Step 2, move the cursor to the desired Input Channel and Aux intersection, then press the [ENTER] button to change the signal source point.

		INPUT															
		1	2	3	4	5	6	7	8	9	10	11	12	13	14	15	16
1	[VARI]	P0	P0	P0	P0	P0	P0	PR	PR	P0	P0	P0	P0	P0	P0	PR	P0
2	[VARI]	P0	P0	P0	P0	P0	P0	P0	P0	P0	PR	P0	P0	P0	P0	P0	P0

**Note:** You can switch between Pre and Post only for Aux Sends that are set to Variable mode. The “FIX” indication appears for Aux Sends that are set to Fixed mode, and you cannot switch Pre/Post.

- If you selected the LEVEL button in Step 2, move the cursor to the desired Input Channel and Aux intersection, then edit the Send level or turn the currently-selected AUX Send on or off.

Rotate the Parameter wheel or press the [INC]/[DEC] buttons to set the Send level, and press the [ENTER] button to turn the currently-selected Aux Send on or off.

One of the following indicators appears, depending on the current Aux mode.

- Aux Sends in Fixed mode** ..... A “FIX” indicator appears for On Aux Sends, and a dot “.” appears for Off Aux Sends.

		INPUT															
		1	2	3	4	5	6	7	8	9	10	11	12	13	14	15	16
1	[FIX]	FIX	FIX	FIX	.	.	FIX	FIX	.	.	FIX	.	FIX	FIX	.	.	.
2	[VARI]	■	.	■	■		.	.	■		■	.	.	.	.	.	.

- Aux Sends in Variable mode** ..... The current Send levels are displayed by the bar graphs. If the level is set to nominal (0.0 dB), “N” appears in the bar. The bars for Aux Sends that are set to off are highlighted.

		INPUT															
		1	2	3	4	5	6	7	8	9	10	11	12	13	14	15	16
1	[FIX]	FIX	FIX	FIX	.	.	FIX	FIX	.	.	FIX	.	FIX	FIX	.	.	.
2	[VARI]	N	.	0	■		.	.	■	■	■	.	.	.	.	.	.

## Panning Aux Sends

You can pair adjacent odd-even (in this order) Aux Sends for stereo operation. This enables you to pan signals from Input Channels to paired Aux Sends.

- 1 **Pair the desired two Aux Sends.** (See page 87 for more information on pairing channels.)
- 2 **Use the AUX SELECT [AUX 1]–[AUX 8] buttons to select one of the paired Aux Sends.**
- 3 **Press the AUX SELECT [DISPLAY] button repeatedly until the page listed below that contains the desired channels appears.**
  - **Pan1–32 page**  
This page enables you to pan signals routed from Input Channels 1–32 to Aux Sends.
  - **Pan33–48 page**  
This page enables you to pan signals routed from Input Channels 33–48 to Aux Sends.

The parameters on these two pages (and the procedure for setting them) are the same.

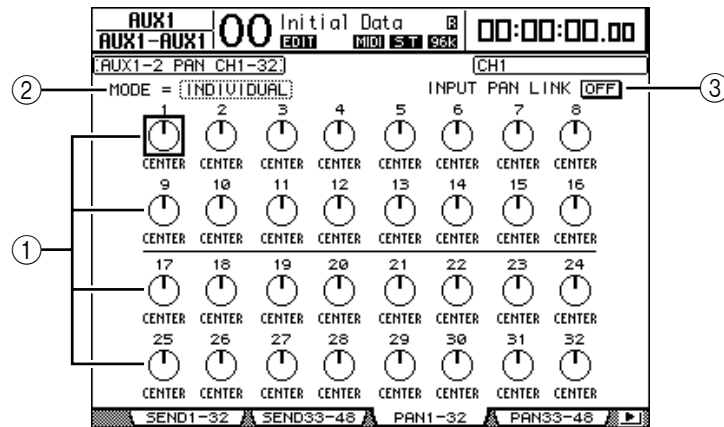

### ① Aux pan controls

These controls adjust the pan setting of signals routed from Input Channels to paired Aux buses.

### ② MODE

The MODE parameter determines how paired Input Channels are panned.

### ③ INPUT PAN LINK

When this parameter is turned on, Aux Sends follow the Input Channel Pan.

- 4 **Move the cursor to the Aux pan control of the desired Input Channel and rotate the Parameter wheel to set the pan value.**
- 5 **If necessary, move the cursor to the MODE parameter box and rotate the Parameter wheel to select INDIVIDUAL, GANG, or INV GANG, then press [ENTER].**

This Mode setting is independent of the Mode parameter on the Pan page. (See page 67 for more information on Mode options.)

- To link the Input Channel Pan setting with the Aux Send Pan setting, move the cursor to the INPUT PAN LINK ON/OFF button, then press [ENTER].

The pan positions on the Pan page are copied to the Aux pan setting, and the pan controls on both pages are linked.

**Tip:**

- If paired Aux Sends are in Variable mode, the Aux Send levels, Aux On/Off, and Pre/Post parameters for paired Input Channels are linked to each other.
- If paired Aux Sends are in Fixed mode, the Aux On/Off parameters for paired Input Channels are not linked to each other.

## Excluding Certain Channels from Aux Sends (Mix Minus)

You can quickly exclude signals from certain channels from Aux Sends by using the controls on the top panel. This operation is called “Mix Minus.”

For example, when Aux Sends are being used as monitors for the musicians or a narrator, you can turn off the audio signals of the musicians or narrator, excluding them from the monitor sound.

- Press and hold down the AUX SELECT [AUX 1]–[AUX 8] buttons of the desired Aux Sends.

The [ON] button indicators in the channel strip section remain lit while you hold down the button. This means that signals routed from channels with a lit [ON] button indicator to the Aux Send are turned on.

**Note:** If you release the button in the AUX SELECT section before you proceed to Step 2, you will be unable to complete the Mix Minus operation.

- Press the [ON] buttons of the Input Channels you wish to exclude from the Aux Send. You can select multiple channels.

The selected channels’ [ON] button indicators turn off, and signals routed from those channels to the corresponding Aux Send are turned off. “MIX MINUS FOR AUX \* ” appears on the bottom of the screen. (The asterisk represents an Aux number.)

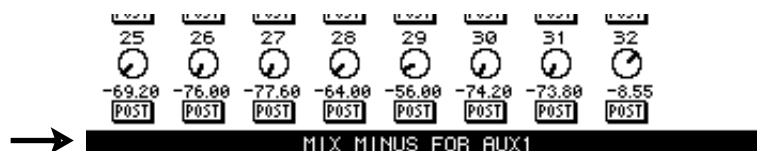

**Tip:** At this time, the Send Level controls on the Aux | Send page are grayed out.

- To reset the setting, while pressing and holding down the [AUX 1]–[AUX 8] buttons you pressed in Step 1, press the [ON] buttons you pressed in Step 2.

The corresponding [ON] button indicators light up.

## Copying Channel Fader Positions to Aux Sends

While Aux Sends are in Variable mode, you can copy all Input Channel fader positions on one layer to the corresponding Aux Sends.

This is convenient when you wish to send to the musicians monitor signals that have the same balance setting as the Stereo Out signals.

- 1 **Press and hold down the copy source layer (LAYER [1-16], [17-32], or [33-48]) button.**

*Note:* If you release the button in the LAYER section before you proceed to Step 2, you will be unable to complete the Copy operation.

- 2 **Press one of the AUX SELECT [AUX 1]–[AUX 8] buttons to select the desired Aux Send copy destination.**

The confirmation window for the Copy operation appears.

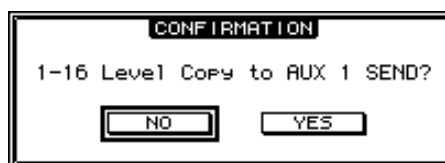

- 3 **To execute the Copy operation, move the cursor to the YES button, then press [ENTER].**

To cancel the Copy operation, move the cursor to the NO button, then press [ENTER].

*Tip:* If the copy destination Input Channel has been paired with a vertical partner in another Layer, the fader position will be copied to the partner's Aux Send.



# 9 Input & Output Patching

This chapter describes how to patch (assign) signal paths within the DM1000 to its inputs, outputs, and slot channels

## Input Patching

Signals input at INPUT connectors 1–16, 2TR IN DIGITAL connectors 1–2, and Slot I/O cards are patched to Input Channels for use.

Patch example:

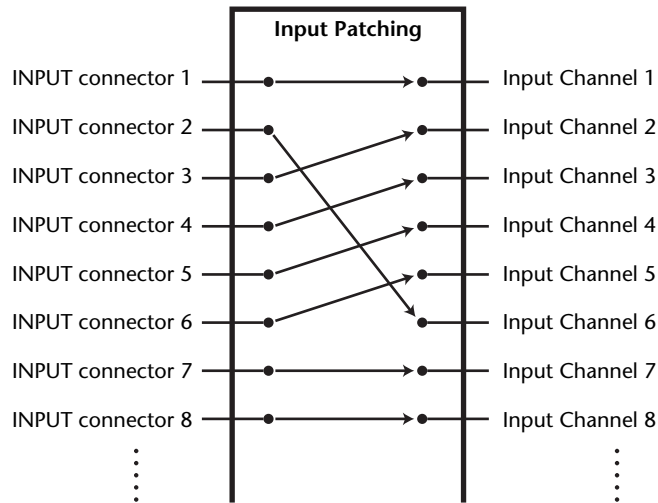

By default, the Input Channels are patched as follows:

Input Channels	Input connectors and Slot channels
1–16	INPUT connectors 1–16
17–24	Channels 1–8 of Slot 1
25–32	Channels 1–8 of Slot 2
33–40	Internal Effects Processor 1–4 Outputs 1–2
41/42	2TR DIGITAL IN 1 (L/R)
43/44	2TR DIGITAL IN 2 (L/R)
45–48	OMNI IN connectors 1–4

You can change these patches, if you desire. To change input patching, you can either use the Encoders on the top panel or set the parameters on the display.

## Input Patching from the Display

- 1 Press the DISPLAY ACCESS [INPUT PATCH] button repeatedly until the In Patch | In Patch page appears.

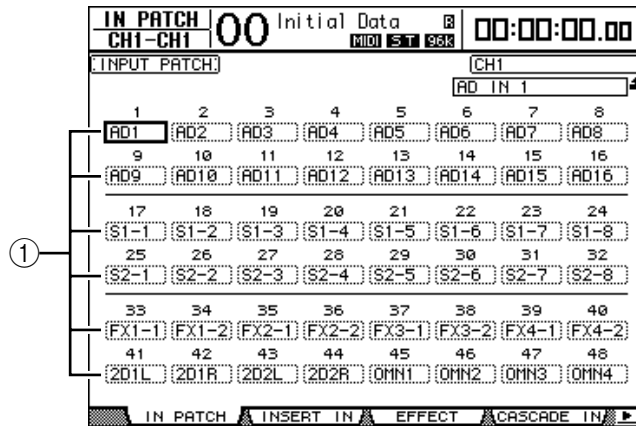

Inputs and slot channels that are currently assigned to Input Channels are shown in the parameter boxes (①) below the channel numbers. The parameter indicators are explained below:

Parameter values	Description
-	No assignment
AD1-AD16	INPUT connectors 1-16
OMN1-OMN4	OMNI IN connectors 1-4
S1-1-S116	Channels 1-16 of Slot 1
S2-1-S216	Channels 1-16 of Slot 2
FX1-1-FX1-8	Outputs 1-8 of Internal Effects Processor 1
FX2-1-FX2-2	Outputs 1 & 2 of Internal Effects Processor 2
FX3-1-FX3-2	Outputs 1 & 2 of Internal Effects Processor 3
FX4-1-FX4-2	Outputs 1 & 2 of Internal Effects Processor 4
2D1L & 2D1R	2TR DIGITAL IN 1 (L/R)
2D2L & 2D2R	2TR DIGITAL IN 2 (L/R)
BUS1-8	Bus 1-8 Outputs
AUX1-8	Aux 1-8 Outputs

- 2 Move the cursor to an input patch parameter you wish to change, and rotate the Parameter wheel or press the [INC]/[DEC] buttons to modify the patching.

The long name of the currently-selected channel is indicated in the upper-right corner of the screen (①). Below the channel name is the long name of the selected input/slot channel (②). (See page 249 for more information on changing channel names.)

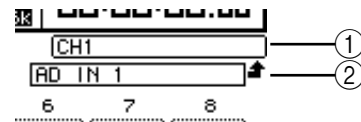

- 3 Press [ENTER] to confirm the change.

**Tip:**

- You can patch an input signal to multiple Input Channels.
- You can store the Input Patch settings to the Input Patch library. Refer to Chapter 15 “Libraries” on page 165 for more information.
- The number of outputs of internal Effects processor 1 varies depending on the selected effect program. (See page 147 for more information on effect programs.)

## Using the Encoders for Input Patching

By default, you can also use the Encoders on the top panel to change the Input Patching.

**1 Press the ENCODER MODE [ASSIGN] button. The button indicator lights up.**

By default, you can use the Encoders to change Input Patching while the [ASSIGN] button indicator is lit.

**Tip:** On the Encoder page, you can specify the Encoder function that works while the [ASSIGN] button indicator is lit (see page 35).

**2 Rotate the Encoder of the Input Channel for which you want to change patching. (Alternatively, press the corresponding Encoder push switch.)**

The In Patch | In Patch page appears, and the cursor moves to the corresponding Input Channel parameter box.

**3 Rotate the Encoder to select the desired input/slot channel number you want to patch.**

**4 Press the Encoder push switch to confirm the setting (or press the [ENTER] button).**

## Output Patching

The DM1000’s Stereo Out, Bus Out 1–8, Aux Out 1–8 signals can be patched to any outputs and slot channels.

**Patch example:**

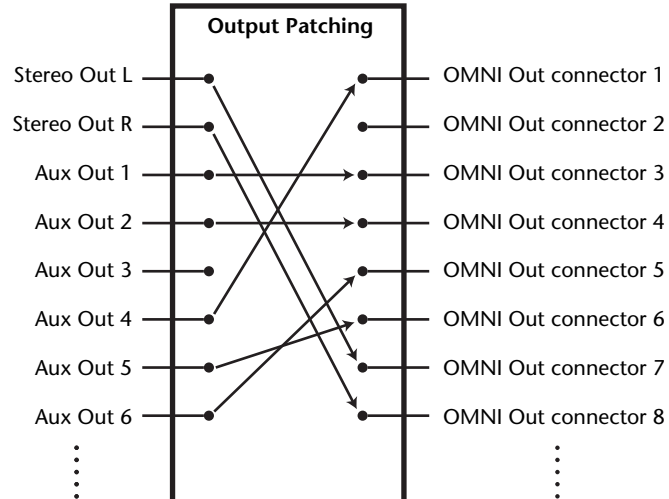

By default, the following signal paths are patched to outputs and slot output channels:

Output connectors and slot channels	Signal flow
OMNI OUT connectors 1–8	Aux Outs 1–8
OMNI OUT connectors 9–10	Stereo Out L & R
OMNI OUT connectors 11–12	Control Room Monitor L & R
Channels 1–8 of Slot 1	Bus Outs 1–8
Channels 9–16 of Slot 1	Bus Outs 1–8
Channels 1–8 of Slot 2	Bus Outs 1–8
Channels 9–16 of Slot 2	Bus Outs 1–8
2TR OUT DIGITAL 1 (L)	Stereo Out L
2TR OUT DIGITAL 1 (R)	Stereo Out R
2TR OUT DIGITAL 2 (L)	Stereo Out L
2TR OUT DIGITAL 2 (R)	Stereo Out R

**Tip:**

- You can patch a signal to multiple outputs and slot channels.
- You can store the Output Patch settings to the Output Patch library. Refer to Chapter 15 “Libraries” on page 165 for more information.

You can change these patches, if you desire. The procedure for patching signals to output varies depending on the output connectors and slots.

## Patching Omni Outs

You can route the DM1000's internal signals to OMNI OUT 1–8.

- 1 Press the DISPLAY ACCESS [OUTPUT PATCH] button repeatedly until the Out Patch | Omni Out page appears.

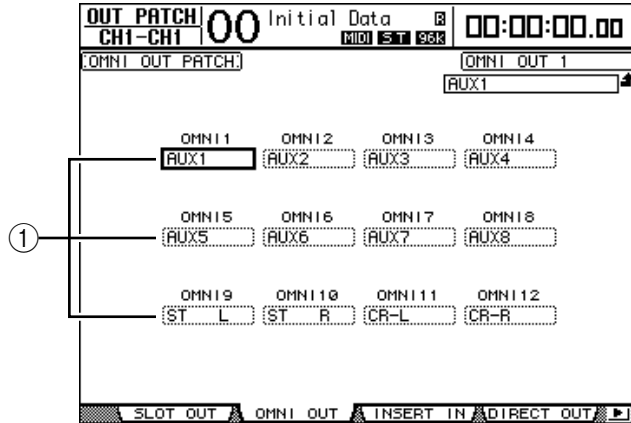

The OMNI 1–12 parameter boxes (①) indicate the currently-patched signals. The parameter indicators are explained below:

Parameter values	Description
–	No assignment
BUS1–BUS8	Bus Out 1–8 signal
AUX1–AUX8	Aux Out 1–8 signal
ST L/R	Stereo Out signal
INS CH1–INS CH48	Input Channel 1–48 Insert Out
INS BUS1–INS BUS8	Bus Out 1–8 Insert Out
INS AUX1–INS AUX8	Aux Out 1–8 Insert Out
INS ST-L/ST-R	Stereo Out Insert Out
SURR XXX ("XXX" represents a channel name.)	Surround Monitor Outs
CR-L/CR-R	Control Room Monitor signals
CAS BUS1–BUS8	Bus 1–8 Cascade Outs
CAS AUX1–AUX8	Aux Bus 1–8 Cascade Outs
CAS ST-L/ST-R	Stereo Bus Cascade Outs
CASSOLOL/CASSOLOR	Solo Bus Cascade Outs
SOLO-L/SOLO-R	Solo Bus signal
M.MX XXX ("XXX" represents a channel name.)	Surround Monitor Outs

- 2 Move the cursor to a patch parameter you wish to change, and rotate the Parameter wheel or press the [INC]/[DEC] buttons to modify the patching.
- 3 Press [ENTER] to confirm the change.

**Tip:** You can store the Output Patch settings to the Output Patch library. Refer to Chapter 15 "Libraries" on page 165 for more information.

## Patching the 2TR Digital Outputs

You can route the DM1000's internal signals to 2TR OUT DIGITAL connectors 1–2.

- 1 Press the DISPLAY ACCESS [OUTPUT PATCH] button repeatedly until the Out Patch | 2TR Out page appears.

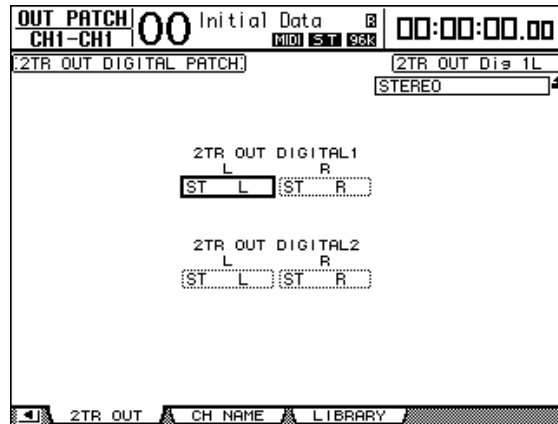

Signals assigned on the Omni Out page can also be assigned to the 2TR digital outputs.

- 2 Move the cursor to a patch parameter you wish to change, and rotate the Parameter wheel or press the [INC]/[DEC] buttons to modify the patching.
- 3 Press [ENTER] to confirm the change.

## Patching Slot Outputs

You can route the DM1000's internal signals to optional mini-YGDAI cards installed in Slot 1 and 2.

- 1 Press the DISPLAY ACCESS [OUTPUT PATCH] button repeatedly until the Out Patch | Slot Out page appears.

Signals assigned on the Omni Out page can also be assigned to the slot outputs.

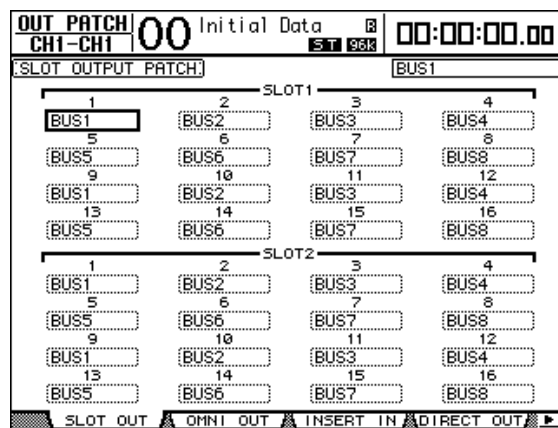

- 2 Move the cursor to a patch parameter you wish to change, and rotate the Parameter wheel or press the [INC]/[DEC] buttons to modify the patching.
- 3 Press [ENTER] to confirm the change.

## Patching Direct Outs

Input Channel 1–48 signals can be directly patched to any outputs or slot outputs, as well as Bus Out 1–8 and Stereo Out. This patching is convenient when you wish to record each Input Channel signal to an individual track on a connected recorder.

- 1 Press the **DISPLAY ACCESS [OUTPUT PATCH]** button repeatedly until the **Out Patch | Direct Out** page appears.

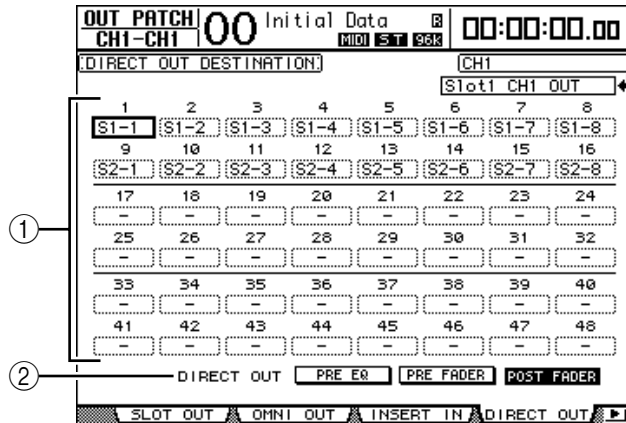

The parameters on this page are described below.

① **1–48**

These boxes indicate the Direct Out destination (outputs and slot channels) for Input Channels 1–48.

② **DIRECT OUT**

Determines the Direct Out signal source position from the following three options:

- **PRE EQ** ..... Immediately before Input Channel EQ
- **PRE FADER** ..... Immediately before Input Channel fader
- **POST FADER** ..... Immediately after Input Channel fader

- 2 Move the cursor to a patch parameter (1–48) you wish to change, and rotate the Parameter wheel or press the [INC]/[DEC] buttons to select the destination.

If necessary, specify the signal source position using the DIRECT OUT parameter.

- 3 Press [ENTER] to confirm the change.

*Note:* If you select a destination that has already been used for an output patch, the patch parameter box indicates “– (no assignment).” If you assign the Direct Out to an unused destination, the parameter box indicates the corresponding output.

- 4 Press the [SEL] button or move the fader of the Input Channel that is patched to the Direct Out assigned in Steps 2 and 3.

- 5 Press the **SELECTED CHANNEL ROUTING [DIRECT]** button.

The Direct Out patching is now effective, and the signals are routed to the assigned outputs or slot channels.

*Tip:* Press the **SELECTED CHANNEL ROUTING [DISPLAY]** button repeatedly to display the Routing page. On this page, you can simultaneously route multiple Input Channels to Direct Outs.

## Insert Patching

The DM1000's Input Channels and Output Channels (Stereo Out, Bus Out 1–8, Aux Out 1–8) feature independent Insert Ins and Outs. Inputs, outputs, slot channels, and internal effects processor inputs and outputs can be patched to the Output Channel Insert Ins and Outs. In this way, you can send the signals to external effects processors for processing, or insert internal effects.

### Individual Insert Patching

You can patch the DM1000's inputs, outputs, slot channels, and effects processor inputs and outputs to the Insert Ins and Outs. The same procedure applies to both Input Channels and Output Channels.

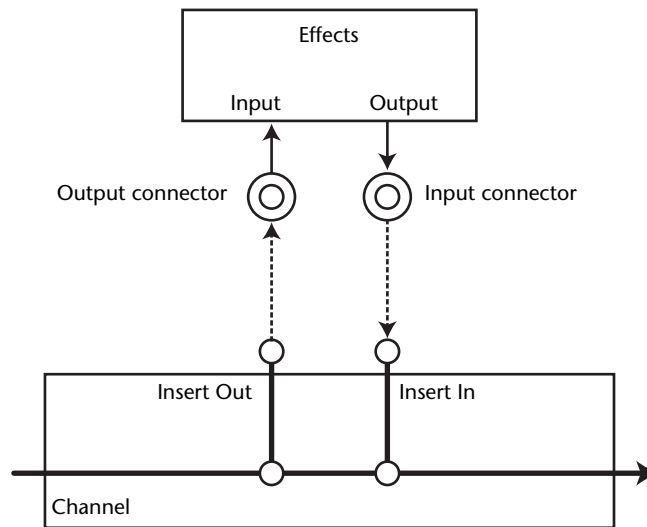

- 1 Press the [SEL] button or move the fader of an Input Channel or Output Channel for Insert patching.
- 2 Press the [ $\phi$ /INSERT/DELAY] button repeatedly until the  $\phi$ /INS/DLY | Insert page appears.

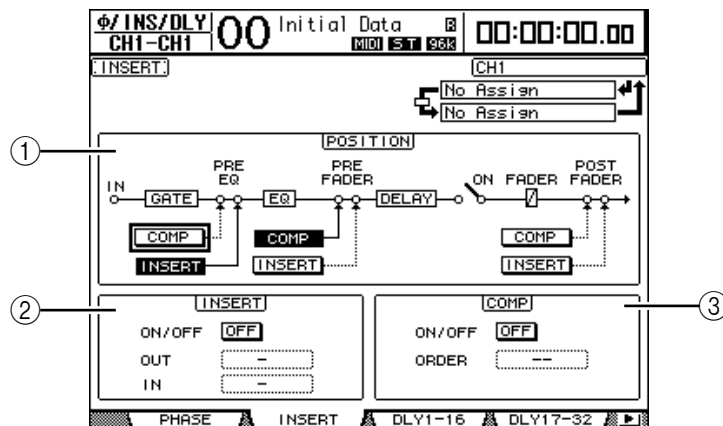

This page contains the following parameters:

① **POSITION**

This parameter determines the insert position of the Insert patch or compressor. The insert position is indicated by highlighted COMP or INSERT buttons.



② **INSERT section**

- **ON/OFF**..... This button turns Insert on or off.
- **OUT** ..... This parameter enables you to select outputs, slot channels, or internal effects inputs as the Insert Out destination.
- **IN**..... This parameter enables you to select inputs, slot channels, or internal effects outputs as the Insert In source.

③ **COMP section**

- **ON/OFF**..... This button turns the compressor on or off.
- **ORDER**..... This parameter determines the order of Insert patch and compressor when they are inserted at the same signal path point. With the “COMP → INS” setting, signals pass through the compressor first, then the Insert. With the “INS → COMP” setting, signals pass through the Insert first, then the compressor.

**3 Move the cursor to the OUT parameter box, and rotate the Parameter wheel or press the [INC]/[DEC] buttons to select the desired outputs, slot channels, or internal effects inputs to be patched to Insert Out. The parameter indicators are explained below:**

Parameter values	Description
–	No assignment
S1-1–S116	Channels 1–16 of Slot 1
S2-1–S216	Channels 1–16 of Slot 2
OMN1–OM12	OMNI OUT connectors 1–12
2D1L & 2D1R	2TR OUT DIGITAL1 (L/R)
2D2L & 2D2R	2TR OUT DIGITAL2 (L/R)
FX1-1–FX1-8	Inputs 1–8 of Internal Effects Processor 1
FX2-1 & FX2-2	Inputs 1 & 2 of Internal Effects Processor 2
FX3-1 & FX3-2	Inputs 1 & 2 of Internal Effects Processor 3
FX4-1 & FX4-2	Inputs 1 & 2 of Internal Effects Processor 4

**4 Press [ENTER] to confirm the change.**

If you move the cursor to another parameter box or display another page before you press the [ENTER] button, all settings on this page will be cancelled.

**5 Move the cursor to the desired IN parameter box, and rotate the Parameter wheel or press the [INC]/[DEC] buttons to select the inputs or slot channels to be patched to the Insert In.**

Refer to the explanation regarding the Input Patch for more information on the parameter values (see page 106).

**6 Press [ENTER] to confirm the change.**

***Tip:** Move the cursor to an empty OUT or IN parameter box and press the [ENTER] button. The Patch Select window appears. Rotate the Parameter wheel or press the cursor buttons to select an item to be patched and press [ENTER]. Then, move the cursor to the YES button and press [ENTER]. The selected item is now patched.*

**7 To enable the specified Insert patch, move the cursor to the ON/OFF button in the INSERT section, and press [ENTER] to turn it on or off.**

## Viewing and Changing Insert In Patch

You can view and also change the items patched to the Insert Ins of all Input Channels (or all Output Channels). This is useful when you wish to find out if multiple channels have the same patch.

- 1 To view the Input Channels' Insert Ins, press the [INPUT PATCH] button repeatedly until the In Patch | Insert In page appears.

This page displays Input Channels 1–48 Insert In Patches.

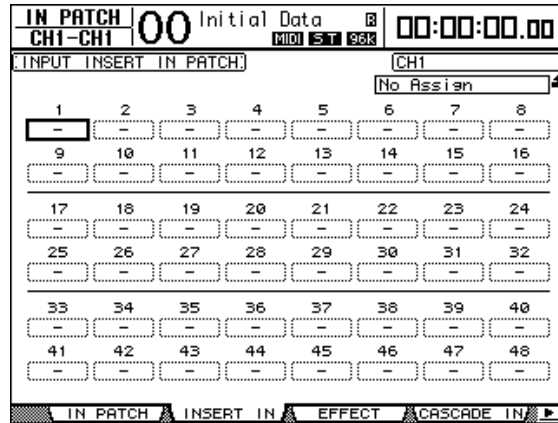

- 2 Move the cursor to a channel patch parameter box you wish to change, then rotate the Parameter wheel or press the [INC]/[DEC] buttons to modify the patching.
- 3 Press [ENTER] to confirm the change.
- 4 To view the Output Channels' Insert Ins, press the [OUTPUT PATCH] button repeatedly until the Out Patch | Insert In page appears.

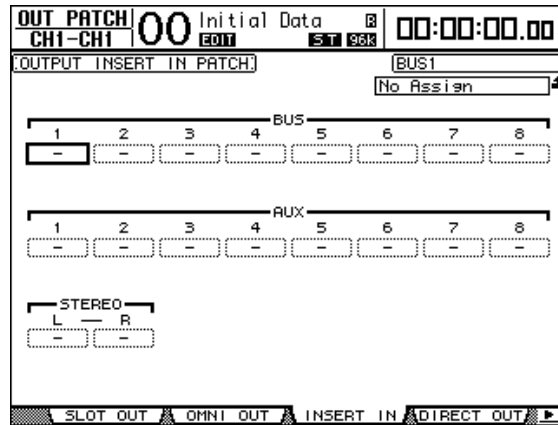

- 5 Move the cursor to a channel patch parameter box you wish to change, then rotate the Parameter wheel or press the [INC]/[DEC] buttons to modify the patching.
- 6 Press [ENTER] to confirm the change.

# 10 Control Room Monitoring

This chapter explains how to set up control room monitoring and use the Solo and Talkback functions on the DM1000.

## Control Room Monitor

The DM1000 features the Control Room stereo signal path to feed the control room's main monitors. By default, the Control Room signal source is patched to OMNI OUT connectors 11 & 12, which can feed the Control Room signal to the control room's monitor.

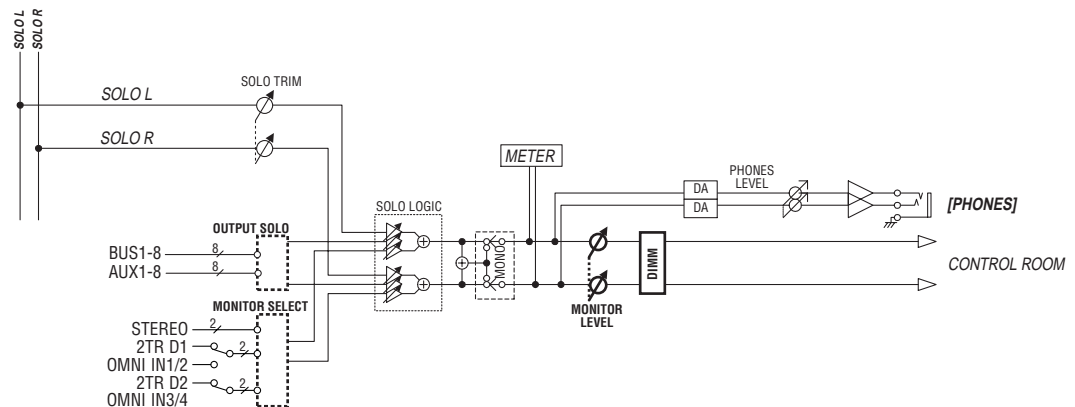

- **MONITOR SELECT**

As a Control Room Monitor signal, you can select one from Stereo Out output, 2TR IN DIGITAL 1 input, and 2TR IN DIGITAL 2 input.

If you change the parameter setting on the Monitor | Solo/C-R page (see page 116), you can monitor the OMNI IN signal, instead of the 2TR IN DIGITAL signal, when you press the [2TR D1] or [2TR D2] button.

- **SOLO bus**

This special bus routes soloed Input Channels to the Control Room Monitor output, bypassing Bus 1–8 and the Stereo Bus.

- **OUTPUT SOLO**

This section routes soloed Output Channels (Aux Out 1–8, Bus Out 1–8) to the Control Room Monitor output.

***Note:** Input and Output Channels cannot be solo-monitored simultaneously. The solo function for the most-recently soloed channels is enabled.*

- **MONITOR LEVEL**

Use the MONITOR [MONITOR LEVEL] control on the top panel to adjust the Control Room Monitor level.

- **DIMM (Dimmer)**

The [DIMMER] button lowers the Control Room Monitor signal by the specified amount.

***Note:** The Dimmer function is activated automatically when the Talkback or Oscillator function is active.*

- **PHONES**

The Control Room Monitor signal is also fed to the PHONES jack. You can set the level independently.

## Control Room Monitor and Solo Setup

For control room monitoring and solo setup, press the MONITOR [DISPLAY] button repeatedly until the Monitor | Solo/C-R page appears.

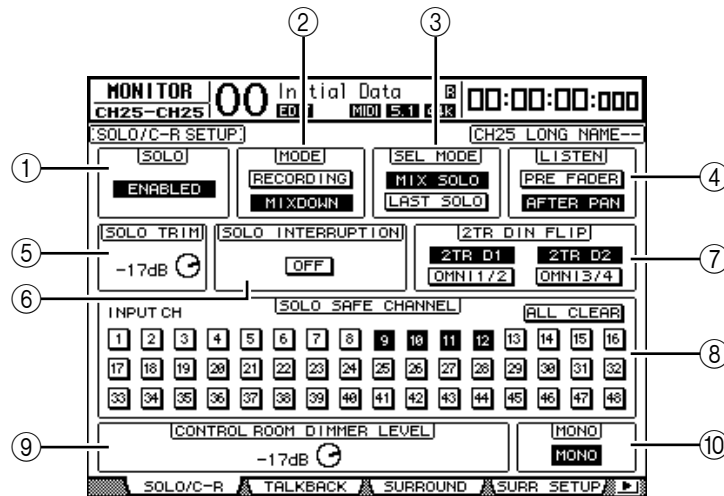

This page contains the following parameters:

① **SOLO**

This parameter turns the Solo function on or off. By default, it is set to Enabled.

② **MODE**

This parameter determines how the Solo function works. There are two options. The setting affects only Input Channels.

- **RECORDING** ..... In Recording Solo mode, soloed Input Channel signals are fed to the Solo bus and output via the Control Room Outputs. Other buses (Stereo bus and Bus 1–8) are unaffected by this mode.
- **MIXDOWN** ..... In Mixdown Solo mode, soloed Input Channel signals are fed to the Stereo bus and output via the Control Room Outputs. Unsoloed Input Channels are not fed to the Stereo bus while the Solo function is enabled.

**Tip:**

- Recording Solo mode is convenient when you wish to monitor certain Input Channels while recording, since the Stereo bus and Bus 1–8 signals are unaffected
- Mixdown Solo mode is useful when you wish to mute unsoloed Input Channels and feed soloed Input Channel signals to the Stereo bus during mixdown.

③ **SEL MODE**

This parameter determines how the Input Channels will be soloed when you press the [SOLO] button of each Channel. There are two options.

- **MIX SOLO** ..... In Mix Solo mode, any number of channels can be soloed simultaneously.
- **LAST SOLO** ..... In Last Solo mode, only one channel can be soloed at a time by pressing the [SOLO] button. The Solo function that was previously enabled for channels is automatically cancelled.

④ **LISTEN**

This parameter determines the source of the Input Channel Solo signal: Pre Fader or Post Pan. This parameter is effective only in Recording Solo mode.

**⑤ SOLO TRIM**

This parameter enables you to trim the level of the Solo signal in the range of  $-96$  dB to  $+12$  dB.

**⑥ SOLO INTERRUPTION**

When this parameter is set to Off, soloed channel signals are not fed to the Control Room Monitor outputs. To monitor the Control Room Monitor signals and soloed channel signals separately, change the output patching so that the soloed channel signals are output independently from the Control Room Monitor outputs, then turn the Solo Interruption parameter to Off.

**⑦ 2TR DIN FLIP**

This parameter enables you to specify the signal source that will be monitored when you press the MONITOR [2TR D1] or [2TR D2] button.

- **2TR D1 & OMNI 1/2 ...** These buttons select the 2TR IN DIGITAL 1 and OMNI IN 1/2 inputs respectively as the signal source that will be monitored when you press the [2TR D1] button.
- **2TR D2 & OMNI 3/4 ...** These buttons select the 2TR IN DIGITAL 2 and OMNI IN 3/4 inputs respectively as the signal source that will be monitored when you press the [2TR D2] button.

**⑧ SOLO SAFE CHANNEL**

For Mixdown Solo mode, Input Channels can be configured individually so that they are not muted when other Input Channels are soloed (Solo Safe function). Signals from Input Channels with the SOLO SAFE CHANNEL button turned on are always fed to the Stereo bus, regardless of the channels' Solo function status. You can clear all Solo Safe settings by turning on the ALL CLEAR button.

*Tip: For example, if you set the internal effects processor's return signal to Solo Safe, you can monitor the soloed "processed (or wet)" signals.*

**⑨ CONTROL ROOM DIMMER LEVEL**

This parameter determines the amount of attenuation applied to the Control Room Monitor signal by the Dimmer function when you press the MONITOR [DIMMER] button. The amount of attenuation can range from 0 dB to  $-96$  dB.

**⑩ MONO**

This button switches the Control Room Monitor signal into mono.

## Using the Control Room Monitor

- 1 **Connect a monitoring system to the outputs (by default, OMNI OUT 11&12) to which the Control Room Monitor signal is patched.**

To monitor the signal via headphones, connect headphones to the PHONES jack.

- 2 **Press the MONITOR [STEREO], [2TR D1], or [2TR D2] button to select the monitoring signal source.**

Each button selects the following monitoring signal sources:

- [STEREO] button ..... Selects the Stereo Out signal.
- [2TR D1] button ..... Selects the 2TR IN DIGITAL1 signal.
- [2TR D2] button ..... Selects the 2TR IN DIGITAL2 signal.

**Note:** In this case, the [2TR D1] and [2TR D2] buttons are effective only when external devices are connected to the 2TR Digital Outputs respectively and are turned on.

**Tip:** If you change the 2TR DIN FLIP parameter setting on the MONITOR | SOLO/C-R page (see page 116), you can monitor the 2TR Digital Input signal, instead of the OMNI IN signal, by pressing the [2TR D1] or [2TR D2] button.

- 3 **Adjust the monitoring level using the MONITOR [MONITOR LEVEL] control while playing the sound sources.**

To adjust the level of the monitoring signal via headphones, turn the [PHONE LEVEL] control.

## Using the Solo Function

You can solo and monitor Input Channels, Aux Out 1–8, and Bus Out 1–8 using the [SOLO] buttons on the top panel.

- 1 **Press the [DISPLAY] button repeatedly until the Monitor | Solo/C-R page appears.**
- 2 **Set the SOLO parameter to On and the SOLO INTERRUPTION parameter to Off.**

Set other parameters on the page, if necessary.

- 3 **To solo and monitor Input Channels, press the corresponding LAYER button to select a Layer that contains the desired channels, then press the channel [SOLO] buttons.**

The channel [SOLO] button indicators and the MONITOR [SOLO] indicator light up. Only the soloed Input Channel signals are fed to the Control Room Monitor outputs.

**Tip:** If the SEL MODE parameter is set to Mix Solo on the Monitor | Solo/C-R page, you can solo multiple Input Channels simultaneously.

- 4 **To solo and monitor Output Channels, press the LAYER [MASTER] button, then press the channel [SOLO] buttons.**

Input and Output Channels (Aux Out 1–8, Bus Out 1–8) cannot be solo-monitored simultaneously. For example, if you solo an Input Channel, then solo an Output Channel, the first solo channel is temporarily cancelled.

If you solo an Output Channel first, then solo an Input Channel, canceling the Input Channel's solo will activate the Output Channel's solo.

- 5 **You can unsolo all soloed channels by pressing all illuminated channel [SOLO] buttons.**

The button indicators turn off. You can also unsolo all soloed channels by pressing the MONITOR [CLEAR] button.

## Using the Talkback Function

The DM1000 features a built-in talkback microphone on the control surface. The Talkback function distributes the Talkback mic signal to the specified outputs or slot channels. The Talkback function is useful when you wish to communicate with the musicians in the studio or record your comments to a recorder.

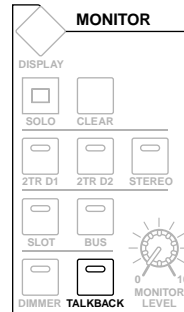

- 1 Press the MONITOR [DISPLAY] button repeatedly until the Monitor | Talkback page appears.

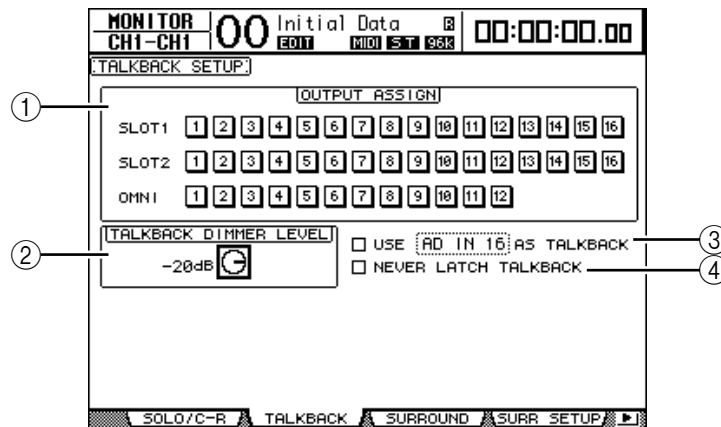

This page contains the following parameters:

- ① **OUTPUT ASSIGN section**  
The buttons in this section enable you to assign the Talkback mic signal to the desired outputs. (You can select multiple destinations.)
- ② **TALKBACK DIMMER LEVEL**  
When the Talkback function is active, this parameter determines the amount of attenuation applied to the Control Room monitor signals. The amount of attenuation can range from 0 dB to -96 dB.
- ③ **USE ..... AS TALKBACK check box**  
Checking this box enables you to select an AD Input or slot input channel signal specified in the parameter box as the Talkback signal source.
- ④ **NEVER LATCH TALKBACK check box**  
If this check box is checked, the Talkback function is enabled only while you are holding down the [TALKBACK] button. When you release the button, the Talkback function turns off. If the check box is unchecked, the Talkback function remains effective after you press and release the [TALKBACK] button.

- 2 Move the cursor to the number button of an output channel to which you wish to assign the Talkback signal in the OUTPUT ASSIGN section, then press the [ENTER] button to highlight the channel number.
- 3 If you wish to operate the [DIMMER] button during Talkback communication, move the cursor to the TALKBACK DIMMER LEVEL control and rotate the Parameter wheel or press the [INC]/[DEC] buttons to set the amount of attenuation.
- 4 Press the [TALKBACK] button.

The Talkback function is enabled.

By default, pressing and releasing the [TALKBACK] button once enables the Talkback function. Press the button again to turn off the function. If you press and hold down the [TALKBACK] button for more than 300ms, the Talkback function is enabled as long as you hold down the button, and the function is turned off when you release the button.

However, if you have checked the NEVER LATCH TALKBACK check box on the Monitor | Talkback page, the Talkback function remains effective only while you are pressing and holding down the button.



# 11 Surround Functions

This chapter describes surround panning, which determines how Input Channel signals are panned within and across the stereo field. It also describes the DM1000's surround monitoring capabilities, which enable you to monitor, in a surround sound environment, DM1000 surround mixes or surround sources input via the slots.

## Using Surround Pan

### About Surround Pan

The Surround Pan function places a sound image within a two-dimensional field using a multi-channel playback system, and pans the image to the front, rear, left, and right in relation to the listening position. To pan the stereo image, you can use the Parameter wheel, [INC]/[DEC] buttons, or Joystick.

You can also store the surround pan settings in a Scene, or record the movement of the sound image to Automixes. In addition to a normal Stereo mode, the DM1000 features the following three Surround modes:

- **3-1**  
This mode uses four channels that include front left, front right, front center, and rear.
- **5.1**  
This mode uses six channels that include front left, front right, rear left, rear right, front center, and subwoofer.
- **6.1**  
This mode uses seven channels that include six channels of 5.1 mode plus rear center.

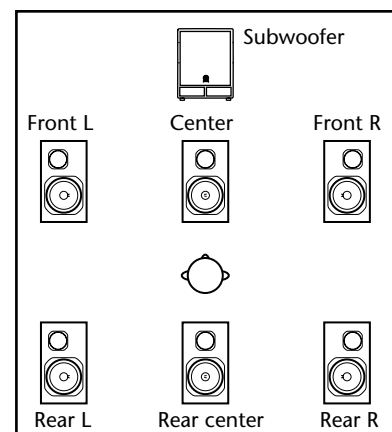
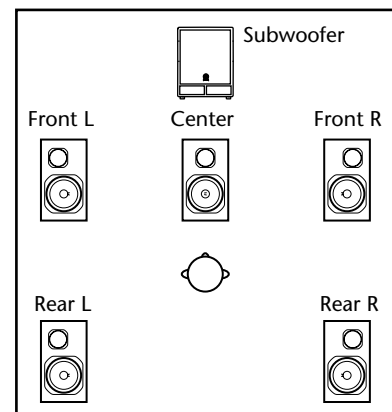
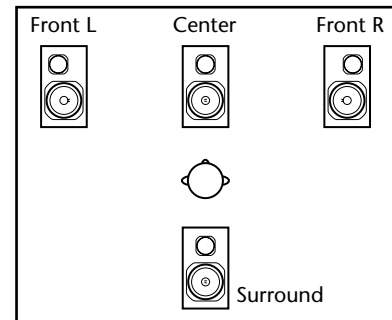

When you select one of these Surround modes, each surround channel is routed to the Buses specified on the Setup | Surr Bus page (see page 125).

The following table shows the factory-default Surround Channel to Bus Out assignment in each Surround mode.

Surround Mode	BUS1	BUS2	BUS3	BUS4	BUS5	BUS6	BUS7
3-1	L	R	C	S	—	—	—
	Front left	Front right	Center	Surround			
5.1	L	R	Ls	Rs	C	LFE	—
	Front left	Front right	Rear left	Rear right	Center	Subwoofer	
6.1	L	R	Ls	Rs	C	Bs	LFE
	Front left	Front right	Rear left	Rear right	Center	Rear center	Subwoofer

You can record each surround channel to a separate track to record surround panning. The following diagram is an example in which each channel signal in 5.1 Surround mode is recorded to digital MTR tracks.

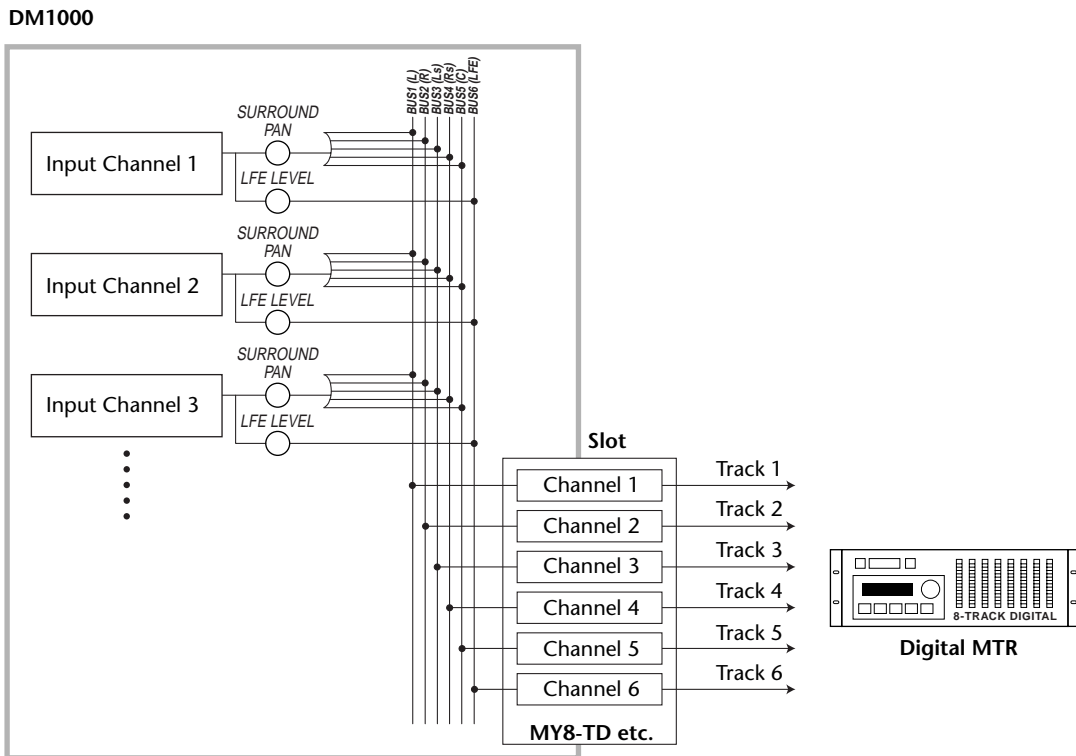

**Tip:** You can set the surround pan either independently of normal panpots or in unison with them.

## Setting Up and Selecting Surround Pan Modes

To configure the surround environment, select 3-1, 5.1, or 6.1 Surround mode on the DM1000 and connect a multi-channel monitoring system to the DM1000.

- 1 Press the **DISPLAY ACCESS [PAN/SURROUND]** button repeatedly until the **Pan/Surr | Surr Mode** page appears.

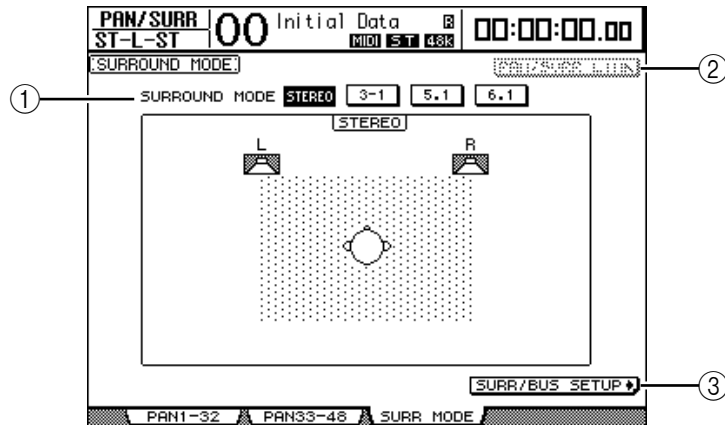

### ① SURROUND MODE

This parameter enables you to select a Surround mode by using the following buttons. The button that is turned on (highlighted) indicates the currently-selected Surround mode.

- **STEREO**.....The DM1000 uses normal stereo mode (default).
- **3-1**.....Selects 3-1 Surround mode.
- **5.1**.....Selects 5.1 Surround mode.
- **6.1**.....Selects 6.1 Surround mode.

### ② PAN/SURR LINK

When this button is turned on, Input Channel panpots and stereo surround panning are linked.

### ③ SURR/BUS SETUP

Press this button to display the Surr Bus page, which enables you to change the Surround Channel to Bus Out assignment.

- 2 Move the cursor to the Surround mode button you want to use.

When you move the cursor to one of these buttons, speaker icons appear, indicating a typical listening position and the Surround Channel to Bus Out configuration.

#### • 3-1 Surround

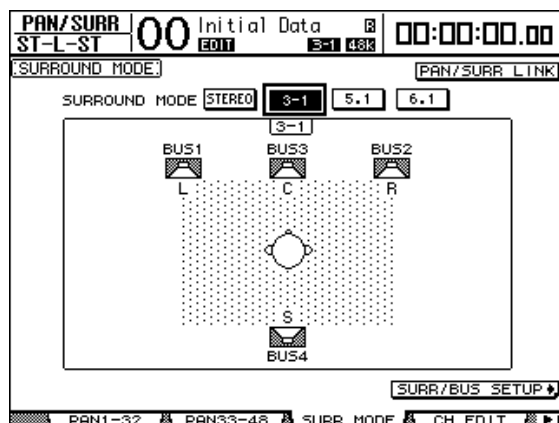

• 5.1 Surround

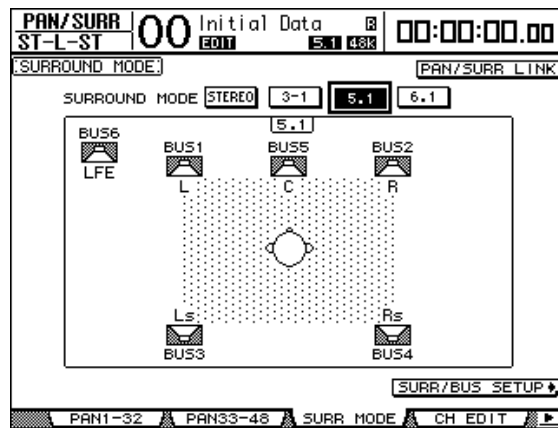

• 6.1 Surround

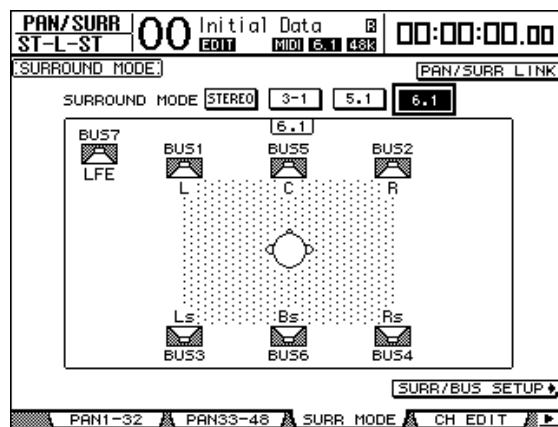

3 Press the [ENTER] button.

The confirmation window for changing the Surround mode appears.

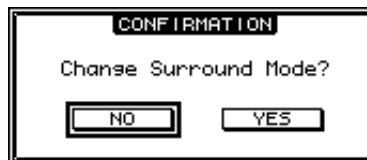

4 Move the cursor to the YES button, then press [ENTER].

The DM1000 enters the selected Surround mode.

5 To link the Input Channel Pan setting with the stereo surround panning, move the cursor to the PAN/SURR LINK button, then press [ENTER].

When the PAN/SURR LINK button is turned on, adjusting the Input Channel pan settings will also change the stereo surround panning accordingly, and vice versa.

- To change the Surround Channel to Bus Out assignment, move the cursor to the SURR/BUS SETUP button, then press [ENTER].

The Setup | Surr Bus page appears.

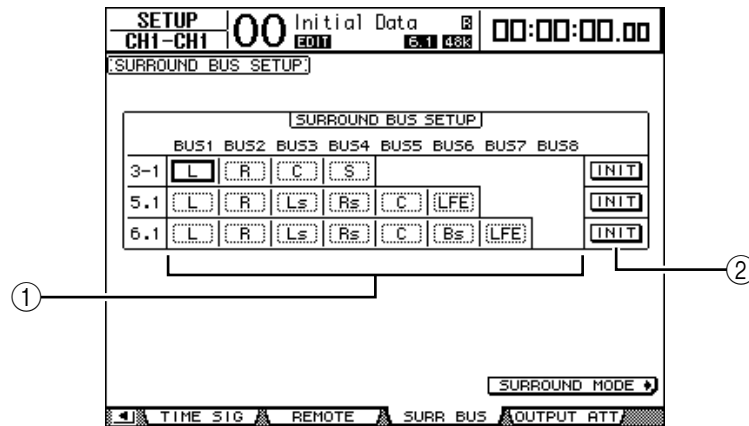

① **BUS1–BUS8**

These parameters select channels to be assigned to the Bus Outs in 3-1, 5.1, and 6.1 Surround modes.

② **INIT**

These buttons reset the channel assignment to the default setting.

- To change the assignment, move the cursor to the desired Bus parameter, rotate the Parameter wheel to select a channel, then press [ENTER].

The channels are swapped between the selected Bus and the Bus to which the channel assigned to the selected Bus was assigned previously.

**Tip:**

- Pressing the DISPLAY ACCESS [SETUP] button repeatedly also displays the Surr Bus page.
- Available Bus Outs vary depending on the Surround mode. For example, in 3-1 Surround mode, Bus Outs 1–4 are available. In 5.1 Surround mode, Bus Outs 1–6 are available, and in 6.1 Surround mode, Bus Outs 1–7 are available.

- Press the DISPLAY ACCESS [OUT PATCH] button repeatedly until the Out Patch | Slot Out page appears, then make sure that each Bus Out is routed to the desired channel on the digital I/O card.

To monitor signals routed to the digital I/O card in the surround environment, use surround monitoring (see page 131).

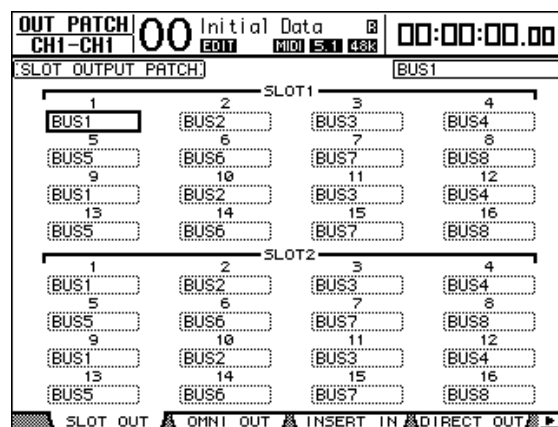

## Surround Panning from the Display

You can set the surround pan parameters for each Input Channel from the display.

- 1 Make sure that the DM1000 is in one of the Surround modes, then press the [SEL] button of the channel for which you want to set surround pan.
- 2 Press the DISPLAY ACCESS [PAN/SURROUND] button repeatedly until the Pan/Surr | Ch Edit page appears.

The Ch Edit page displays the selected Input Channel, and its surround pan setting and available pair partner.

The following display page is an example in 6.1 Surround mode.

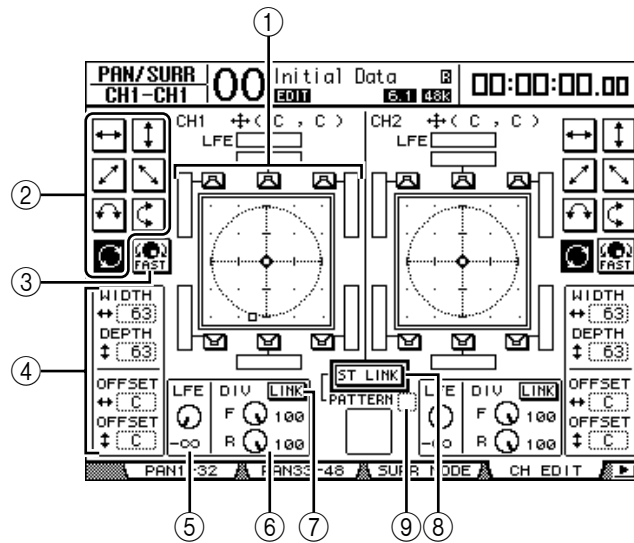

The following parameters are available on this page:

- ① **Surround pan graph**  
This graph indicates the pan positions in the two-dimensional field, with the listening position in the center. A small diamond (◆) indicates the current surround pan position, and a small square (■) indicates the current position of the Joystick. You can move the current surround pan position (◆) directly to one of the speaker icons by selecting its icon, then pressing [ENTER].
- ② **Trajectory patterns**  
These buttons represent seven trajectory patterns that determine how the surround pan moves when you operate the Parameter wheel or the [INC]/[DEC] buttons.
- ③ **FAST**  
Turning on this button increases the speed of sound images panned via the Parameter wheel.
- ④ **Trajectory pattern parameters**  
These parameters fine-tune the surround pan trajectory pattern.
  - **WIDTH** ↔ ..... This parameter sets the left-to-right width of the selected trajectory pattern.
  - **DEPTH** † ..... This parameter sets the front-to-rear width of the selected trajectory pattern.
  - **OFFSET** ↔ ..... This parameter offsets the left-to-right direction of the selected trajectory pattern.
  - **OFFSET** † ..... This parameter offsets the front-to-rear direction of the selected trajectory pattern.

⑤ **LFE**

This parameter control sets the level of the LFE (Low Frequency Effects) Channel signal routed to the subwoofer, and appears only in 5.1 and 6.1 Surround modes.

⑥ **DIV**

This parameter control determines how the Center signal is fed to the Left, Right, and Center channels. It is expressed as a percentage ranging from 0 to 100%. When you set the parameter to 100, the Center signal is fed to only the Center channel. When you set the parameter to 0, the Center signal is fed to only the Left and Right channels. When you set the parameter to 50, the Center signal is fed equally to the Left, Right, and Center channels. This parameter control appears only in 3-1 and 5.1 Surround modes.

⑥ **F & R**

In 6.1 Surround mode, F and R parameter controls appear, instead of the DIV control. The F parameter control determines how the Front Center signal is fed to the Left and Right channels, and the R parameter control determines how the rear surround signal is fed to the Left and Right surround channels.

⑦ **LINK**

This button is available only in 6.1 Surround mode. When you turn on this button, the F and R controls are set to the same value, and linked together.

⑧ **ST LINK**

Turning on this button links the surround pan parameters of two Input Channels that are currently displayed on the page (Stereo Link function). You can link the surround pan parameters of two channels regardless of whether they are paired.

⑨ **PATTERN**

When Input Channels are linked by the Stereo Link function, the seven patterns selectable here determine how the linked surround pan moves via the Parameter wheel and the [INC]/[DEC] buttons.

**Tip:** In 3-1, 5.1, and 6.1 Surround modes, operating the Joystick locates the Pan/Surr | Ch Edit page.

**3 Select one of seven trajectory patterns by turning on the corresponding trajectory pattern button.**

The following patterns are available:

-  ..... The sound image moves between left and right.

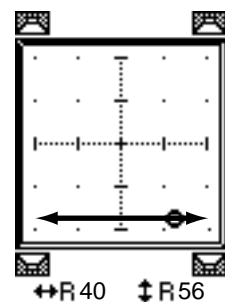
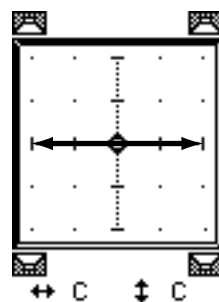
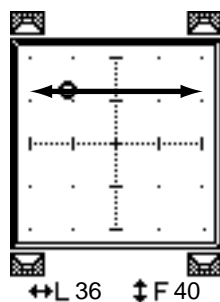

-  ..... The sound image moves between front and rear.

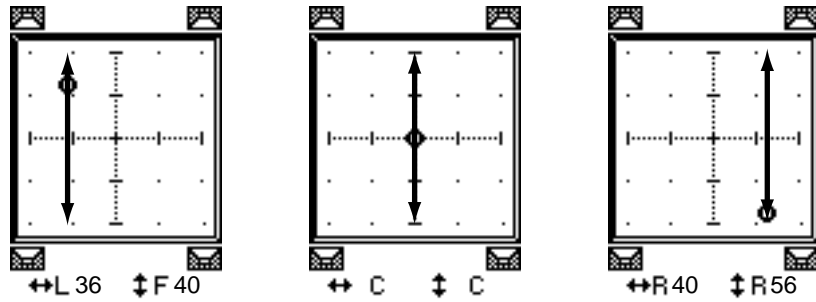

-  ..... The sound image moves from front right to rear left. With this pattern, you can also fine-tune the trajectory by using the WIDTH, DEPTH, OFFSET ( ↓ ), and OFFSET ( ↔ ) parameters.

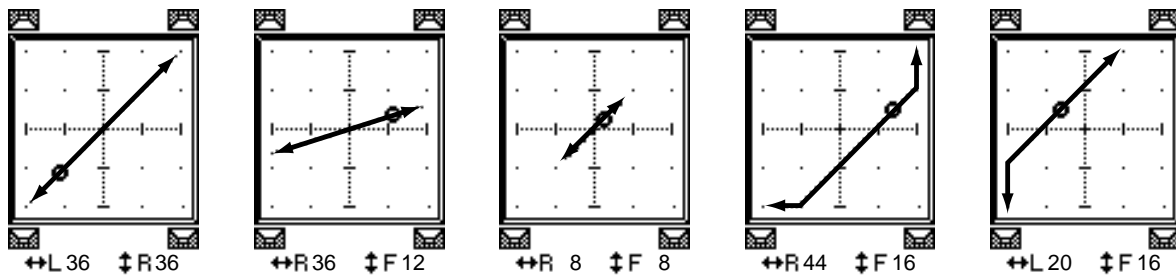

-  ..... The sound image moves from front left to rear right. With this pattern, you can also fine-tune the trajectory using the WIDTH, DEPTH, OFFSET ( ↓ ), and OFFSET ( ↔ ) parameters.

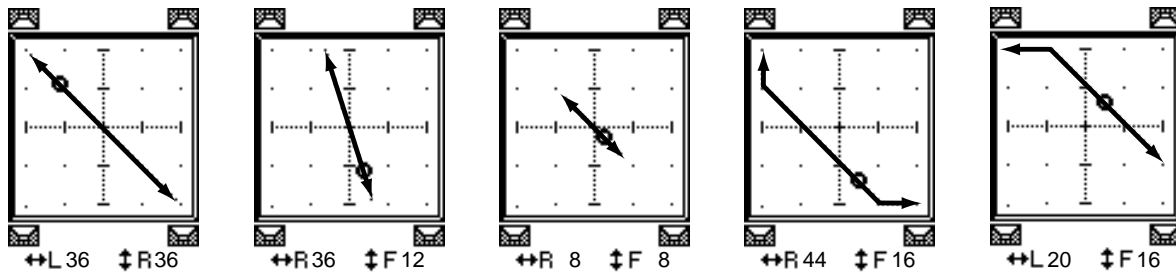

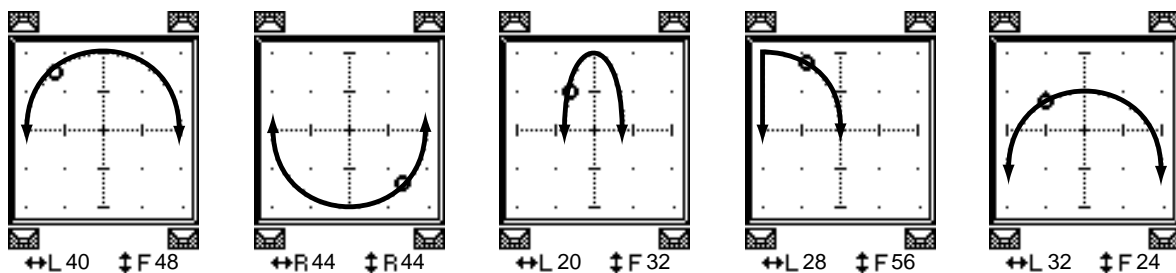

-  ..... The sound image moves between left and right while tracing an arc. With this pattern, you can also fine-tune the radius and shape of the arc using the WIDTH, DEPTH, OFFSET ( ↓ ), and OFFSET ( ↔ ) parameters.



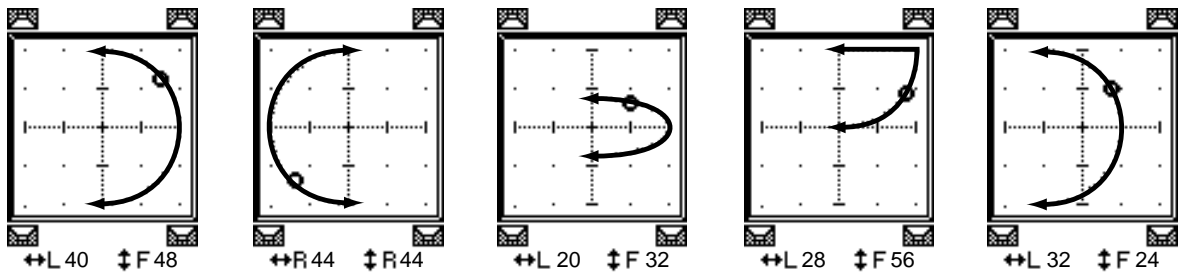

-  ..... The sound image moves between front and rear while tracing an arc. With this pattern, you can also fine-tune the radius and shape of the arc using the WIDTH, DEPTH, OFFSET (  $\updownarrow$  ), and OFFSET (  $\leftrightarrow$  ) parameters.



-  ..... The sound image moves while tracing a circle or oval. With this pattern, you can also fine-tune the radius and shape of the circle or oval using the WIDTH, DEPTH, OFFSET (  $\updownarrow$  ), and OFFSET (  $\leftrightarrow$  ) parameters.

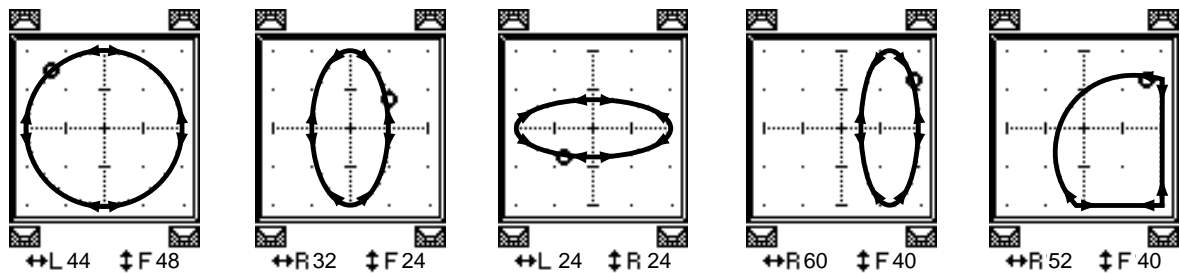

- If necessary, fine-tune the trajectory by editing the WIDTH, DEPTH, OFFSET (  $\updownarrow$  ), and OFFSET (  $\leftrightarrow$  ) parameter values.
- To set the surround pan position, move the cursor to anywhere outside the parameter boxes, then rotate the Parameter wheel.

*Tip:* You can also adjust the pan position using the Encoders if you assign the surround pan parameters to the Encoders.

- To adjust the surround pan using the Joystick, press the **SELECTED CHANNEL [GRAB]** button (the button indicator lights up), then operate the Joystick.

In this way, you can move the current pan position icons (  $\diamond$  ) directly and quickly. Even if the [GRAB] button is turned off, placing the small square (  $\square$  ) over the small diamond (  $\diamond$  ) will automatically turn on the [GRAB] button.

This Joystick function can be disabled by the Joystick Auto Grab preference (see page 252) on the Setup | Prefer1 page.

- To link the surround pan settings of two channels displayed on the page, turn on the **ST LINK** button.

Use the PATTERN parameter box below the ST LINK button to specify how you want the linked surround pan to move.

The following table shows how the sound images on two linked channels move when different trajectory patterns and stereo link patterns are combined. A solid line indicates the movement of the selected channel, and a dotted line indicates the movement of the linked partner.

Trajectory							
Pattern							

*Note: If you record the movement of the linked channels in an Automix, the sound image moves on both channels when you play the Automix.*

**8 To list multiple-channel surround pan settings, press the [PAN/SURROUND] button repeatedly until the Pan/Surr | Surr1-16, Surr17-32, or Surr33-48 page appears.**

These pages display and enable you to edit the surround pan settings for 16 channels.

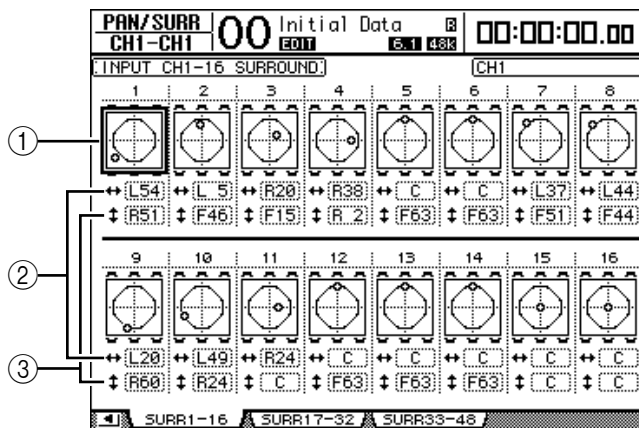

### ① Surround pan graphs

These graphs display the trajectory patterns and the current pan positions for the Input Channels. Move the cursor to the desired channel's graph, then rotate the Parameter wheel to adjust the pan settings along the selected trajectory pattern. Turning on the [GRAB] button enables you to use the Joystick to set the surround pan of the currently-selected Input Channel.

Press [ENTER] while the cursor is on the graph to display the Ch Edit page for the selected channel.

### ② ⇄ parameter box

This parameter box enables you to move the surround pan setting of the selected channel left and right.

### ③ ⚡ parameter box

This parameter box enables you to move the surround pan setting of the selected channel front and rear.

## Surround Monitoring

### About Surround Monitoring

The DM1000 features comprehensive surround monitoring functions that enable you to monitor, in the optimum environment, the surround sources in the Buses or those input from Slot 1 or 2. These functions include down mixing (which enables you to monitor signals on fewer channels) and fine-tuning of surround channel signals according to the monitoring environment.

The surround monitoring functions also feature an **oscillator** for testing speakers, a **monitoring matrix** for down mixing, **Bass Management** for optimizing channel signals for the monitoring environment, and **monitor alignment** using individual Attenuator and Delay parameters for each speaker.

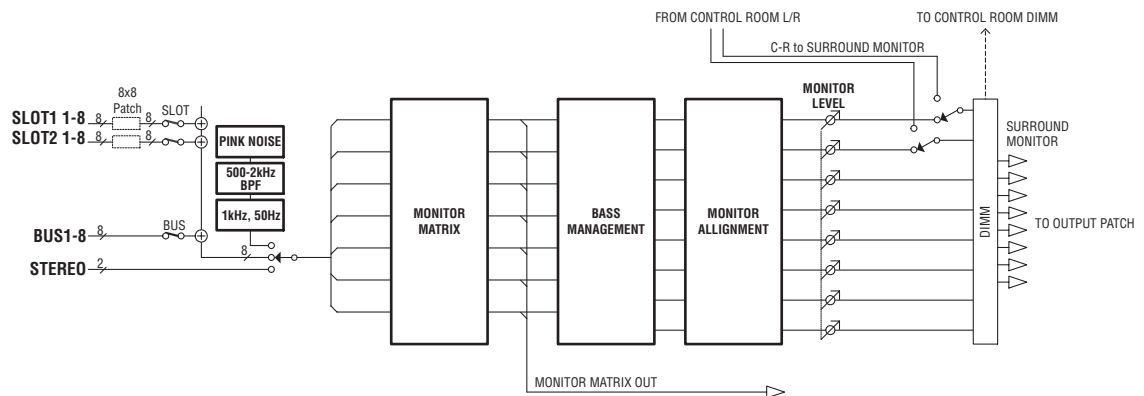

**To monitor the Surround Monitor signal via the surround system, you must connect the system to the output connectors on the DM1000, then patch the Surround Monitor signal source to these connectors.**

For example, if the surround system is connected to the OMNI OUT connector, press the [OUTPUT PATCH] button repeatedly until the Out Patch | OMNI Out page appears. This page will enable you to patch the surround channel (indicated as “SURR XXX” where “XXX” is the channel name) to the corresponding OMNI OUT connector.

The following diagram shows an example of 5.1 Surround Monitor signals patched to OMNI OUTs 1–6.

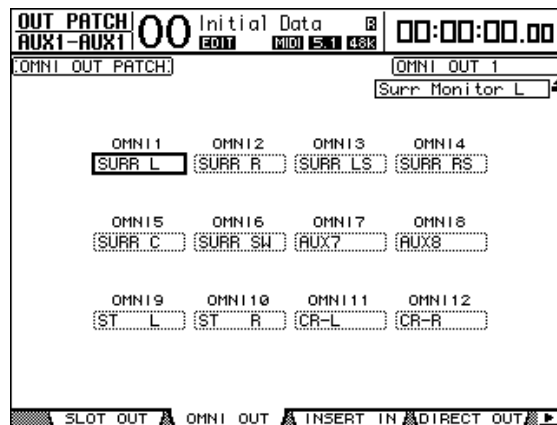

Use the following two buttons in the MONITOR section on the top panel to select the Surround Monitor signal source.

- **[BUS] button**

This button selects the Bus Outs assigned to the surround channels as the source. Turn on this button to check the effects of surround pan and surround effect settings, or to monitor a surround mix currently being recorded to a digital MTR.

- **[SLOT] button**

This button selects the Inputs of Slot 1 or 2 as the source. Turn on this button to monitor a surround mix from a connected multi-track recorder.

Use the MONITOR [MONITOR LEVEL] control on the top panel to adjust the Surround Monitor level.

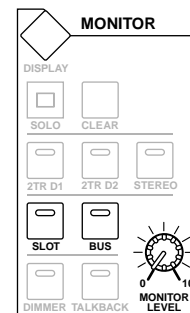

**Note:** If you turn on the [BUS] button while Surround mode is set to Stereo, the Stereo Bus signals are patched to Surround Monitor.

## Configuring Basic Surround Monitoring

You can set basic parameters for Surround Monitor, including **monitor matrix**, **Bass Management**, and **monitor alignment**.

To do so, press the MONITOR [DISPLAY] button repeatedly until the Monitor | Surr Setup page appears.

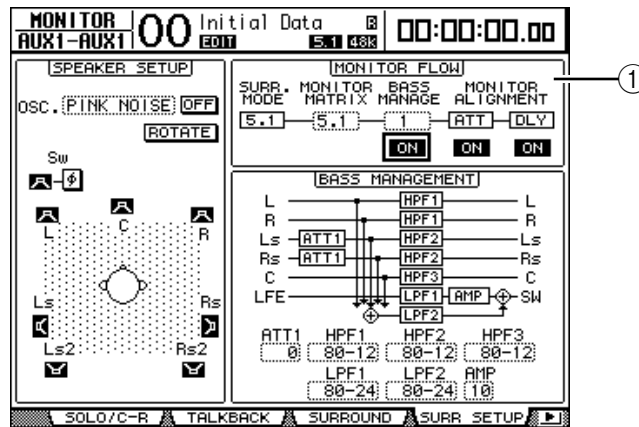

This page displays the basic parameter settings in the MONITOR FLOW section (①).

- **SURR. MODE**

This parameter indicates the current Surround mode. (You cannot change the Surround mode on this page).

- **MONITOR MATRIX**

This parameter selects a surround mode on the surround monitoring system. By default, it is set to the same mode as the SURR. MODE parameter, though you can select any mode that features fewer channels than the current mode. This function is useful when you wish to monitor, for example, a 5.1 surround source through a stereo monitoring system.

Available modes depend on the current Surround mode.

Surround Mode	ST	3-1	5.1	6.1
STEREO	O	—	—	—
3-1	O	O	—	—
5.1	O	O	O	—
6.1	O	O	O	O

When you change the Monitor Matrix mode in the MONITOR MATRIX parameter box, the area below the MONITOR FLOW section displays the Matrix flow diagram as well as ATT parameter boxes that enable you to adjust the amount of attenuation for each signal path. Adjust the attenuation, if necessary.

The following diagram shows an example in 5.1 Surround mode and 3-1 Monitor Matrix mode.

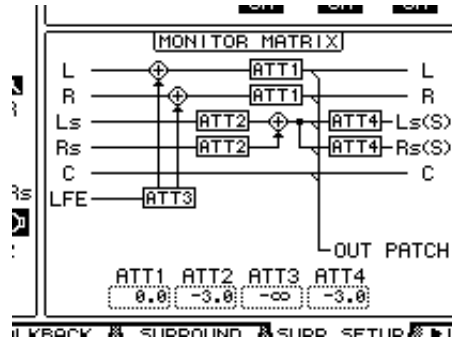

**Note:** You can patch the Surround Monitor Matrix channels to the output connectors.

• **BASS MANAGEMENT**

You can set the filter and attenuator settings for each Surround Monitor Channel using five preset Bass Management modes. The following presets are available:

Presets		Parameters				
No.	Title	HPF 1, 2, 3	LPF1	LPF2	ATT 1 & 2	AMP
1	DVD Mix w/BS	80-12	80-24	80-24	0	10
2	DVD Author w/BS	80-12	120-42	80-24	0	10
3	Film Mix w/BS	80-12	80-24	80-24	-3	10
4	Film Author w/BS	80-12	120-42	80-24	-3	10
5	Bypass	THRU	THRU	MUTE	0	0

ATT1: Adjusts the level difference between LR and LsRs.

ATT2: Adjusts the level difference between C and Bs.

AMP: Corrects the LFE channel level.

HPF1-3: Cut the low range so that the speakers' supporting frequency ranges will not interfere with the subwoofer signals.

HPF1-2: Cut the high range so that the subwoofer's supporting frequency ranges will not interfere with other speakers' signals.

**Tip:** If you select 3-1 Monitor Matrix mode, use Presets 1 or 2 to establish an appropriate monitoring environment.

You can set the Bass Management parameters in the following ranges:

Parameters	Range
HPF 1, 2, 3	THRU, 80-12, 80-12L, 80-24, 80-24L
LPF1	THRU, 80-24, 80-24L, 120-42
LPF2	THRU, 80-24, 80-24L, MUTE
ATT 1 & 2	0 to -12 dB (1 dB steps)
AMP	0 to +12 dB (1 dB steps)

The HPF 1, 2, 3, and LPF 1 & 2 values indicate a cut-off frequency and a filter response. For example, "80-12" means a cutoff frequency of 80 Hz and a filter response of -12 dB/octave.

"L" means Linkwitz filter. Other filters are Butterworth.

The following diagrams show the Bass Management configuration for each Monitor Matrix setting, with Bass Management turned on or off.

6.1 ON

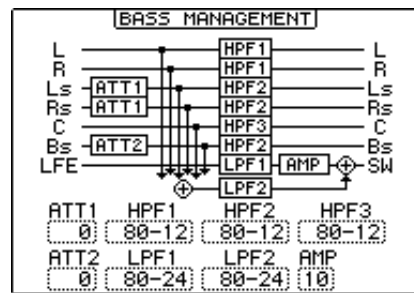

5.1 ON

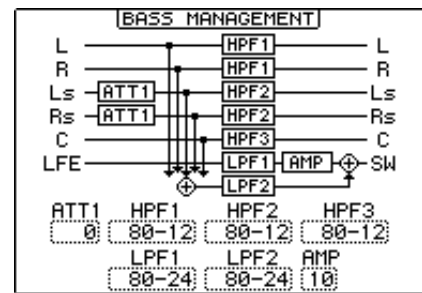

6.1 OFF

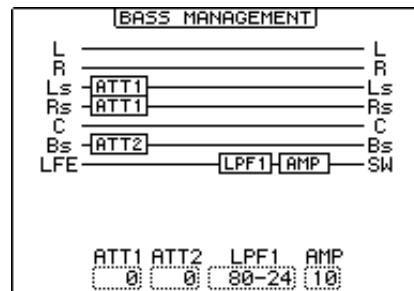

5.1 OFF

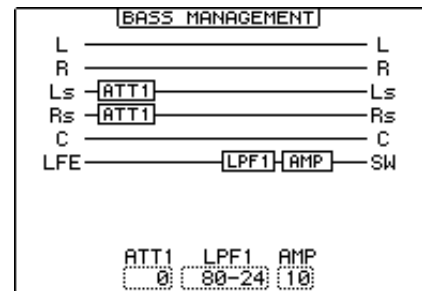

3-1 ON

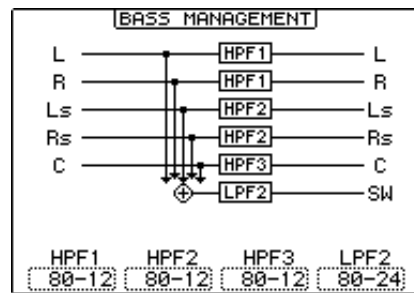

ST ON

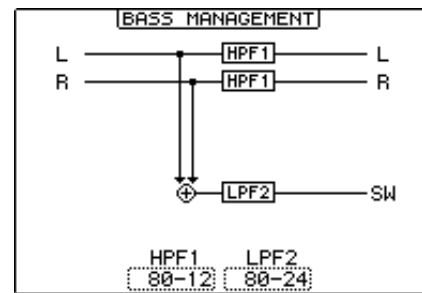

3-1 OFF

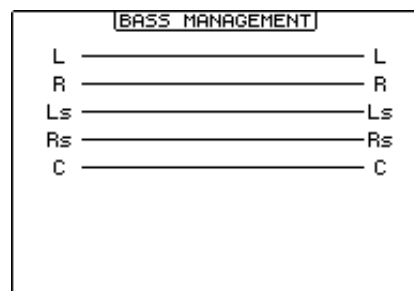

ST OFF

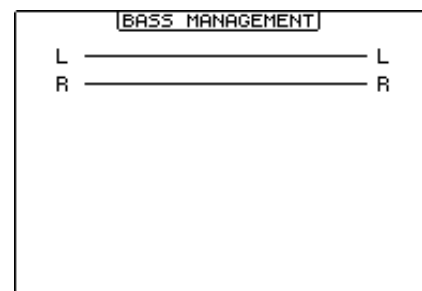

- **MONITOR ALIGNMENT**

You can adjust the Attenuator and Delay for each Surround Monitor Channel. This function is primarily used to correct the level difference and delay time among speakers.

Move the cursor to the ATT or DLY parameter in the MONITOR FLOW section. The MONITOR ALIGNMENT diagram is displayed in the area below the section.

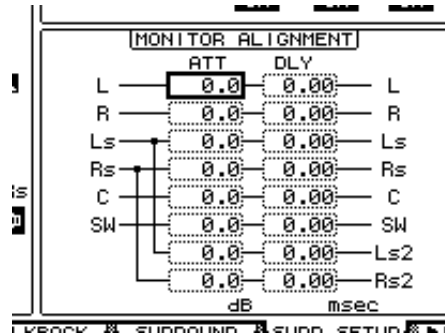

Move the cursor to the ATT or DLY parameter box and edit the Attenuator or Delay value. The Attenuator parameters can be set to  $-\infty$  dB or from  $-12.0$  dB to  $+12.0$  dB in  $0.1$  dB steps. The Delay parameters can be set from  $0.00$  to  $30.0$  msec in  $0.02$  msec steps.

**Note:** These parameter settings are effective only on the monitoring signals, not on normal Bus Out signals.

**Tip:** You can store these settings in the Surround Monitor library. See page 179 for more information.



## Setting the Monitoring Level of the Sound System

- 1 Adjust the monitoring levels using the MONITOR [MONITOR LEVEL] control. All channel monitoring levels change simultaneously.
- 2 Press the MONITOR [DISPLAY] button repeatedly until the Monitor | Surround page appears.

This page enables you to solo or mute monitoring channels, store the [MONITOR LEVEL] control setting, and select the monitoring source.

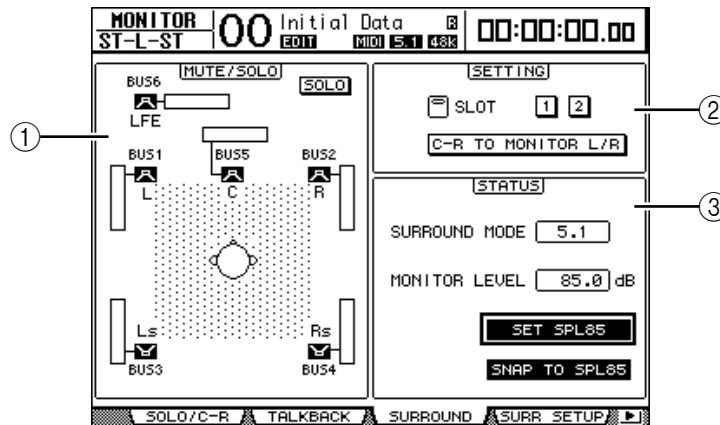

### ① MUTE/SOLO section

This section enables you to mute or solo Surround Monitor Channels for each Bus.

- **SOLO** ..... This button turns the Surround Monitor Solo function on or off. When this button is turned on, you can select speaker icons ( ) to solo certain Buses.
- **buttons** ..... These buttons mute or unmute the speakers. The meters connected to the speaker icons indicate the signal level of the corresponding Buses.

### ② SETTING section

- **SLOT 1 & 2** ..... These buttons determine which Slot Inputs are monitored through the Surround Monitor when you press the [SLOT] button. Turning on both buttons 1 and 2 mixes the two slot signals.
- **C-R TO MONITOR L/R** ..... When this button is turned on, the Left and Right Surround Monitor Channels are fed to the Control Room Monitors.

### ③ STATUS section

This section enables you to set the output levels of the currently-selected Surround Monitors.

- **SURROUND MODE** ... This parameter displays the current Surround mode.
- **MONITOR LEVEL** ..... This parameter indicates the current Surround Monitor level.
- **SET SPL85** ..... This button enables you to calibrate the volume setting of the [MONITOR LEVEL] control to 85 dB SPL, the cinema standard for setting up Surround Channel Monitor speakers, and then store the value.

- **SNAP TO SPL85**..... Turning on this button resets the [MONITOR LEVEL] control setting to the value stored by the SET SPL85 button.

**Note:** The Surround Monitor Mute and Solo functions are reset to the default condition when you change the Surround mode.

**3 Move the cursor to the SET SPL button, then press [ENTER] to turn on the button.**

The volume setting of the [MONITOR LEVEL] control is calibrated to 85 dB SPL and stored.

If you store the cinema standard level in this way, moving the cursor to the SNAP TO SPL85 button and pressing [ENTER] always restores the stored value, even after you adjust the [MONITOR LEVEL] control.

**Tip:** When the SET SPL button is turned on, the standard value (85.0 dB) indicated in the MONITOR LEVEL box is applied to the stored [MONITOR LEVEL] control setting.

### Using the Oscillator for Surround Monitor

The DM1000 features a dedicated Oscillator that enables you to check the output and sound of the surround sound speakers. You can send the Oscillator signal to certain speakers or to each speaker in turn. This function is useful when you wish to check the volume balance and phase of the surround monitor speakers.

**Tip:** This Oscillator is available only for Surround monitoring.

**1 Press the MONITOR [DISPLAY] button repeatedly until the Monitor | Surr Setup page appears.**

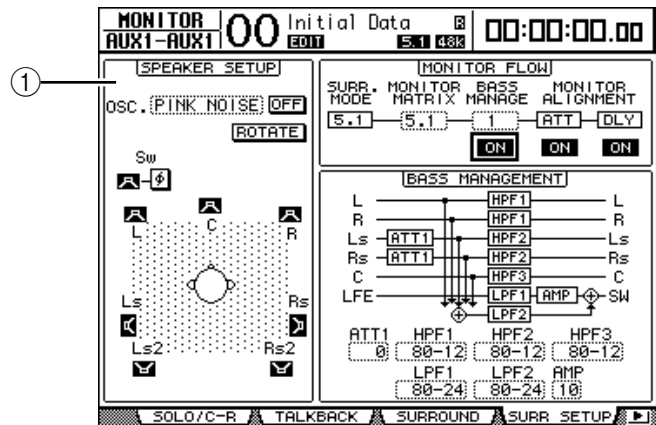

The SPEAKER SETUP section enables you to turn the Oscillator on or off and specify the signal destination.



**① SPEAKER SETUP**

You can select the Oscillator waveform and the speakers to which the Oscillator signal is sent.

- **OSC.** ..... This parameter selects the Oscillator waveform.
- **ON/OFF** ..... This button turns the Oscillator on or off.
- **ROTATE** ..... When the ROTATE button is on, the Oscillator signal is output by each speaker in turn, with an interval of five seconds (3-second signal and 2-second pause).
- **(Speaker) buttons**..... These buttons turn the Oscillator on or off for each speaker.

-  (SW Phase) button ..... This button reverses the phase of the signal output to the Subwoofer (SW).
- 2 **Make sure that the Speaker button (  ) for the speaker to which you want to output the Oscillator signal is turned on.**  
If the button is off, move the cursor to the button, then press [ENTER] to turn it on.
  - 3 **Move the cursor to the OSC. parameter box, then rotate the Parameter wheel or press the [INC]/[DEC] buttons to select one of the following Oscillator waveforms.**
    - PINK NOISE.....Pink noise
    - 500–2 kHz.....Pink noise through a 500 Hz to 2 kHz BPF
    - 1 kHz.....1 kHz sinewave
    - 50 Hz.....50 Hz sinewave
  - 4 **Move the cursor to the ON/OFF button, then press the [ENTER] or [INC]/[DEC] buttons to turn the Oscillator on.**  
The speaker specified in Step 2 outputs the Oscillator signal. If necessary, adjust the speaker volume balance in the MONITOR ALIGNMENT section on the Surr Setup page (see page 136).

## Patching Slot Inputs to Surround Channels

You can patch individual Slot Inputs to Surround Monitor Channels as follows.

- 1 **Make sure that the DM1000 is in the same Surround mode as the monitoring source.**
- 2 **Press the MONITOR [SLOT] button.**  
Slot 1 or 2 Input is selected as the surround monitor source.
- 3 **Press the MONITOR [DISPLAY] button repeatedly until the Monitor | Surr Patch page appears.**  
This page enables you to make the Slot Input to Surround Monitor Channel assignment.

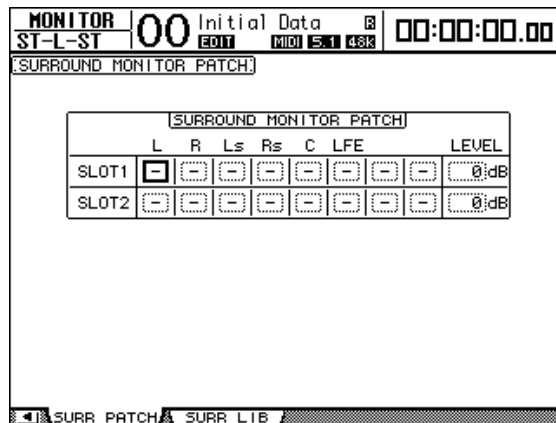

- 4 **Move the cursor to a patch parameter for which you want to change the assignment, and rotate the Parameter wheel to select a slot channel to be assigned to the Surround Monitor channel.**  
To assign no channels, select “-.” Set all unnecessary channels to “-.”

- 5 If necessary, move the cursor to the LEVEL parameter box, then use the Parameter wheel to adjust the Slot Input levels simultaneously.**

You can adjust the signal levels in the range of –96 dB to +12 dB .

- 6 Press the MONITOR [DISPLAY] button repeatedly until the Monitor | Surround page appears.**

In the SETTING section of the Surround page (see page 137), you can select a Slot Input to be monitored.

- 7 Move the cursor to the SLOT 1 or 2 button in the SETTING section, then press [ENTER] to select the desired monitoring Slot Input.**

You can now monitor the selected Slot Input source via Surround Monitor.

**Tip:** *You can make a surround source channel assignment for each Surround mode.*

# 12 Grouping Channels & Linking Parameters

This chapter describes how to group faders or [ON] buttons for multiple channels and link the EQ or compressor parameters for simultaneous operation.

## Grouping & Linking

On the DM1000, you can group faders or [ON] buttons for multiple Input Channels or multiple Output Channels (Bus Outs 1–8, Aux Outs 1–8) and link the EQ or compressor parameters.

The following elements can be grouped or linked within Input Channels or Output Channels.

- **Fader group**

Input Channel or Output Channel faders can be grouped. There are eight Input Channel Fader groups and four Output Channel Fader groups. When channel faders are grouped, operating one of them enables you to control the level of the other grouped faders while maintaining the relative level differences.

- **Mute group**

Input Channel or Output Channel [ON] buttons can be grouped. There are eight Input Channel mute groups and four Output Channel mute groups. When channel [ON] buttons are grouped, pressing any one of them turns the [ON] buttons for all the grouped channels on or off. A mute group can include On channels and Off channels at the same time, which turn off or on respectively when you press any one of the grouped [ON] buttons.

- **EQ Link**

Input or Output Channel EQ parameters can be linked. There are four EQ links for Input Channels and Output Channels respectively.

All channels in an EQ link share the same EQ parameter settings. When you change an EQ parameter value for one of the linked channels, the change is applied to all other linked channels.

- **Compressor Link**

Input or Output Channel compressor parameters can be linked. There are four compressor links for Input Channels and Output Channels respectively.

All channels in a compressor link share the same compressor parameter settings. When you change a compressor parameter value for one of the linked channels, the change is applied to all other linked channels.

## Using Fader Groups and Mute Groups

Follow the steps below to group faders or [ON] buttons for Input Channels or Output Channels (Bus Outs 1–8, Aux Outs 1–8).

**1 Press the DISPLAY ACCESS [PAIR/GROUP] button repeatedly until one of the pages that contains the desired group and channels appears.**

- **Fader1–32 page**
- **Fader33–48 page**  
These pages enable you to set Fader groups (A–H) for Input Channels 1–48.
- **Out Fader page**  
This page enables you to set Fader groups (Q–T) for Bus Outs (1–8) and Aux Outs (1–8).

• **Fader1–32 page**

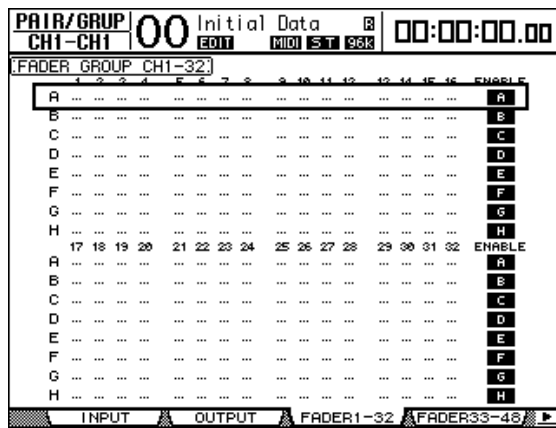

- **Mute1–32 page**
- **Mute33–48 page**  
These pages enable you to set Mute groups (I–P) for Input Channels 1–32 and 33–48 respectively.

- **Out Mute page**  
This page enables you to set Mute groups (U–X) for Bus Outs (1–8) and Aux Outs (1–8).

• **Mute1–32 page**

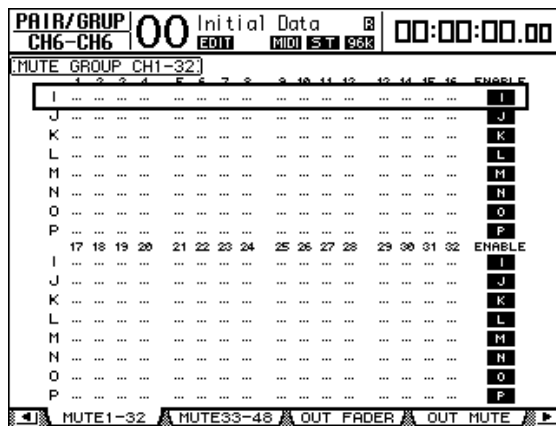

**2 Press the up (▲) or down (▼) button to select a group.**

Example: Fader group C is selected.

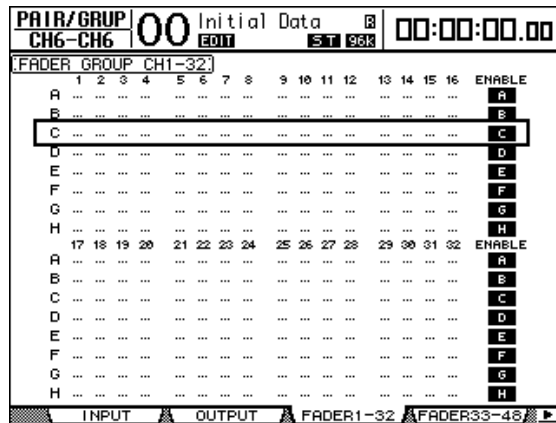

**3 Press the [SEL] button for a channel you wish to add to the group.**

The selected channel is marked with “●” and the channel is added to the group.

Example: Input Channels 1–6, and 13–14 have been added to Fader group C.

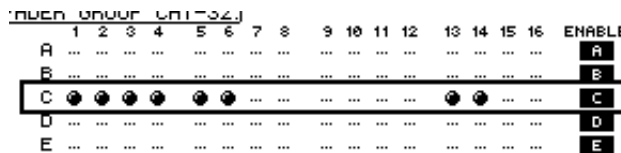

**Tip:**

- If you add one channel from a pair to a group, the pair partner is automatically added to the group.
- You can also select a channel on another layer by switching layers.

**4 In the same way, press the [SEL] button for other channels you wish to add to the group.**

The relative level of the faders for the grouped channels is determined by the position of the faders when the channels were added to the group.

The On/Off status of the grouped channels is determined by the [ON] button status when the channels were added to the group.

**5 To turn a group on or off, move the corresponding button in the ENABLE column, then press [ENTER].**

When the group Enable button is turned off, the corresponding group is temporarily cancelled.

**6 To use a fader group, operate one of the faders for the grouped channels.**

**Note:**

- If you wish to change the relative level balance between the grouped channels while this page is displayed, first turn off the Enable button or remove the channels for which you want to change the level from the group.
- If other pages are displayed, press and hold down the [SEL] button for the desired channels to temporarily remove them from the group, then change the level balance.

- 7 To use a mute group, press one of the [ON] buttons for the grouped channels.

All channels in the group switch their on/off status.

**Note:**

- While a mute group is enabled, you cannot turn a subset of the grouped channels on or off.
- If you wish to turn a subset of the grouped channels on or off, first turn off the Enable button, or remove the channels you wish to turn on or off from the group.

## Linking EQ and Compressor Parameters

Follow the steps below to link EQ or compressor parameters for Input Channels or Output Channels (Bus Outs 1–8, Aux Outs 1–8). This function enables you to set EQ or compressor parameters for multiple channels to the same values simultaneously.

- 1 Press the DISPLAY ACCESS [PAIR/GROUP] button repeatedly until one of the following pages appears.

- In EQ page

This page enables you to set EQ links (a–d) for Input Channels.

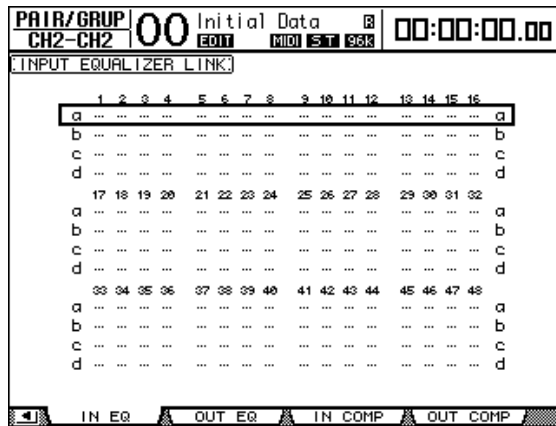

- Out EQ page

This page enables you to set EQ links (e–h) for Bus Outs (1–8) and Aux Outs (1–8).

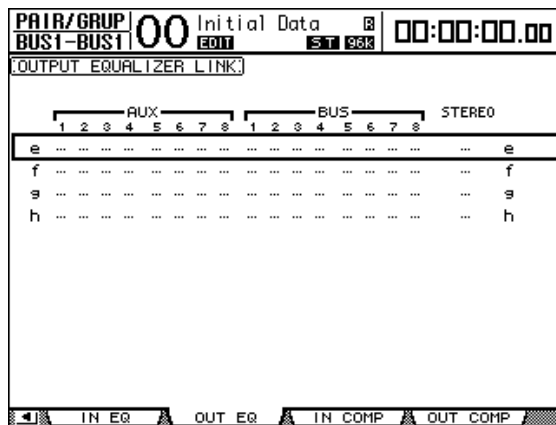



- **In Comp page**

This page enables you to set Compressor links (i-l) for Input Channels.

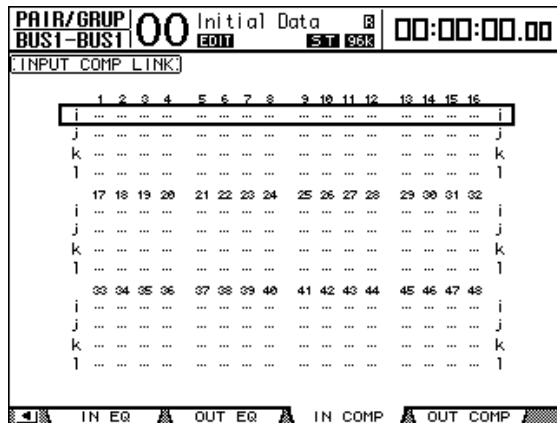

- **Out Comp page**

This page enables you to set Compressor links (m-p) for Bus Outs (1-8) and Aux Outs (1-8).

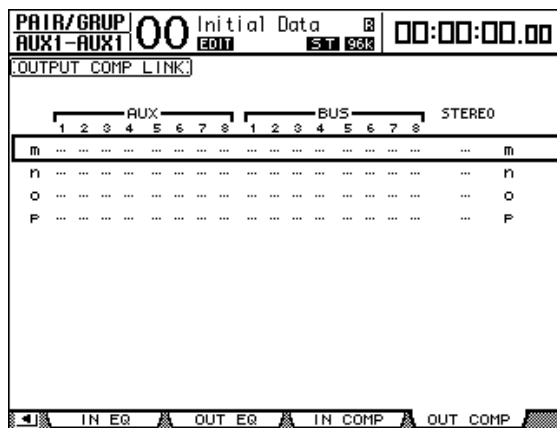

- 2 Press the up (▲) or down (▼) cursor button to select a link to which you want to add channels.

Example: EQ link C for Input Channels is selected.

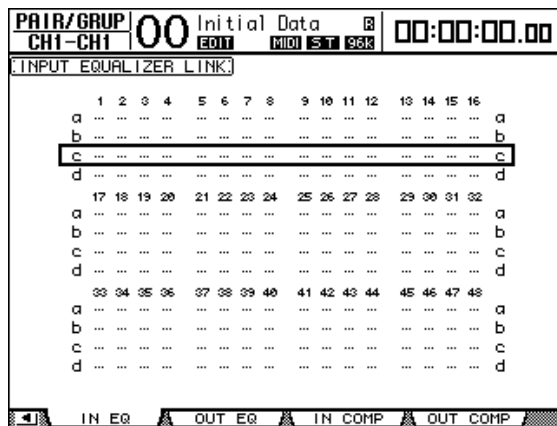

**3 Press the [SEL] button for a channel you wish to add to the EQ or Compressor link.**

The selected channel is marked with “●” and the channel is added to the link.

Example: Input Channels 1–4, 6, 9–10 and 14 have been added to EQ link C.

	1	2	3	4	5	6	7	8	9	10	11	12	13	14	15	16
a	...	...	...	...	...	...	...	...	...	...	...	...	...	...	...	...
b	...	...	...	...	...	...	...	...	...	...	...	...	...	...	...	...
<b>c</b>	●	●	●	●	...	●	...	...	●	●	...	...	...	●	...	...
d	...	...	...	...	...	...	...	...	...	...	...	...	...	...	...	...
	17	18	19	20	21	22	23	24	25	26	27	28	29	30	31	32
e	...	...	...	...	...	...	...	...	...	...	...	...	...	...	...	...

**Tip:**

- If you add one channel from a pair to a link, the pair partner is automatically added to the link.
- You can also select a channel on another layer by switching layers.

**4 In the same way, press the [SEL] button for other channels you wish to add to the link.**

The EQ or compressor settings for the first channel added to the link are applied to all subsequently-added channels.

**5 After all desired channels are added to the link, edit the EQ or compressor parameters for one of the linked channels.**

The edits for the EQ or compressor parameters are applied to the rest of the linked channels.

# 13 Internal Effects

This chapter describes how to use the DM1000's internal effects processors.

## About the Internal Effects

The DM1000 features four internal multi-effects processors that can be used via Aux Sends or by inserting them into specific channels.

These effects processors offer numerous types of effects, including **reverbs**, **delays**, **modulation-based effects**, **combination effects**, and **multi-channel effects** designed especially for use with surround sound.

Processor inputs and outputs can be patched to various sources. For example, effects processor inputs can be fed from the Aux Sends and output to Input Channels (effects send/return). Effects processors can also be inserted into Input Channels, Bus Outs, Aux Outs, or the Stereo Out.

**Effects processor 1** features eight assignable inputs and outputs, and creates 1-in/2-out, 2-in/2-out, or multi-channel surround effects.

**Effects processors 2 through 4** feature two assignable inputs and outputs, and create 1-in/2-out or 2-in/2-out effects.

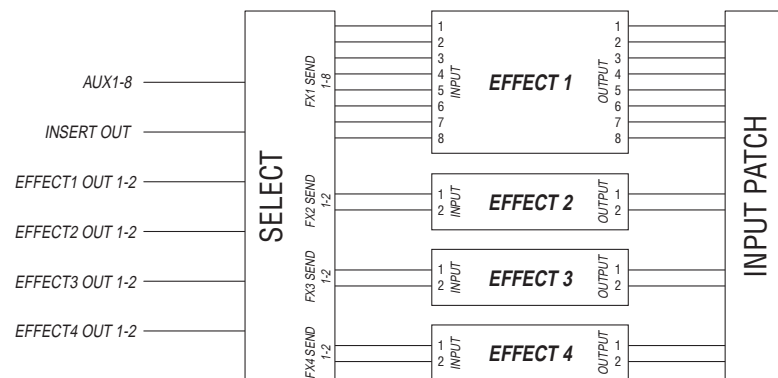

The DM1000 also features the Effects library, which contains 52 preset programs and 76 user programs.

## Using Effects Processors via Aux Sends

You can use effects processors via Aux Sends by patching effects processor inputs to Aux Outs, and effects processor outputs to Input Channels.

**1 Recall an effect program you wish to use.**

See page 169 for more information on recalling effect programs.

**2 Press the DISPLAY ACCESS [INPUT PATCH] button repeatedly until the In Patch | Effect page appears.**

This page enables you to patch all inputs and outputs of Effects processors 1–4.

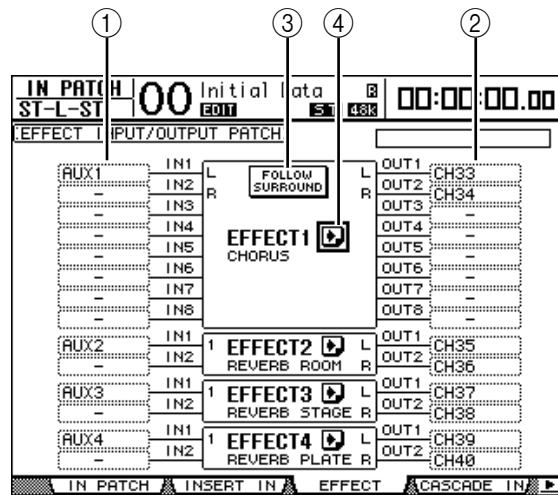

This page contains the following parameters:

- ① **IN**  
These parameter boxes select the signals to be fed to the effects processors.
- ② **OUT**  
These parameter boxes select the destination of the signals output from the effects processors.
- ③ **FOLLOW SURROUND**  
When surround effects (see page 153) are recalled to Effects processor 1, this button sorts the effect inputs and outputs displayed in the list according to the order specified on the Setup | Surr Bus page (see page 125).
- ④ **[EDIT] button**  
This button recalls the FX1 Edit–FX4 Edit pages, which enable you to adjust the effect parameters.

**3 To select a signal to be input to the effects processor, move the cursor to the desired In parameter box, rotate the Parameter wheel to select a signal from the following options, then press [ENTER].**

- – ..... No assignment
- AUX1–8 ..... Aux Outs 1–8
- INS CH1–48 ..... Input Channel 1–48 Insert Out
- INS BUS1–8 ..... Bus Out 1–8 Insert Out
- INS AUX1–8 ..... Aux Out 1–8 Insert Out
- INS ST-L & INS ST-R .. Stereo Out L & R Insert Out

- **FX1-1–FX4-2** .....Other effects processor outputs  
You cannot select outputs FX1–3 to FX1–8. In addition, you cannot select the output of the effects processor you are currently using.

To use the internal effects processors via Aux Sends, select Aux 1–8 (in most cases). You can patch a different signal to the other input of 2-in/2-out effect programs.

**Tip:**

- You can patch a signal to multiple effect inputs.
- Move the cursor to an IN parameter box and press the [ENTER] button. The Patch Select window appears. This window enables you to select the input source quickly.

**4 To patch a signal output from the effects processor, move the cursor to the desired OUT parameter box, rotate the Parameter wheel to select the signal destination from the following options, then press [ENTER].**

- – .....No assignment
- **CH1–48** .....Input Channels 1–48
- **INS CH1–48**.....Input Channel Insert In
- **INS BUS1–8** .....Bus Out 1–8 Insert In
- **INS AUX1–8**.....Aux Out 1–8 Insert In
- **INS ST-L & INS ST-R**...Stereo Out Insert In
- **FX1-1–FX4-2** .....Other effects processor inputs  
You cannot select the input of the effects processor you are currently using.

To use the internal effects processors via Aux Sends, select CH 1–48 (in most cases). The channels you assign here will become the effects return channels. You can patch a different channel to the other output of a 1-in/2-out or 2-in/2-out effect program to create stereo effects.

**Tip:**

- You can also use the Patch Select window to set the OUT parameter boxes, as explained in Step 3.
- The number of inputs and outputs available for each effect varies depending on the type of effect programs initially recalled.

**Note:** You cannot select a channel as the destination of multiple effect signals. If you select a channel that is already selected in another OUT parameter box, that OUT parameter box switches its indicator to “–” (not assigned).

**5 Adjust the level of Aux Sends patched to the effects processor.**

Refer to chapter 8 “Aux Sends” on page 91 for information on setting the Aux Sends.

**Note:** Do not raise the level of the Aux Sends (patched to the effects processor) on the effects return channels. Otherwise, the signal will return to the same channel, causing a signal loop and possibly damaging your speakers.

**Tip:** Use the Master layer fader to adjust the final Aux Send output level. At this time, you can view the level on the Meter | Master page (see page 37).

**6 Adjust the level, pan, and EQ of the Input Channels patched to the effect outputs.**

**Tip:** To mix the effects sound returned via the Aux Sends with the original dry sound, set the effect’s MIX BALANCE parameter to 100% (only the effects sound will be output).

## Inserting the Internal Effects into Channels

You can insert the internal effects into certain Input Channels or Output Channels (Bus Outs 1–8, Aux Outs 1–8, Stereo Out).

**Note:** If effects are inserted in channels, you cannot use those effects via Aux Sends or insert them into other channels.

- 1 Select an internal Effects processor (1–4), then recall the desired effect programs.
- 2 Press the [SEL] button or move the fader of the Input Channel or Output Channel into which you want to insert the selected effects.

**Tip:** Repeatedly pressing the STEREO [SEL] button toggles between the left and right Stereo Out channels.

- 3 Press the DISPLAY ACCESS [ $\phi$ /INSERT/DELAY] button repeatedly until the  $\phi$ /Ins/Dly | Insert page appears.

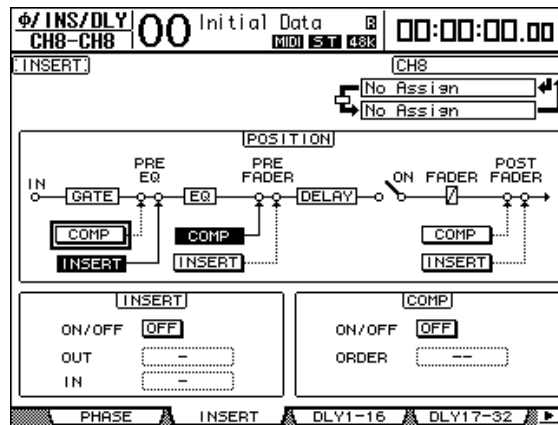

- 4 Select the effect insertion position using the INSERT button in the POSITION section.
- 5 Move the cursor to the OUT parameter box in the INSERT section, then select the inputs of the effects processor selected in Step 1.
  - FX1-1 through FX1-8 . Inputs 1–8 of Internal Effects Processor 1
  - FX2-1 & FX2-2 ..... Inputs 1 & 2 of Internal Effects Processor 2
  - FX3-1 & FX3-2 ..... Inputs 1 & 2 of Internal Effects Processor 3
  - FX4-1 & FX4-2 ..... Inputs 1 & 2 of Internal Effects Processor 4
- 6 Press [ENTER] to confirm the setting.
- 7 Move the cursor to the IN parameter box in the INSERT section, select the outputs of the effects processor selected in Step 5 and 6, then press [ENTER] to confirm the setting.
- 8 Move the cursor to the ON/OFF button in the INSERT section, then press [ENTER] to turn on the button.

Effect insertion is now enabled.

**Tip:**

- After inserting effects to channels, adjust the MIX BALANCE parameter for the effects, according to the purpose and effects type.
- Move the cursor to an empty IN or OUT parameter box and press the [ENTER] button. The Patch Select window appears, which enables you to quickly select available signal paths.

## Editing Effects

To edit effect programs recalled to the internal Effects processors 1–4, press the DISPLAY ACCESS [EFFECT] button repeatedly until the Edit page for the effects processor you wish to edit appears.

Effects processors 1–4 correspond to the following pages:

- **Effects Processor 1**.....FX1 Edit page
- **Effects Processor 2**.....FX2 Edit page
- **Effects Processor 3**.....FX3 Edit page
- **Effects Processor 4**.....FX4 Edit page

These Edit pages contain the following effect parameters.

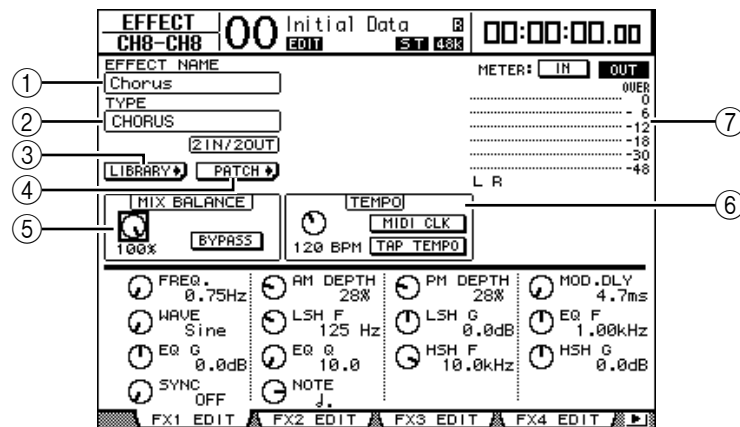

### ① EFFECT NAME

This parameter displays the name of the effect program currently used by the effects processor.

### ② TYPE

This parameter displays the type of effect program currently used by the effects processor. The I/O configuration of the effect program is displayed below this parameter.

### ③ **LIBRARY** button

Move the cursor to this parameter, then press [ENTER] to display the Library page for the selected effects processor.

### ④ **PATCH** button

Move the cursor to this button, then press [ENTER] to display the In Patch | Effect page, which enables you to assign signals to the inputs and outputs of Effects processors 1–4.

### ⑤ MIX BALANCE

This parameter knob enables you to set the balance between wet and dry signals. When the parameter is set to 0%, only the dry signal is heard. When set to 100%, only the wet signal is heard. Turn on the BYPASS button to bypass the currently-selected effects processor.

### ⑥ TEMPO

This section displays the parameters that appear only when a delay effect type or a modulation-based effect type is selected. These TEMPO parameters calculate and set the delay time for delay effects, or the modulation frequency for modulation effects, relative to the specified tempo and note length. Use these parameters along with the SYNC or NOTE parameter located at the bottom of the display page.

When you turn on the SYNC parameter, the DM1000 recalculates the delay time or modulation frequency based on the TEMPO parameter value (tempo) and the NOTE parameter value (note). For example, if the TEMPO parameter is set to 120BPM and the NOTE parameter is set to one eighth note, turning on the SYNC parameter sets the delay time to 250 msec and the modulation frequency to 0.25 Hz.

**Tip:**

- *If you turn on the SYNC parameter and edit the TEMPO or NOTE parameter, the DM1000 recalculates the delay time or modulation frequency.*
- *If you turn on the SYNC parameter and edit the delay time or modulation frequency, the NOTE parameter value changes based on the TEMPO parameter setting.*

- **TEMPO** ..... This parameter control sets the TEMPO parameter value in BPM.
- **MIDI CLK**..... Turning on the MIDI CLK by moving the cursor to this button and pressing [ENTER] updates the TEMPO data based on the MIDI Clock information received at the specified MIDI Rx port. (The TEMPO data is not updated if the MIDI Clock tempo is outside the range of 25 to 300 BPM.)
- **TAP TEMPO**..... You can also specify the tempo by moving the cursor to this button and double-clicking the [ENTER] button. The DM1000 calculates the tempo based on the time interval between your two taps (clicks) on the [ENTER] button. (The TEMPO data is not updated if the tap tempo is outside the range of 25 to 300 BPM.)

**Tip:** *If the Freeze effect is selected, the TEMPO section displays the record and playback buttons for using the effect, the recording data condition, and a progress bar that indicates the current status.*

⑦ **Meters**

These meters indicate the input or output levels of the currently-selected effects processor. Select the IN button or OUT button to display the input levels or output levels respectively. There are eight meters when Effects processor 1 is selected; two when Effects processors 2–4 are selected.

**Tip:** *You can also view the input and output levels of the effects processors on the Meter | Effect 1–4 pages (see page 37).*

Move the cursor to a parameter you wish to change, and rotate the Parameter wheel or press the [INC]/[DEC] buttons to adjust the setting. You can store the edited settings as a new program in the Effects library (see page 169).

**Note:** *You cannot change the effects type on this page. To change the effects type, recall a program that uses the desired effects type from the Effects library.*



## About Surround Effects

The effects types available for Effects processor 1 include surround effects that support 5.1-channel (AUTO PAN 5.1, CHORUS 5.1, etc.). Surround effects are multi-channel effects that feature up to six inputs and six outputs, and enable you to create the effect of the sound image moving or circling back and forth and left to right, and to process up to six channel input signals simultaneously.

**Note:**

- Only Effects processor 1 enables you to recall Surround effects settings.
- Recalling certain surround effects into Effects processor 1 will disable Effects processors 2–4.

The DM1000 Surround mode setting does not affect the surround effects. For example, even if the DM1000 is in Stereo Surround mode, you can recall a surround effect program and use its 6-channel inputs and outputs. However, to monitor the effect signals correctly, you must patch the effect outputs to Input Channels and monitor the signals using the Surround Monitor function (see page 131).

## About Plug-Ins

If you installed a mini-YGDAI card that supports the Effects function into Slot 1 or 2, you can use plug-in effects in addition to the internal effects processors.

You can patch Bus signals or channel insert outs to the plug-in input. The plug-in output can be patched to Input Channels or channel insert ins.

To use the plug-in effects, press the [EFFECT] button repeatedly until the Effect | P-IN Edit1 or P-IN Edit 2 page appears. If you installed a mini-YGDAI card in Slot 1, use the P-IN Edit1 page to set the plug-in. If you installed the card in Slot 2, use the P-IN Edit2 page.

For details on using plug-ins, refer to the owner’s manual that came with the plug-in card.

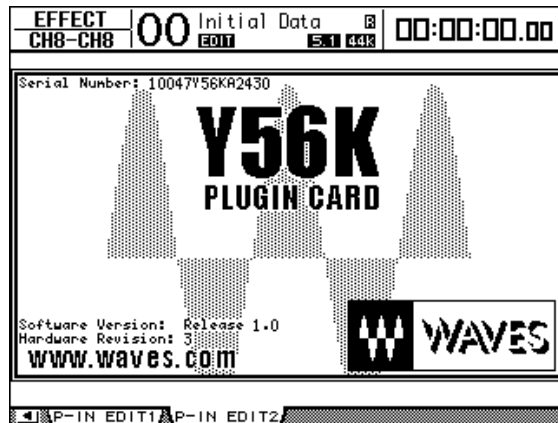

As of February 2003, the DM1000 supports the following plug-in cards. Visit the Yamaha web site for the latest information on compatible plug-in cards.

- Waves..... Y56K



# 14 Scene Memories

This chapter describes Scene memories, which store DM1000 mix and effects settings.

## About Scene Memories

Scene memories enable you to store a snapshot of DM1000 channel mix settings and internal effects processor settings as a “Scene” in a special memory area.

There are 99 Scene memories, and you can recall any Scene using the display pages or the controls on the top panel.

**Tip:**

- You can also recall Scenes by replaying Automixes (see page 181) or by transmitting Program Changes from external MIDI devices (see page 239).
- You can back up Scene memories to external MIDI devices by using MIDI Bulk Dump (see page 246).

## What is Stored in a Scene?

The following parameter settings are stored in a Scene:

Scene	Parameters
<b>Mix parameters</b>	All channel faders
	Channel to Aux Out 1–8 Send levels
	Aux Out 1–8 & Bus Out 1–8 levels
	All channel [ON] button settings
	All channel Phase & Delay settings
	All channel Attenuator settings
	All channel Compressor settings
	Input Channel Gate settings
	All channel EQ settings
	All channel Pan settings
	All channel routings
	Fader groups, Mute groups, EQ links, and Compressor links
	All channel pair settings
<b>Effects parameters</b>	Effect programs recalled for Effects processors 1–4 and their parameter settings
<b>Remote Layer</b>	Fader, Encoder and [ON] button status (only when Remote Control Target is set to USER DEFINED)
<b>Scene settings</b>	Scene titles and Fade Time settings
<b>Input Patching</b>	Input Patch library numbers
<b>Output Patching</b>	Output Patch library numbers

**Note:**

- Scenes take a snapshot of Input and Output Patch library numbers that are in use at the time the Scene is stored, but exclude current (edited) Input and Output patching.
- If you do not store the edited Input and Output patching to the libraries, recalling a Scene may change the current patching.

## About Scene Numbers

Scene memories are numbered with #U or from #0 through #99. You can store Scenes in Scene memories #1–99. When you recall a Scene, the Scene memory number (Ud, 00–99) appears on the Scene memory display and at the top of the display page.

**Scene memory #0 (#00 on the Scene memory display) is a special read-only memory that contains the default settings of all mix parameters. To reset all mix parameters on the DM1000 to their initial or default values, recall Scene memory #0.**

Also, the Initial Data Nominal check box on the Setup | Prefer1 page (see page 250) enables you to specify whether Input Channel faders are set to either 0 dB or  $-\infty$  dB when Scene memory #0 is recalled.

**Scene memory #U (“Ud” on the Scene memory display) is a special read-only memory that contains the mix settings immediately before you most recently recalled or stored a Scene. To undo or redo Scene memory recall and store operations, recall Scene memory #U.**

When you adjust parameters after recalling a Scene, the Edit indicators appear (the dot in the Scene memory display and “EDIT” at the top of the display), indicating that the mix settings no longer match those of the Scene that was most recently recalled. The contents of the Edit Buffer (where the current mix settings are stored) are retained while the DM1000 is turned off. This allows the DM1000 to restore the edited mix settings when you turn on the power.

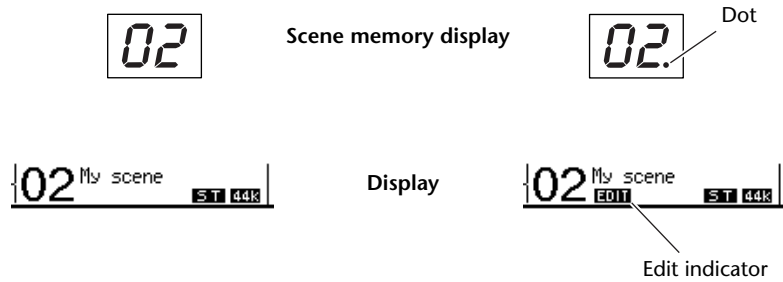

The contents of recalled Scene memory #2 match the current settings on the DM1000, and the Edit indicator remains off.

The parameters of recalled Scene memory #2 were edited. Therefore, the Edit indicators appear, indicating that the current settings on the DM1000 do not match Scene memory #2.

## Storing and Recalling Scenes

You can store and recall Scenes by pressing the buttons on the top panel or using the dedicated Scene memory page on the display.

**Note:**

- When you store Scenes, make sure that there are no settings in the Edit Buffer that you do not want to store. Make sure that no settings, especially faders, have been adjusted unintentionally.
- If you are not sure of the Edit Buffer's contents, recall the last Scene, make the adjustments you want, then store the Scene. You may wish to store the current Scene to an unused Scene memory, just in case.

### Storing and Recalling Scenes Using the SCENE MEMORY Buttons

You can use the SCENE MEMORY buttons to store and recall Scenes.

- 1 Adjust the mix parameters on the DM1000 to the conditions you wish to store as a Scene.**
- 2 Press the SCENE MEMORY Up [▲] or Down [▼] buttons to select a Scene memory number.**

If you select a Scene memory other than the currently-recalled Scene, its number flashes on the Scene memory display.

Scene memories #U (“Ud”) and #0 (“00”) are special read-only memories, to which you cannot store Scenes. Also, you cannot store Scenes to write-protected Scene memories (see page 158).

- 3 Press the SCENE MEMORY [STORE] button.**

The Title Edit window appears, which enables you to name the Scene to be stored.

**Tip:** You can disable this window by turning the Store Confirmation parameter to Off on the Utility | Prefer1 page (see page 250). In this case, the stored Scene will have the same name as the one recalled most-recently.

- 4 Enter the title, move the cursor to the OK button, then press [ENTER].**

The Title Edit window closes and the current Scene is stored to the selected Scene memory.

- 5 To recall a Scene, press the SCENE MEMORY Up [▲] or Down [▼] buttons to select a Scene memory number, then press the SCENE MEMORY [RECALL] button.**

**Tip:** If you turn the Recall Confirmation parameter to On on the Utility | Prefer1 page, a Scene recall confirmation window for Scene recalls appears before the Scene is recalled (see page 250).

## Storing and Recalling Scenes Using the Scene Memory Page

On the Scene Memory page, you can store, recall, write-protect, delete, and edit the titles of Scenes.

- 1 Adjust the mix parameters on the DM1000 to the conditions you wish to store as a Scene.
- 2 Press the DISPLAY ACCESS [SCENE] button repeatedly until the Scene | Scene page appears.

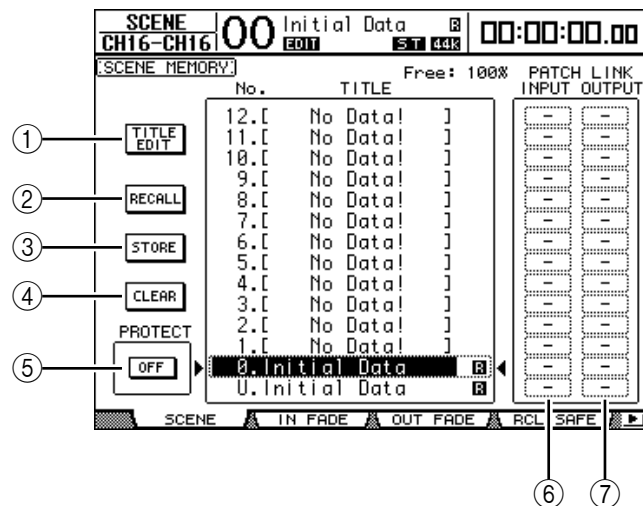

- 3 Rotate the Parameter wheel or press the [INC]/[DEC] buttons to select a Scene memory, move the cursor to one of the following buttons, then press [ENTER].

The stored Scene memory titles are displayed. The DM1000 displays the message “No Data!” for empty Scene memories.

- ① **TITLE EDIT**  
Select this button to display the Title Edit window, which enables you to edit a selected Scene title.
- ② **RECALL**  
This button recalls the contents of the selected Scene memory.
- ③ **STORE**  
This button stores the current Scene to the selected Scene memory. By default, a confirmation window appears before you store the Scene.
- ④ **CLEAR**  
This button deletes the contents of the selected Scene memory.
- ⑤ **PROTECT ON/OFF**  
This button switches on and off the write-protection of the contents of the selected Scene memory. A padlock icon (  ) appears next to the title of a Scene memory that is write-protected.
- ⑥ **PATCH LINK INPUT**  
These parameters indicate the Input Patch library numbers selected at the time the Scenes were stored. When you recall a Scene, the linked Input patch is recalled as well. You can also move the cursor to the parameter boxes and change the library numbers.

### ⑦ PATCH LINK OUTPUT

These parameters indicate the Output Patch library numbers selected at the time the Scenes were stored. When you recall a Scene, the linked Output patch is recalled as well. You can also move the cursor to the parameter boxes and change the library numbers.

## Auto Scene Memory Update

If the Scene MEM Auto Update check box on the Setup | Prefer1 page (see page 250) is turned on, parameter edits are stored automatically in a **Shadow memory**, which is available for each Scene. This is called the **Auto Update function**.

If the Auto Update function is enabled, parameter edits made after the Scene was recalled are stored in the Scene's Shadow memory. When you again recall the Scene, the contents of the Original and Shadow memories are recalled alternately.

Therefore, **even after you recall the Original Scene memory, you can recall the edited version from Shadow memory to restore the most recent edits.**

When recalling Original and Shadow memories, you can easily tell which is currently active by viewing the Edit indicators.

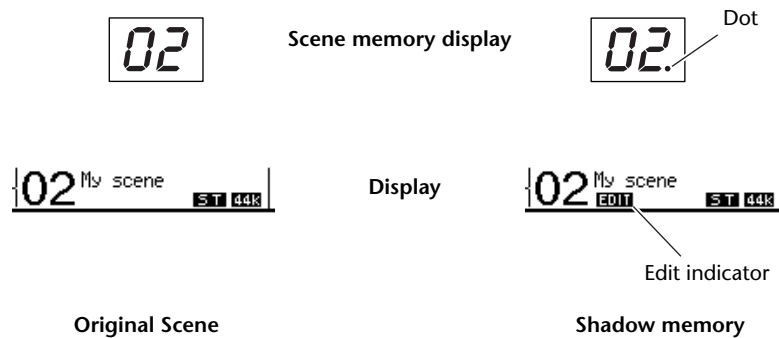

If a Shadow memory is recalled, the edited version is stored when you store the Scene. (The contents of the Original and Shadow memories then become identical.) When recalling Scenes in an Automix or via MIDI Program Change messages, the contents of the Original memory are always recalled, even if the Auto Update function is enabled.

## Fading Scenes

You can specify the time it takes the Input and Output Channel faders to move to their new positions when a Scene is recalled. This is called Fade Time, and it can be set for each channel in the range of 00.0 through 30.0 seconds (in 0.1 second steps). The Fade Time setting is stored in each Scene.

### Fading Input Channels

To set the Fade Time for Input Channels 1–48, press the DISPLAY ACCESS [SCENE] button repeatedly until the Scene | In Fade page appears. Move the cursor to the desired channel parameter box, then rotate the Parameter wheel or press the [INC]/[DEC] buttons to modify the Fade Time setting.

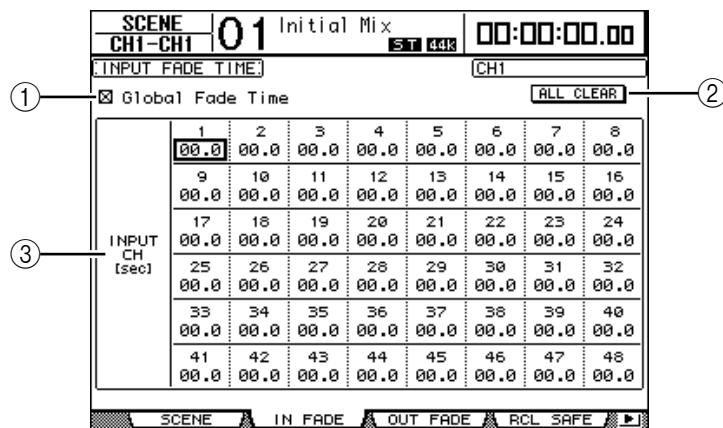

#### ① Global Fade Time

When this check box is checked, a Scene is recalled using the currently-specified Fade Time. (The Fade Time setting stored in the recalled Scene is temporarily ignored.) This check box setting works in unison with the Out Fade page.

#### ② ALL CLEAR

This button resets all channel Fade Times on the page to 00.0 second.

#### ③ INPUT CH1–48

These parameters enable you to set the Fade Time for each Input Channel in the range of 00.0 through 30.0 seconds. The Fade Time setting for one channel in a pair works in unison with its partner.

#### Tip:

- After you set the Fade Time, if you operate a certain fader while recalling a Scene, the fader's Fade Time setting is ignored.
- You can copy the currently-selected Input Channel Fade Time setting to all Input Channels by double-clicking the [ENTER] button. This is convenient when you wish to set the Fade Time for all channels simultaneously.



## Fading Output Channels

To set the Fade Time for the Output Channels (Stereo Out, Bus Outs 1–8, Aux Outs 1–8), press the DISPLAY ACCESS [SCENE] button repeatedly until the Scene | Out Fade page appears.

The basic operation is the same as on the In Fade page.

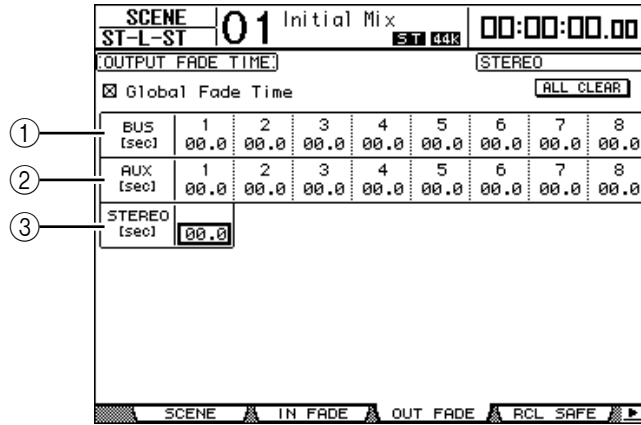

① **BUS1–8**

These parameters enable you to set the Fade Time for each Bus Out (1–8) in the range of 00.0 through 30.0 seconds.

② **AUX1–8**

These parameters enable you to set the Fade Time for Aux Outs 1–8.

③ **STEREO**

This parameter enables you to set the Fade Time for the Stereo Out.

**Tip:** You can copy the currently-selected Output Channel Fade Time setting to all Output Channels by double-clicking the [ENTER] button.

## Recalling Scenes Safely

When a Scene is recalled, all mix parameters are set accordingly. However, in some situations, **you can retain the current settings of certain parameters** on certain channels by using the **Recall Safe function**. Recall Safe settings are stored in Scene memories.

To set the Recall Safe function, press the DISPLAY ACCESS [SCENE] button repeatedly until the Scene | Rcl Safe page appears.

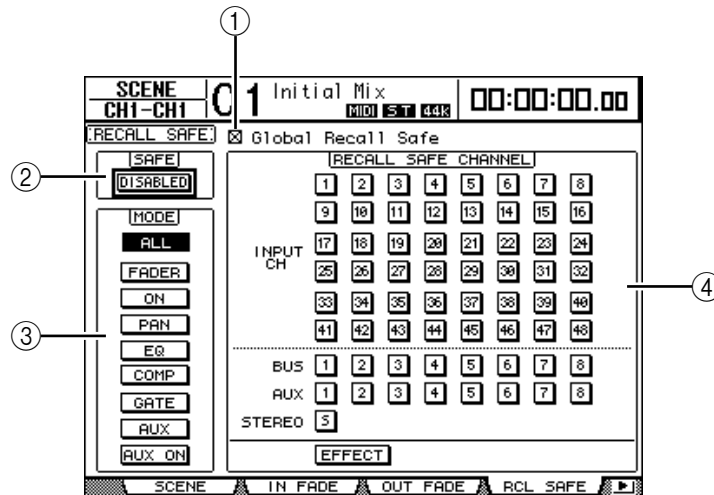

① **Global Recall Safe**

When this check box is checked, Recall Safe settings stored in Scene memories are ignored and the current settings are retained.

② **SAFE**

This parameter enables or disables the Recall Safe function.

③ **MODE**

The following MODE buttons determine which Safe channel parameters will remain unaffected by Scene recalls. The MODE buttons correspond to the following parameters:

- **ALL** ..... All parameters
- **FADER**..... Channel faders
- **ON**..... Channel On/Off parameters
- **PAN**..... Channel Pan parameters
- **EQ** ..... Channel EQ parameters
- **COMP**..... Channel Comp parameters
- **GATE** ..... Channel Gate parameters
- **AUX** ..... Channel Aux Send levels
- **AUX ON** ..... Aux Send On/Off parameters

**Tip:** The ALL button is mutually exclusive of the other buttons.

④ **RECALL SAFE CHANNEL section**

This section enables you to select which channels will remain unaffected by Scene recalls, including Input Channels 1–48, Bus Outs 1–8, Aux Outs 1–8, Stereo Out, internal effects processors. The Recall Safe function is effective on channels and effects for which the buttons are turned on.

## Sorting Scenes

You can sort Scenes in Scene memories.

- 1 Press the DISPLAY ACCESS [SCENE] button repeatedly until the Scene | Sort page appears.

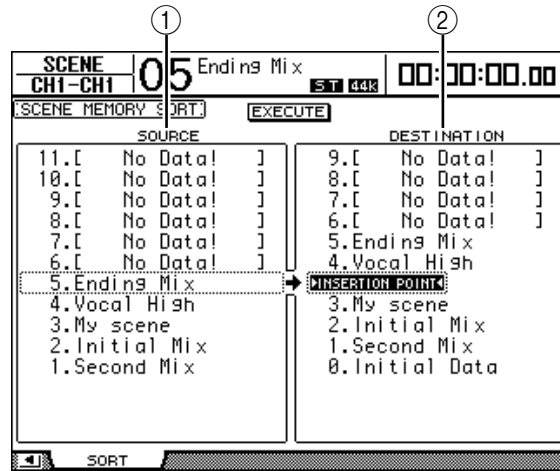

- 2 Move the cursor to the SOURCE list (①) in the left column, and rotate the Parameter wheel or press the [INC]/[DEC] buttons to select the Scene memory you wish to move.
- 3 Move the cursor to the DESTINATION list (②) in the right column, and rotate the Parameter wheel or press the [INC]/[DEC] buttons to select the position to which you want to move the source Scene memory.
- 4 Press [ENTER] to move the source Scene memory to the specified destination.

The Scene memory numbers are updated accordingly.



# 15 Libraries

This chapter describes the DM1000's various libraries.

## About the Libraries

The DM1000 features nine libraries that enable you to store Channel, Input Patch, Output Patch, Effects, and other data. You can also quickly recall this data from the libraries to restore previous parameter values.

The DM1000 offers the following libraries:

- Channel Library
- Input Patch Library
- Output Patch Library
- Effects Library
- Bus to Stereo Library
- Gate Library
- Compressor Library
- EQ Library
- Surround Monitor Library

**Tip:**

- You can store library data to a computer hard disk using the included Studio Manager software. Be sure to back up your important data.
- You can also store library data to an external MIDI device, such as a MIDI data flier, by using MIDI Bulk Dump (see page 246).

## General Library Operation

Most library functions are the same for each library.

### 1 Use the buttons on the top panel to locate the desired library pages.

The procedure for locating library pages varies depending on the library. Refer to the latter part of this chapter for more information on how to display the desired library page.

The example below assumes you have located the Input Patch library page.

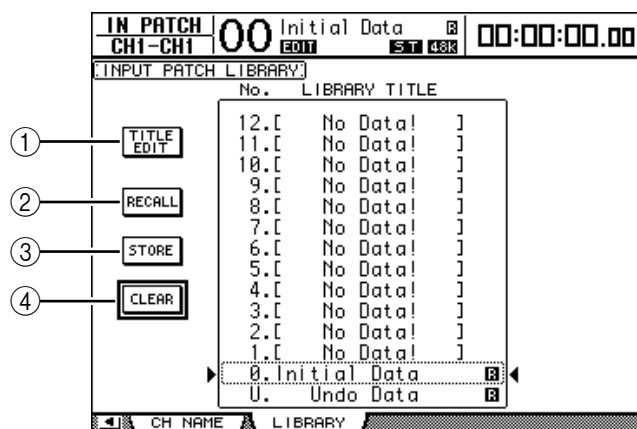

The library memory title list is displayed in the middle of the page. The message “No Data!” appears in the title column of empty library memories.

An “**R**” icon is displayed next to the name of read-only preset memories. You cannot store, clear, or edit the titles of these memories.

Memories #0 and #U are special read-only memories. Recall memory #0 to reset the parameter settings to their initial values. Recall #U to undo memory recall and store operations.

**2 Rotate the Parameter wheel or press the [INC]/[DEC] buttons to select the desired memory.**

The selected memory appears inside the dotted box.

**3 Move the cursor to one of the following function buttons, then press [ENTER].**

**① TITLE EDIT**

This button displays the Title Edit window, which enables you to edit the title of the selected memory. Move the cursor to the OK button, then press [ENTER] to confirm the edited title. See page 30 for more information on entering characters.

**② RECALL**

This button recalls the contents of the selected library memory. If you turn on the Recall Confirmation parameter on the Setup | Prefer1 page, the DM1000 displays a memory recall confirmation window.

**③ STORE**

This button stores the settings to the selected memory. Before you store the settings, you can enter or edit the title using the Title Edit window. See page 30 for more information on entering characters.

You can disable the Title Edit window by turning off the Store Confirmation parameter on the Setup | Prefer1 page. If you bypass the Edit Title window, the name “New Data” will be used as a title for the Scene memory.

**④ CLEAR**

This button deletes the contents of the selected memory. After you press [ENTER], the DM1000 displays a confirmation window. To execute the delete operation, move the cursor to the OK button in the confirmation window, then press [ENTER].

**Note:** *If you select a memory that already contains settings and execute the delete operation, the settings will be lost. Make sure that you do not accidentally delete important settings.*

## Using Libraries

### Channel Library

Channel library enables you to store and recall Input Channel and Output Channel parameter settings. The library contains two preset memories and 127 user (readable & writable) memories.

You can recall only the settings for the currently-selected channels from the Channel library. For example, you can recall Input Channel settings to Input Channels, but not to Bus Outs, Aux Sends, or Stereo Out, with the exception that memories #0 and #1 can be recalled to any channels.

Follow the steps below to use the Channel library.

#### 1 Press the DISPLAY ACCESS [VIEW] button, then press the [F3] button.

The View | Library page appears.

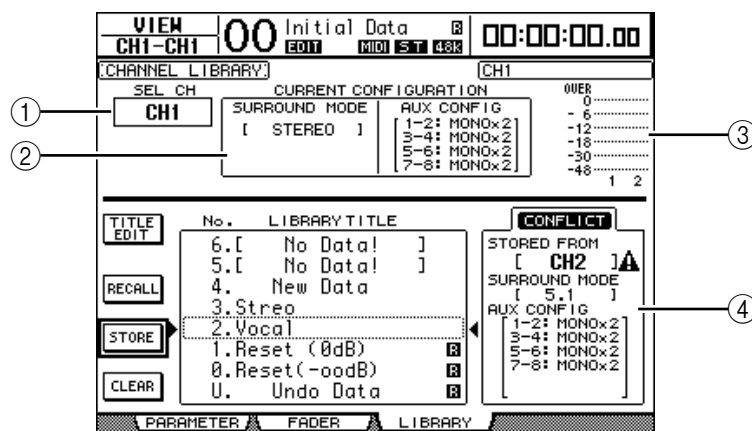

#### ① SEL CH

This parameter indicates the currently-selected channel.

#### ② CURRENT CONFIGURATION section

If the currently-selected channel is an Input Channel, its Surround mode and Aux configuration information is displayed here.

#### ③ Level meters

These meters indicate the levels of the currently-selected channel and the available partner.

#### ④ STORED FROM

This parameter indicates the channel for which the settings were originally stored in the selected library memory. If the currently-selected library memory contains Input Channel settings, its Surround mode and Aux pairing information are also displayed below this parameter.

#### 2 Use the LAYER buttons to select layers, then press the [SEL] buttons to select channels.

For details on the Store and Recall functions, see “General Library Operation” on page 165.

If the selected memory’s channel type does not match the type of the destination channel, an alarm mark (▲) and the word “CONFLICT” appear next to the STORED FROM parameter. These alarms indicate that you tried to recall unrecallable channel settings to the currently-selected channel.

The alarm indicators also appear when the Surround mode, Aux pair, and other non-channel parameter settings originally stored in the memory do not match those for the destination channel. However, if the channel type of the memory and that of the destination channel match, you can recall the settings even with the alarm indicators displayed. (For unmatched parameter settings, the DM1000 will use the settings in the memory that is to be recalled.)

The following preset memories are available for the Channel library.

No.	Preset Name	Description
0	Reset (−∞ dB)	This preset memory resets all parameters of the currently-selected channel to their initial values and sets the channel fader level to (−∞ dB).
1	Reset (0 dB)	This preset memory resets all parameters of the currently-selected channel to their initial values and sets the channel fader level to 0 dB (i.e., nominal).

### Input Patch Library

The Input Patch library enables you to store and recall all Input Patch settings. The library contains one preset memory and 32 user (readable & writable) memories.

To access the Input Patch library, press the DISPLAY ACCESS [INPUT PATCH] button repeatedly until the In Patch | Library page appears. For details on storing and recalling memories, see “General Library Operation” on page 165.

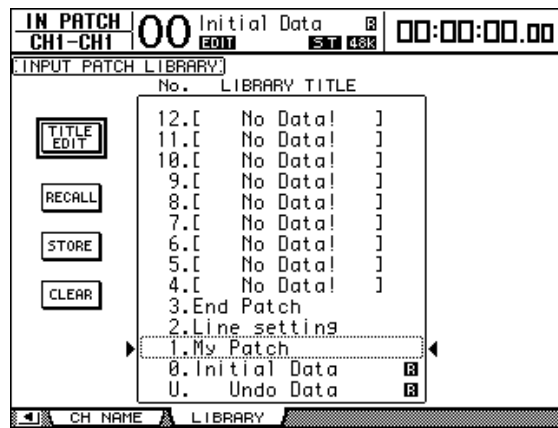

Input Patch preset memory #0 contains the following settings:

Input Channels 1–16	INPUT connectors 1–16
Input Channels 17–24	Channels 1–8 of Slot 1
Input Channels 25–32	Channels 1–8 of Slot 2
Input Channels 33–40	Internal Effects Processor 1–4 Outputs 1 & 2
Input Channels 41–44	2TRD1 & D2
Input Channels 45–48	OMNI IN connectors 1–4



## Output Patch Library

The Output Patch library enables you to store and recall all Output Patch settings. The library contains one preset memory and 32 user (readable & writable) memories.

To access the Output Patch library, press the DISPLAY ACCESS [OUTPUT PATCH] button repeatedly until the Out Patch | Library page appears.

For details on storing and recalling memories, see “General Library Operation” on page 165.

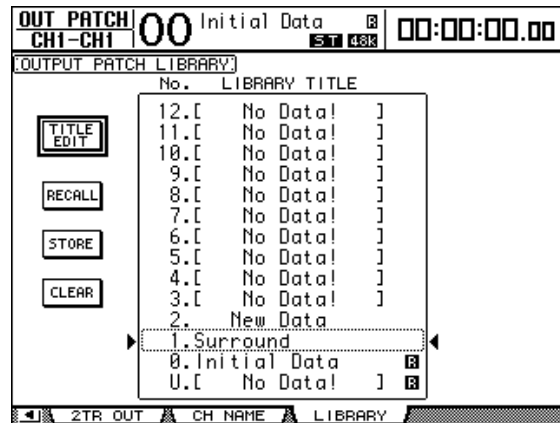

The Output Patch preset memory #0 contains the following settings:

OMNI OUT connectors 1–8	Aux Outs 1–8
OMNI OUT connectors 9–10	Stereo Out L & R
OMNI OUT connectors 11–12	Control Room Monitor L & R
Channels 1–8 of Slot 1	BUS1–BUS8
Channels 9–16 of Slot 1	BUS1–BUS8
Channels 1–8 of Slot 2	BUS1–BUS8
Channels 9–16 of Slot 2	BUS1–BUS8
2TR OUT DIGITAL1 (L)	Stereo Out L
2TR OUT DIGITAL1 (R)	Stereo Out R
2TR OUT DIGITAL2 (L)	Stereo Out L
2TR OUT DIGITAL2 (R)	Stereo Out R

## Effects Library

The Effects library enables you to store and recall Effects processor 1–4 programs. The library contains 52 preset programs and 76 user (readable & writable) programs.

**Note:**

- The Effects library is shared by Effects processors 1–4. However, only Effects processor 1 enables storing and recalling Surround effects settings.
- Certain effects type settings recalled to Effects processor 1 disable Effects processors 2–4.

To store and recall settings to and from the library, you must locate the corresponding Effects processor’s page.

To access the Effects library, press the DISPLAY ACCESS [EFFECT] button repeatedly until the library page for the desired Effects processor appears.

Each Effects processor features the library pages listed below:

- **Internal Effects Processor 1 Library** ..... FX1 Lib page
- **Internal Effects Processor 2 Library** ..... FX2 Lib page
- **Internal Effects Processor 3 Library** ..... FX3 Lib page
- **Internal Effects Processor 4 Library** ..... FX4 Lib page

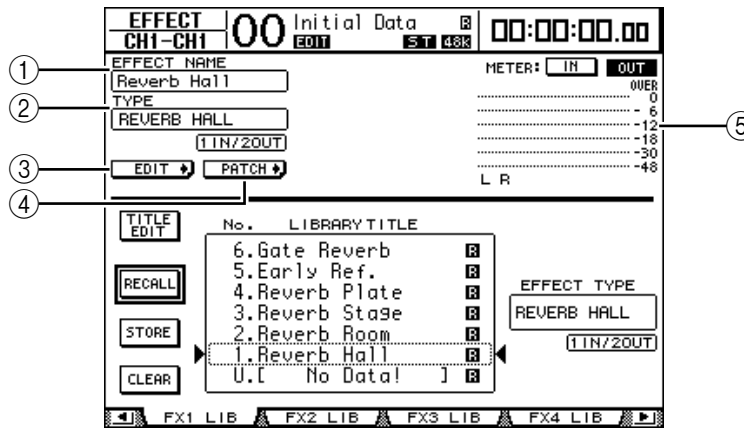

① **EFFECT NAME**

This parameter displays the name of the Effects program currently used by the Effects processor.

② **TYPE**

This parameter displays the effects type currently used by the Effects processor. The number of input and output channels for the currently-used effects appears below the TYPE parameter.

③ **EDIT**

Move the cursor to this button, then press [ENTER] to display the Effect | FX1 Edit, FX2 Edit, FX3 Edit, or FX4 Edit page to adjust the Effects parameters.

④ **PATCH**

Move the cursor to this button, then press [ENTER] to display the In Patch | Effect page to assign the input and output signals of Effects processors 1–4.

⑤ **Level meters**

These meters indicate the input or output levels of the currently-selected Effects processor. Select the IN button or OUT button to display the input levels or output levels respectively.

For details on storing and recalling programs, see “General Library Operation” on page 165.

The following tables list the preset effects programs in the Effects library:

• **Reverbs**

No.	Preset Name	Type	Description
1	Reverb Hall	REVERB HALL	Concert hall reverberation simulation with gate
2	Reverb Room	REVERB ROOM	Room reverberation simulation with gate
3	Reverb Stage	REVERB STAGE	Reverb designed for vocals, with gate
4	Reverb Plate	REVERB PLATE	Plate reverb simulation with gate
5	Early Ref.	EARLY REF.	Early reflections without the subsequent reverb
6	Gate Reverb	GATE REVERB	Gated early reflections
7	Reverse Gate	REVERSE GATE	Gated reverse early reflections

- **Delays**

No.	Preset Name	Type	Description
8	Mono Delay	MONO DELAY	Simple mono delay
9	Stereo Delay	STEREO DELAY	Simple stereo delay
10	Mod.delay	MOD.DELAY	Simple repeat delay with modulation
11	Delay LCR	DELAY LCR	3-tap (left, center, right) delay
12	Echo	ECHO	Stereo delay with crossed left/right feedback

- **Modulation-based Effects**

No.	Preset Name	Type	Description
13	Chorus	CHORUS	Chorus
14	Flange	FLANGE	Flanger
15	Symphonic	SYMPHONIC	Proprietary Yamaha effect that produces a richer and more complex modulation than normal chorus
16	Phaser	PHASER	16-stage stereo phase shifter
17	Auto Pan	AUTO PAN	Auto-panner
18	TREMOLO	TREMOLO	Tremolo
19	HQ.Pitch	HQ.PITCH	Mono pitch shifter, producing stable results
20	Dual Pitch	DUAL PITCH	Stereo pitch shifter
21	Rotary	ROTARY	Rotary speaker simulation
22	Ring Mod.	RING MOD.	Ring modulator
23	Mod.Filter	MOD.FILTER	Modulated filter

- **Guitar Effects**

No.	Preset Name	Type	Description
24	Distortion	DISTORTION	Distortion
25	Amp Simulate	AMP SIMULATE	Guitar amp simulation

- **Dynamic Effects**

No.	Preset Name	Type	Description
26	Dyna.Filter	DYNA.FILTER	Dynamically controlled filter
27	Dyna.Flange	DYNA.FLANGE	Dynamically controlled flanger
28	Dyna.Phaser	DYNA.PHASER	Dynamically controlled phase shifter

- **Combination Effects**

No.	Preset Name	Type	Description
29	Rev+Chorus	REV+CHORUS	Reverb and chorus in parallel
30	Rev->Chorus	REV->CHORUS	Reverb and chorus in series
31	Rev+Flange	REV+FLANGE	Reverb and flanger in parallel
32	Rev->Flange	REV->FLANGE	Reverb and flanger in series
33	Rev+Sympho.	REV+SYMPHO.	Reverb and symphonic in parallel
34	Rev->Sympho.	REV->SYMPHO.	Reverb and symphonic in series
35	Rev->Pan	REV->PAN	Reverb and auto-pan in series
36	Delay+ER.	DELAY+ER.	Delay and early reflections in parallel
37	Delay->ER.	DELAY->ER.	Delay and early reflections in series
38	Delay+Rev	DELAY+REV	Delay and reverb in parallel
39	Delay->Rev	DELAY->REV	Delay and reverb in series
40	Dist->Delay	DIST->DELAY	Distortion and delay in series

- Others

No.	Preset Name	Type	Description
41	<b>Multi.Filter</b>	MULTI.FILTER	3-band parallel filter (24 dB/octave)
42	<b>Freeze</b>	FREEZE	Simple sampler
43	<b>Stereo Reverb</b>	ST REVERB	Stereo reverb
44	<b>Reverb 5.1</b>	REVERB 5.1	6-channel reverb for 5.1 surround
45 <sup>1</sup>	<b>Octa Reverb</b>	OCTA REVERB <sup>2</sup>	8-channel reverb
46 <sup>1</sup>	<b>Auto Pan 5.1</b>	AUTO PAN 5.1	6-channel auto pan for 5.1 surround
47 <sup>1</sup>	<b>Chorus 5.1</b>	CHORUS 5.1	6-channel chorus for 5.1 surround
48 <sup>1</sup>	<b>Flange 5.1</b>	FLANGE 5.1	6-channel flanger for 5.1 surround
49 <sup>1</sup>	<b>Sympho. 5.1</b>	SYMPHO. 5.1	6-channel symphonic effect for 5.1 surround
50	<b>M. Band Dyna.</b>	M. BAND DYNA.	Multi-band dynamics processor
51 <sup>1</sup>	<b>Comp 5.1</b>	COMP 5.1 <sup>2</sup>	Multi-band compressor for 5.1 surround
52 <sup>1</sup>	<b>Compand 5.1</b>	COMPAND 5.1 <sup>2</sup>	Multi-band compander for 5.1 surround

1. These effects can be recalled only to Effects processor #1.
2. If these effects types are recalled to Effects processor #1, Effects processors #2 through #4 are disabled.

**Note:**

- Effects that include “5.1” in the names are multi-channel Surround effects that support 5.1 channels. These effects types are most effective when 6-channel outputs are connected to a 5.1-channel system.
- If REVERB 5.1, OCTA REVERB, COMP 5.1, or COMPAND 5.1 are recalled to Effects processor #1, Effects processors #2 through #4 are disabled.

## Bus to Stereo Library

You can store Bus to Stereo settings (levels and panpots of signals routed from Bus Outs 1–8 to the Stereo Bus). The library contains one preset memory and 32 user (readable & writable) memories.

To access the Bus to Stereo library, press the SELECTED CHANNEL [DISPLAY] button repeatedly until the Routing | Library page appears.

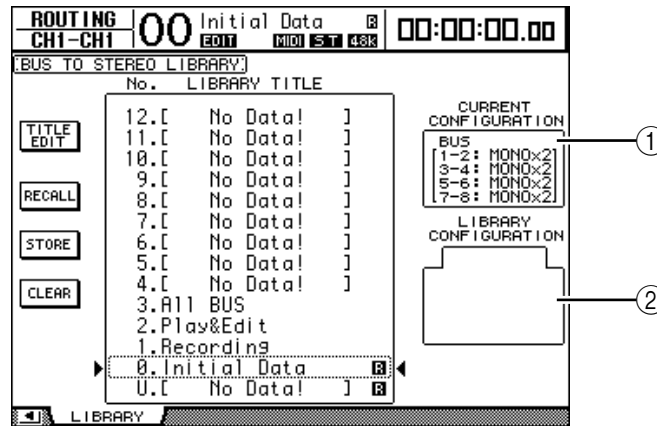

### ① CURRENT CONFIGURATION section

Bus Out (1–8) pairing information for the current configuration is displayed here.

**Note:** You can recall only Bus to Stereo library memories that have the same Bus Out (1–8) pairing configuration as the current configuration.

### ② LIBRARY CONFIGURATION box

Bus Out pairing information for the configuration stored in the currently-selected memory is displayed here. When the current configuration and the configuration in the selected memory do not match, the word “CONFLICT” appears in the LIBRARY CONFIGURATION box, although you can still recall the memory.

For details on storing and recalling memories, see “General Library Operation” on page 165.

## Gate Library

The Gate library enables you to store and recall Input Channel gate settings. The library contains four preset memories and 124 user (readable & writable) memories.

Follow the steps below to use the Gate library.

**1 Press the DISPLAY ACCESS [DYNAMICS] button, then press the [F2] button.**

The Dynamics | Gate Lib page appears.

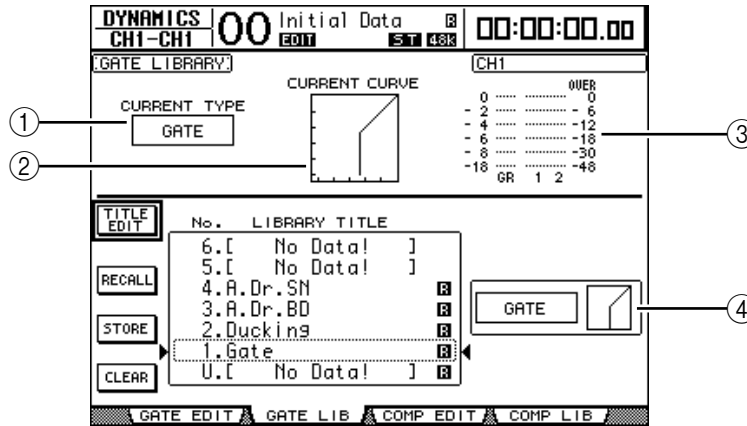

**① CURRENT TYPE**

This parameter displays the currently-selected channel gate type (Gate or Ducking).

**② CURRENT CURVE**

This graph displays the current channel gate curve.

**③ GR meters**

These meters indicate the amount of gain reduction being applied by the gate, and the post-gate levels of the currently-selected channel and its available pair partner.

**④ Type & Curve section**

The type (Gate or Ducking) and curve of the currently-selected memory is displayed here.

**Tip:** If you selected an Aux Out (1–8), Bus Out (1–8), or Stereo Out that does not feature a gate, the DM1000 indicates “XXX HAS NO GATE!” (in which XXX represents a signal name).

**2 Use the LAYER buttons to select layers, then press the [SEL] buttons to select channels.**

You can now store the selected channel gate settings or recall the gate library memories to channels. For details on storing and recalling memories, see “General Library Operation” on page 165.

The following table lists the preset memories in the Gate library:

No.	Preset Name	Type	Description
1	Gate	GATE	Gate template
2	Ducking	DUCKING	Ducking template
3	A. Dr. BD	GATE	Gate preset for use with acoustic bass drums
4	A. Dr. SN	GATE	Gate preset for use with acoustic snare drums

## Compressor Library

This library enables you to store and recall settings for the compressors on Input Channels, Bus Outs 1–8, Aux Outs 1–8, and Stereo Out. The library contains 36 preset memories and 92 user (readable & writable) memories.

Follow the steps below to use the Compressor library.

- 1 Press the **DISPLAY ACCESS [DYNAMICS]** button, then press the **[F4]** button. The Dynamics | Comp Lib page appears.

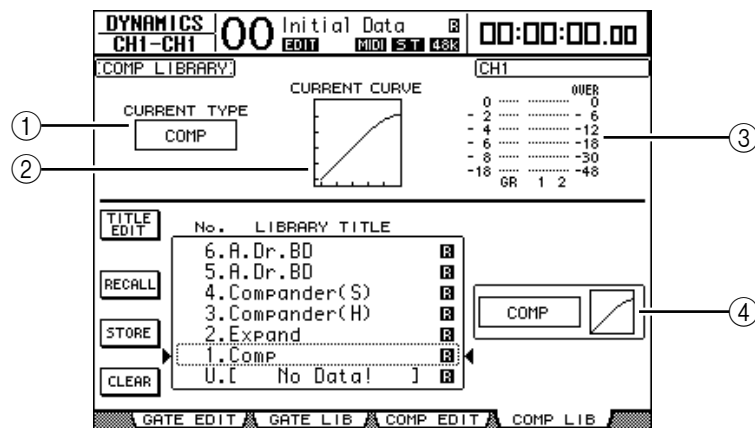

- 1 **CURRENT TYPE**

This parameter displays the currently-selected channel comp type (Compressor, Expander, Compander Soft, Compander Hard).

- 2 **CURRENT CURVE**

This graph displays the current compressor curve.

- 3 **GR meters**

These meters indicate the amount of gain reduction being applied by the compressor, and the post-comp levels of the currently-selected channel and its available pair partner.

- 4 **Type & Curve section**

The type and curve of the currently-selected memory is displayed here.

- 2 Use the **LAYER** buttons to select layers, then press the **[SEL]** buttons to select channels.

You can now store the selected channel comp settings and recall the compressor library memories to channels. For details on storing and recalling memories, see “General Library Operation” on page 165.

The following table lists the preset memories in the Compressor library:

No.	Preset Name	Type	Description
1	Comp	COMP	Compressor for reducing the overall volume level. Use it on the stereo output during mixdown, or with paired Input or Output Channels.
2	Expand	EXPAND	Expander template.
3	Compander (H)	COMPAND-H	Hard-kneed compressor template.
4	Compander (S)	COMPAND-S	Soft-kneed compressor template.
5	A. Dr. BD	COMP	Compressor for use with acoustic bass drum.
6	A. Dr. BD	COMPAND-H	Hard-kneed compander for use with acoustic bass drum.
7	A. Dr. SN	COMP	Compressor for use with acoustic snare drum.

No.	Preset Name	Type	Description
8	A. Dr. SN	EXPAND	Expander for use with acoustic snare drum.
9	A. Dr. SN	COMPAND-S	Soft-kneed compander for use with acoustic snare drum.
10	A. Dr. Tom	EXPAND	Expander for use with acoustic tom toms, which automatically reduces the volume when the tom toms are not played, improving mic separation.
11	A. Dr. OverTop	COMPAND-S	Soft-kneed compander for emphasizing the attack and ambience of cymbals recorded with overhead mics. It automatically reduces the volume when the cymbals are not played, improving mic separation.
12	E. B. Finger	COMP	Compressor for leveling the attack and volume of a finger-picked electric bass guitar.
13	E. B. Slap	COMP	Compressor for leveling the attack and volume of a slapped electric bass guitar.
14	Syn. Bass	COMP	Compressor for controlling or emphasizing the level of a synth bass.
15	Piano1	COMP	Compressor for brightening the tonal color of a piano.
16	Piano2	COMP	A variation on preset 15, using a deep threshold to change the overall attack and level.
17	E. Guitar	COMP	Compressor for electric guitar "cutting" or arpeggio-style backing. The sound color can be varied by playing different styles.
18	A. Guitar	COMP	Compressor for acoustic guitar "stroke" or arpeggio-style backing.
19	Strings1	COMP	Compressor for use with strings.
20	Strings2	COMP	A variation on preset 19, intended for violas or cellos.
21	Strings3	COMP	A variation on preset 20, intended for string instruments with a very low range, such as cellos or contra-bass.
22	BrassSection	COMP	Compressor for brass sounds with a fast and strong attack.
23	Syn. Pad	COMP	Compressor for musical instruments that feature gentle sounds which, depending on the tones, could diffuse, such as synth pad. Intended to prevent diffusion of the sound.
24	SamplingPerc	COMPAND-S	Compressor for making sampled percussion sound like real acoustic percussion.
25	Sampling BD	COMP	A variation on preset 24, intended for sampled bass drum sounds.
26	Sampling SN	COMP	A variation on preset 25, intended for sampled snare drum sounds.
27	Hip Comp	COMPAND-S	A variation on preset 26, intended for sampled loops and phrases.
28	Solo Vocal1	COMP	Compressor for use with main vocals.
29	Solo Vocal2	COMP	A variation on preset 28.
30	Chorus	COMP	A variation on preset 28, intended for choruses.
31	Click Erase	EXPAND	Expander for removing a click track that may bleed through from a musician's headphones.
32	Announcer	COMPAND-H	Hard-kneed compander for reducing the level of the music when an announcer speaks.
33	Limiter1	COMPAND-S	A soft-kneed compander with a slow release.
34	Limiter2	COMP	A "peak-stop" compressor.
35	Total Comp1	COMP	Compressor for reducing the overall volume level. Use it on the stereo output during mixdown, or with paired Input or Output Channels.
36	Total Comp2	COMP	A variation on preset 35, but with more compression.



## EQ Library

This library enables you to store and recall EQ settings for Input Channels, Bus Outs 1–8, Aux Outs 1–8, and Stereo Out. The library contains 40 preset memories and 160 user (readable & writable) memories.

Follow the steps below to use the EQ library.

- 1 Press the **SELECTED CHANNEL EQUALIZER [DISPLAY]** button repeatedly to display the EQ | EQ Library page.

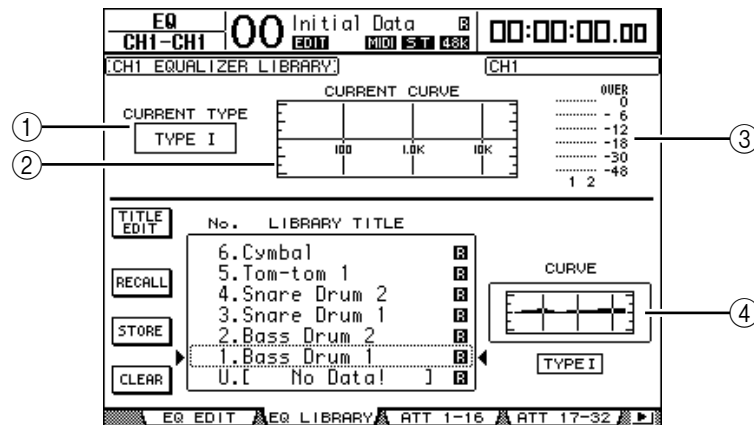

① **CURRENT TYPE**

This parameter displays the currently-selected channel EQ type (TYPE I or II).

② **CURRENT CURVE**

This graph displays the current EQ curve.

③ **Level meters**

These meters indicate the post-EQ levels of the currently-selected channel and its available pair partner.

④ **Type & Curve section**

The type and curve of the currently-selected EQ program are displayed here.

- 2 Use the **LAYER** buttons to select layers, then press the **[SEL]** buttons to select channels.

You can now store the selected channel EQ settings or recall the EQ library memories to channels. For details on storing and recalling memories, see “General Library Operation” on page 165.

The following table lists the preset memories in the EQ library:

No.	Preset Name	Description
1	<b>Bass Drum 1</b>	Emphasizes the low range of a bass drum and the attack created by the beater.
2	<b>Bass Drum 2</b>	Creates a peak around 80 Hz, producing a tight, stiff sound.
3	<b>Snare Drum 1</b>	Emphasizes “snappy” and rimshot sounds.
4	<b>Snare Drum 2</b>	Emphasizes various ranges for that classic rock snare drum sound.
5	<b>Tom-tom 1</b>	Emphasizes the attack of tom-toms, and creates a long, “leathery” decay.
6	<b>Cymbal</b>	Emphasizes the attack of crash cymbals, extending the “sparkling” decay.
7	<b>High Hat</b>	Use on a tight high-hat, emphasizing the mid to high range.
8	<b>Percussion</b>	Emphasizes attack and adds clarity to the high-range of instruments, such as shakers, cabasas, and congas.
9	<b>E. Bass 1</b>	Produces a tight electric bass sound by cutting very low frequencies.

No.	Preset Name	Description
10	<b>E. Bass 2</b>	Unlike preset 9, this preset emphasizes the low range of an electric bass.
11	<b>Syn. Bass 1</b>	Use on a synth bass with emphasized low range.
12	<b>Syn. Bass 2</b>	Emphasizes the attack that is peculiar to synth bass.
13	<b>Piano 1</b>	Makes pianos sound brighter.
14	<b>Piano 2</b>	Used in conjunction with a compressor, this preset emphasizes the attack and low range of pianos.
15	<b>E. G. Clean</b>	Use for line-level recording of an electric or semi-acoustic guitar to get a slightly harder sound.
16	<b>E. G. Crunch 1</b>	Adjusts the tonal quality of a slightly distorted guitar sound.
17	<b>E. G. Crunch 2</b>	A variation on preset 16.
18	<b>E. G. Dist. 1</b>	Makes a heavily distorted guitar sound clearer.
19	<b>E. G. Dist. 2</b>	A variation on preset 18.
20	<b>A. G. Stroke 1</b>	Emphasizes the bright tones of acoustic guitars.
21	<b>A. G. Stroke 2</b>	A variation on preset 20. You can also use it with an acoustic-electric nylon string guitar.
22	<b>A. G. Arpeg. 1</b>	Ideal for arpeggio playing on acoustic guitars.
23	<b>A. G. Arpeg. 2</b>	A variation on preset 22.
24	<b>Brass Sec.</b>	Use with trumpets, trombones, or saxes. When used with a single instrument, try adjusting the HIGH or HIGH-MID frequency.
25	<b>Male Vocal 1</b>	An EQ template for male vocals. Try adjusting the HIGH or HIGH-MID parameters according to the voice quality.
26	<b>Male Vocal 2</b>	A variation on preset 25.
27	<b>Female Vo. 1</b>	An EQ template for female vocals. Try adjusting the HIGH or HIGH-MID parameters according to the voice quality.
28	<b>Female Vo. 2</b>	A variation on preset 27.
29	<b>Chorus&amp;Harmo</b>	An EQ template for brightening choruses.
30	<b>Total EQ 1</b>	Use on a stereo mix during mixdown. Sounds even better when used with a compressor.
31	<b>Total EQ 2</b>	A variation on preset 30.
32	<b>Total EQ 3</b>	A variation on preset 30. Can also be used with paired Input or Output Channels.
33	<b>Bass Drum 3</b>	A variation on preset 1, with low and mid range reduced.
34	<b>Snare Drum 3</b>	A variation on preset 3, creating a thicker sound.
35	<b>Tom-tom 2</b>	A variation on preset 5, emphasizing the mid and high ranges.
36	<b>Piano 3</b>	A variation on preset 13.
37	<b>Piano Low</b>	Emphasizes the low range of pianos recorded in stereo.
38	<b>Piano High</b>	Emphasizes the high range of pianos recorded in stereo.
39	<b>Fine-EQ Cass</b>	Add clarity when recording to or from cassette tape.
40	<b>Narrator</b>	Ideal for recording narration.

## Surround Monitor Library

This library enables you to store and recall Surround Monitor settings. The library contains one preset memory that initializes the Surround Monitor settings, and 32 user (readable & writable) memories.

To access the Surround Monitor library, press the MONITOR [DISPLAY] button repeatedly until the Monitor | Surr Lib page appears. For details on storing and recalling memories, see “General Library Operation” on page 165.

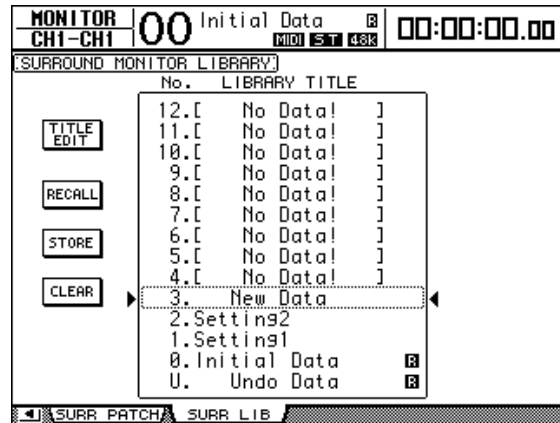



# 16 Automix

This chapter describes the Automix function, which automates real-time mix operation, and explains how to use it.

## About Automix

The DM1000 features an Automix function, which allows dynamic automation of virtually all mix parameters, including Levels, Mutes, Pan, Surround Pan, Aux Sends, Aux Send Mutes, EQ, and effects.

Various mixing events can be recorded in Automix. You can also punch channels or parameters in and out of recording on-the-fly, and edit most parameters off-line with 1/4 frame accuracy. Remote layer operations, and Scene and library recall operations can also be automated, which enables you to create mix automation that combines snap shots and dynamic mix parameter changes.

You can store up to 16 Automixes in the Automix library. You can also store an Automix or the entire Automix library to an external MIDI device, such as a MIDI data flier, by using MIDI Bulk Dump.

The following parameter events can be recorded in an Automix:

Parameters	Input Channels	Bus Out Master	Aux Send Master	Stereo Out
Channel levels (faders)	○	○	○	○
Channel mutes (ON/OFF)	○	○	○	○
Pan	○	—	—	—
Surround pan, LFE level, and DIV	○	—	—	—
EQ (F, Q, G, On/Off)	○	○	○	○
Aux Send 1–8 levels	○	—	—	—
Aux Send 1–8 mutes	○	—	—	—
Scene recalls				
EQ, Gate, Comp, Effects, Channel library recalls				
Effects parameters (certain parameters)				
User Defined Remote Layers (faders, [ON], Encoders)				

## Setting Up for Automix Recording

This section describes the procedure you must perform before you start Automix recording.

### Selecting the Timecode Source

Follow the steps below to select the timecode source and frame rate that the DM1000 uses for the Automix function.

- 1 Press the **DISPLAY ACCESS [SETUP]** button repeatedly until the **Setup | Time Ref** page appears.

This page enables you to select the timecode source for the Automix operation, and the port that receives the timecode.

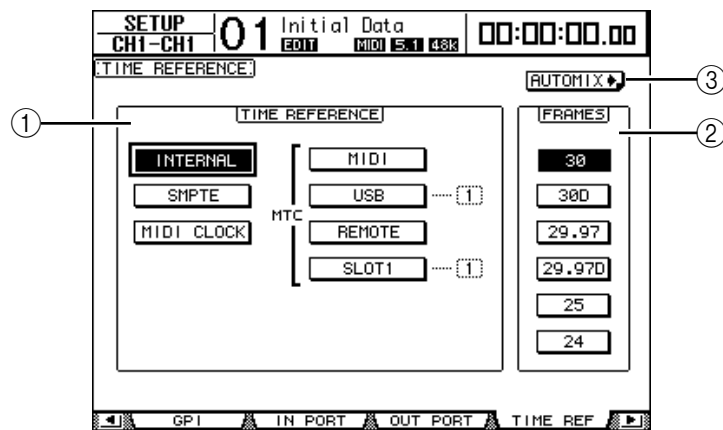

#### ① TIME REFERENCE section

Select one of the following timecode sources for the Automix operation.

- **INTERNAL** ..... Internally generated timecode
- **SMPTE** ..... SMPTE timecode received via the TIME CODE INPUT SMPTE connector
- **MIDI CLOCK**..... MIDI Clock received via the Rx PORT (specified on the Setup | MIDI/Host page)
- **MTC-MIDI** ..... MTC received via the MIDI IN port
- **MTC-USB** ..... MTC received via the USB port
- **MTC-REMOTE** ..... MTC received via the REMOTE connector
- **MTC-SLOT1** ..... MTC received via Slot 1 (for use with an optional MY8-mLAN card installed in Slot 1)

#### ② FRAMES

These parameter buttons select the SMPTE/MTC frame rate.

#### ③ **AUTOMIX** button

Move the cursor to this button, then press [ENTER]. The DM1000 quickly locates the Automix | Main page.

- 2 Move the cursor to the **TIME REFERENCE** section and select the desired timecode source.
- 3 If you selected **INTERNAL**, **SMPTE**, or **MTC** timecode, move the cursor to one of the **FRAMES** parameter buttons to select the desired frame rate.

If the DM1000 receives timecode with a frame rate that differs from the specified rate, the error message “Frame Mismatch!” appears. If you select the SMPTE timecode, the error message “Frame Jump!” may appear, depending on the selected frame rate.

- 4 If you select MIDI CLOCK, press the DISPLAY ACCESS [SETUP] button repeatedly until the Setup | MIDI/Host page appears (see page 236). Then, in the Rx PORT parameter box, specify the port or slot that receives MIDI Clock.

**Tip:**

- If you select the MIDI CLOCK source, Automix will respond to MIDI Start, Stop, and Continue messages.
- An Automix will play back correctly even if the frame rate differs from that used when the Automix was originally recorded. However, an Automix recorded using MIDI Clock and an Automix recorded using other timecode sources are not compatible with one another.

## Creating a Time Signature Map

If you selected the MIDI CLOCK source, you must specify the initial time signature and any time signature changes that follow, according to the song. (If you do not do this, the song timing and Automix position may not match when playback starts in mid-song.)

- 1 Press the DISPLAY ACCESS [SETUP] button repeatedly until the Setup | Time Sig page appears.

This page enables you to specify a measure number in the MEAS column and the time signature in the TIME column. By default, 4/4 is set in the first measure.

- 2 To change the initial time signature, move the cursor to the TIME value in the first measure, and use the Parameter wheel or [INC]/[DEC] buttons to select the desired time signature.
- 3 To insert a time signature change, specify the desired measure number in an empty box in the MEAS column, and specify the corresponding time signature in the TIME column.

To delete a time signature change, select it, then press [ENTER]. You cannot delete the initial time signature entry at measure #1.

## Recording an Automix

This section describes a general procedure for Automix recording, including creating a new Automix, as well as recording the fader, [ON] button, and other controller events real-time.

### Creating a New Automix

Follow the steps below to create a new Automix and select the parameters you want to record.

- 1 **Connect a timecode source to the DM1000.**
- 2 **Select the timecode source on the Setup | Time Ref page (see page 182).**  
If you selected MIDI CLOCK timecode, create a time signature map (see page 183).
- 3 **Press the DISPLAY ACCESS [AUTOMIX] button repeatedly until the Automix | Main page appears.**

This page enables you to set the basic Automix parameters, and record and play back Automixes.

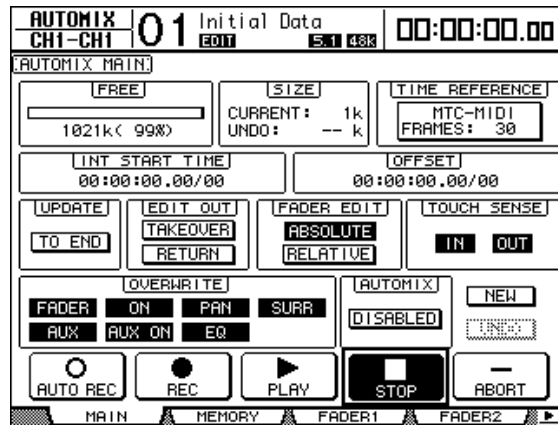

- 4 **Move the cursor to the NEW button located in the lower-right corner of the page, then press [ENTER].**

A confirmation window for creating a new Automix appears.



- 5 **Move the cursor to the YES button, then press [ENTER].**  
A new Automix is created.
- 6 **Move the cursor to the AUTOMIX DISABLED/ENABLED button, then press [ENTER] to switch it to ENABLED.**  
The new Automix is enabled.
- 7 **In the OVERWRITE section, select parameters you want to record.**

The seven buttons in the OVERWRITE section enable you to select parameters to be recorded in the Automix, including the following. See page 187 for more information.

- **FADER**..... Fader operation
- **ON**..... [ON] button on/off



- PAN .....Pan operation
- SURR .....Surround pan operation
- AUX.....Aux Send level operation
- AUX ON .....Aux Send on/off operation
- EQ.....EQ operation

## Recording the First Event

Follow the steps below to select channels and start Automix recording.

- 1 **Move the cursor to the REC button at the bottom of the page, then press [ENTER].**

The REC button flashes, indicating that the Automix is ready to record.

**Tip:** Alternatively, you could press the AUTO REC button (instead of the REC button), then press [ENTER] to place the Automix in record ready mode. Whether you press REC or AUTO REC will affect the way in which you cancel record ready mode.

- 2 **Press the [AUTO] button on the top panel.**

The button indicator lights up. If you turn on the [AUTO] button indicator while the REC button is lit or flashing on the Automix Main page, the [SEL] buttons will allow you to enable or disable the Automix function for each channel, or arm or disarm each channel.

Depending on the REC button status on the Main page, pressing the channel [SEL] buttons will place the corresponding channels in the following state:

- **When the REC button is flashing or lit:**

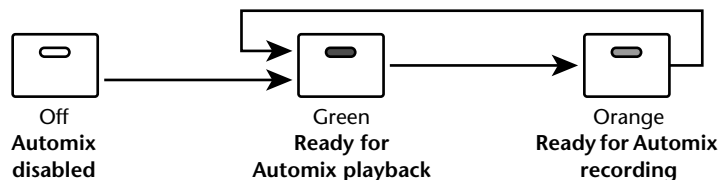
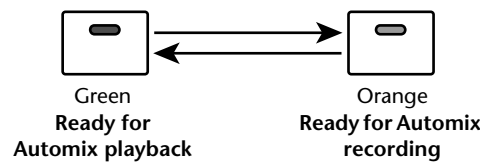

- **When the REC button is off:**

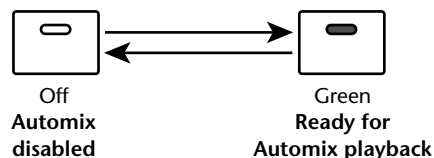

- 3 **Select the layer that contains the channels you wish to record, then press the corresponding channel [SEL] buttons.**

The button indicators light up orange. The corresponding channels are armed.

- 4 **Start the timecode source.**

The REC and PLAY buttons are highlighted and the recording starts. The [SEL] button indicators (illuminated in Step 3) change from orange to red (indicating that recording is in progress).

**5 Adjust the faders, Encoders, [ON] buttons, and other controls of the channels selected in Step 3.**

**Tip:** To punch channels out of recording, press the corresponding [SEL] buttons to change the button indicators from red to green.

**6 To record EQ events, use the SELECTED CHANNEL section to edit the EQ settings of the currently-selected channel.**

To select other channels, press the [AUTO] button to turn off the [AUTO] button indicator, then use the [SEL] buttons to select channels.

**Tip:** Scene and library recalls are always recorded, regardless of the selection in the OVERWRITE section and the [SEL] button status.

**7 To stop Automix recording, stop the timecode source, or move the cursor to the STOP button on the page, then press [ENTER].**

A confirmation message appears asking whether you want to update the existing Automix data (i.e., keep the edits just recorded).

Move the cursor to YES and press [ENTER] to update the data, or move the cursor to NO and press [ENTER] to discard the edits and return to the previous condition. Even after you update the existing Automix data, unless you proceed to the next recording, you can still restore the previous data by moving the cursor to the UNDO button on the Main page and pressing [ENTER].

**Tip:**

- When you stop Automix recording, all channels are disarmed, and the [SEL] button indicators light up green.
- If you use the AUTO REC button instead of the REC button in Step 1, the AUTO REC button will continue to flash after you stop Automix recording. In this way, you can resume recording when you restart the timecode source. To cancel record ready mode, move the cursor to the AUTO REC button, then press [ENTER].
- If the Mix Update Confirmation preference is off on the Setup | Prefer3 page, the confirmation window for updating the existing Automix data will not appear, and the edits just recorded will be retained.

**Note:**

- You can rerecord events as many times as you like. Remember, however, that unlike the first pass, on subsequent passes existing events for the currently-punched in parameter are overwritten.
- You can reduce the risk of overwriting important data by punching in and out only necessary parameters using the buttons in the OVERWRITE section.

## Parameter Recording

The following table summarizes the parameter recording operation for each parameter available in Automix recording.

Parameters	Channel	OVERWRITE	Operation	Pair/Group
Channel Levels (faders)	Input	FADER	Set Layer to Input, Fader mode to Fader, use faders	Faders of paired channels and grouped faders are recorded together.
	Bus Out, Aux Send		Set Layer to Master, Fader mode to Fader, use faders	
	Stereo Out		Use Stereo Out fader	
Channel Mutes (ON/OFF)	Input	ON	Set Layer to Input, use [ON] buttons	[ON] buttons of paired channels and grouped mutes are recorded together.
	Bus Out, Aux Send		Set Layer to Master, use [ON] buttons	
	Stereo Out		Use Stereo Out [ON] button	
Pan	Input	PAN	Set Layer to Input, Encoder mode to Pan, use Encoders. Use SELECTED CHANNEL section PAN control	If Pan mode is Gang or Inverse-Gang, paired channels are recorded together.
Surround Pan	Input	SURR	Use Joystick. If a surround parameter assigned to an Encoder, also use Encoders	If ST LINK button on Surround Edit page is on, adjacent partners are recorded together.
EQ (F, Q, G, On/Off)	Input, Bus Out, Aux Send, Stereo Out	EQ	Use SELECTED CHANNEL EQUALIZER section. (If EQ parameter assigned to an Encoder, also use Encoders.)	EQ of paired channels, and grouped EQs recorded together.
Aux Sends 1–8 Level	Input	AUX	If Fader mode is Aux, use faders. If Encoder mode is Aux, use Encoders (also use Aux Send or Aux View pages).	Aux send levels of paired channels recorded together. (If the selected Aux Send is paired, the send level to both Aux Sends is recorded.)
Aux Send 1–8 mutes	Input	AUX ON	Use Aux Send or Aux View pages	Aux send mutes of paired channels recorded together. (If the selected Aux Send is paired, mutes for both Aux Sends recorded.)
Scene recalls	—	—	Use SCENE MEMORY section or Scene Memory page	—
Library recalls	EQ, Gate, Comp, Effects, Channel	—	Use corresponding library page	—
Effects parameters (certain parameters)	Effects processors 1–4	—	Use corresponding page	—
User Defined Remote Layer	Faders	FADER	Select User Defined Remote Layer, use faders	—
	[ON] buttons	ON	Select User Defined Remote Layer, use [ON] buttons	—
	Encoders	PAN	Select User Defined Remote Layer, use Encoders	—

## Punching In & Out

You can modify part of a recorded Automix or add events to an Automix (Punch In & Out). You can punch in and out channels using the [SEL] buttons, or individual parameters using other controls.

### Punch In & Out Using the [SEL] Buttons

Follow the steps below to punch channels in and out using the [SEL] buttons.

- 1 Select parameters you wish to record in the OVERWRITE section.**
- 2 Move the cursor to the REC or AUTO REC button at the bottom of the page, then press [ENTER].**

- 3 Press the [AUTO] button.**

The button indicator lights up. At this time, make sure that the [SEL] button indicators for all channels (including the channels you want to punch in) are lit green.

- 4 Start the timecode source.**

The REC and PLAY buttons are highlighted and parameter event recording is armed. However, no events are yet recorded since no channels are selected.

- 5 To punch in channels, press the corresponding [SEL] buttons.**

The corresponding [SEL] button indicators light up red and the channels are placed in record mode.

***Note:** If the punch-in channels already contain the parameter events selected in the OVERWRITE section, punching-in immediately overwrites the existing events. Be careful while selecting parameters in the OVERWRITE section so that you will not delete events you wish to retain.*

- 6 Adjust the controls of the selected channels.**
- 7 To punch out the channels, press the corresponding [SEL] buttons again.**
- 8 Stop the Automix.**

A confirmation window regarding updating the Automix data appears.

***Tip:** You can also select the recording channels first using the [SEL] buttons, start the timecode source, then select the desired parameters in the OVERWRITE section to punch in and out.*

### Punching In & Out Individual Events

Even if you selected some parameters in the OVERWRITE section, you can punch in an individual parameter by following the steps below:

- 1 In the OVERWRITE section, select the parameters you want to record.**
- 2 Move the cursor to the REC or AUTO REC button at the bottom of the page, then press [ENTER].**

- 3 Press the [AUTO] button on the top panel.**

The button indicator lights up. Make sure that the [SEL] button indicators for all channels are lit green.

- 4 Start the timecode source.**

The REC and PLAY buttons are highlighted and event recording is armed. However, no events are yet recorded since no channels are selected.

**5 Perform the following operations to punch in and out individual events.**

Parameters	Channel	OVERWRITE	Operation	Punch In	Punch Out
<b>Channel Levels (faders)</b>	Input	FADER	Set Layer to Input, Fader mode to Fader	Touch fader knob and adjust <sup>1</sup>	Release fader knob <sup>2</sup>
	Bus Out, Aux Send		Set Layer to Master, Fader mode to fader		
	Stereo Out		Stereo Out fader		
<b>Pan</b>	Input	PAN	Set Layer to Input, Encoder mode to Pan	Press Encoder and adjust	Press Encoder
<b>Surround Pan</b>	Input	SURR	Select Input Layer and assign Surround LFE Level or Surround Pan Wheel to the Encoders	Press Encoder and adjust	Press Encoder
<b>EQ (F, Q, G)</b>	All channels	EQ	Use SELECTED CHANNEL EQUALIZER section. (If EQ parameter assigned to an Encoder, also use Encoders.)	Adjust SELECTED CHANNEL control <sup>3</sup>	Press [SEL] button
<b>EQ On/Off</b>				Press Encoder and adjust <sup>4</sup>	Press Encoder
<b>Aux Sends 1–8 Level</b>	Input	AUX	Set Layer to Input, Fader mode to Aux	Touch fader knob and adjust <sup>1</sup>	Release fader knob <sup>2</sup>
			Set Layer to Input, Encoder mode to Aux	Press Encoder and adjust	Press Encoder
<b>Effects parameters (certain parameters)</b>	Effects processors 1–4	—	Select internal effects processors	Move the cursor to the parameter control on the page, then press [ENTER].	Move the cursor to the parameter control on the page, then press [ENTER].
<b>User Defined Remote Layer</b>	Faders	FADER	Select User Defined Remote Layer	Touch fader knob and adjust <sup>1</sup>	Release fader knob <sup>2</sup>
	Encoders	PAN	Select User Defined Remote Layer	Press Encoder and adjust	Press Encoder

1. To punch in events by performing this operation, turn on the TOUCH SENSE IN button on the Fader1 or 2 page.
2. To punch out events by performing this operation, turn on the TOUCH SENSE OUT button on the Fader1 or 2 page.
3. To punch in events by performing this operation, turn on the Auto EQ Edit preference.
4. To punch in events by performing this operation, assign EQ parameters to the Encoders.

**6 Stop the Automix.**

A confirmation window regarding updating the Automix data appears.

## [SEL] Button Functions While the [AUTO] Button Indicator Is On

While the [AUTO] button indicator is lit, you can use the channel [SEL] buttons to turn the Automix function on and off, arm or disarm channels, or punch channels in and out.

The [SEL] button indicators operate as follows:

- **Off**..... Automix recording or playback disabled.
- **Green**..... Automix stopped or playing
- **Orange**..... The channel is armed.
- **Red**..... Automix recording in progress
- **Flashing red**..... Edit Out mode set to TAKEOVER, and fader events continue recording after punch out
- **Flashing green**..... Edit Out mode set to TAKEOVER, and faders are disabled after punch out

## Playing Back an Automix

As long as the Automix function is enabled, the Automix function will chase the incoming timecode and play and stop the current Automix accordingly.

You can stop playback manually by moving the cursor to the STOP or ABORT button on the Automix | Main/Memory page, then pressing [ENTER].

Playback will stop automatically if the DM1000 receives no timecode for a while, if the DM1000 receives MIDI Stop commands (only when the MIDI CLOCK source is selected), or if the end of the Automix data is reached.

While the [AUTO] button indicator is lit, the [SEL] button indicators light up green on the channel strips available for Automix playback. When Automix playback for an individual channel is disabled, its [SEL] button indicator turns off.

During playback, faders move in accordance with recorded fader events (as long as the corresponding layer and Fader mode is selected). You can disable fader movement by turning off the MOTOR button on the Fader 1 or 2 page (see page 196).

You can view fader events on the Fader 1 or 2 page (see page 196), and other events on the corresponding pages. Recorded events of the currently-selected channel are reflected in the SELECTED CHANNEL section controls and displays.

**Note:** *If the current effects type is different from that used when the effects parameter edits were recorded, the parameter edits will not be played back. However, they are not deleted. When you rerecord effects parameter edits from the beginning, it is recommended that you delete the existing effects events offline.*

## Automix Main Page

This section explains the Automix Main page. This page enables you to set the basic Automix parameters and record and play back Automixes. To locate the Automix | Main page, press the DISPLAY ACCESS [AUTOMIX] button repeatedly until the page appears.

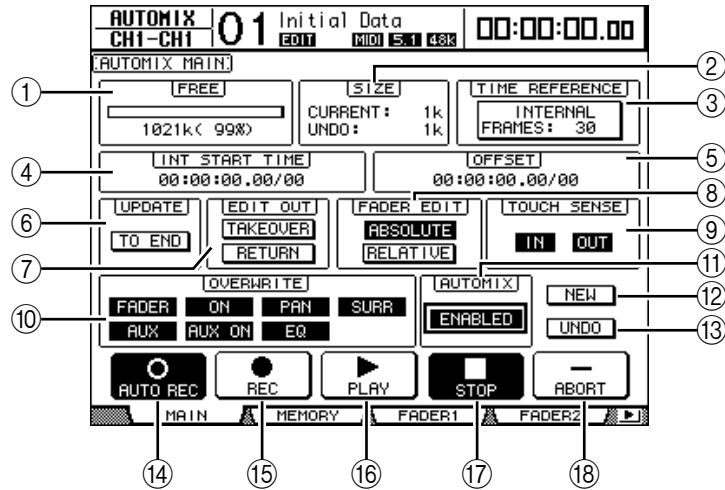

### ① FREE

The amount of free Automix memory remaining is displayed here in kilobytes, as a percentage, and by a bar graph.

### ② SIZE

The size of the current Automix and the size of any Automix data in the undo buffer are displayed here in kilobytes.

### ③ TIME REFERENCE

The timecode source and frame rate specified on the Time Ref page (see page 182) are also displayed here.

### ④ INT START TIME

This parameter sets the start time of the DM1000 internal timecode generator in hours, minutes, seconds, frames, and subframes. Move the cursor to a digit you wish to change, and rotate the Parameter wheel or press the [INC]/[DEC] buttons to modify the value. Press the [ENTER] button to reset the currently-selected digit to “00.”

### ⑤ OFFSET

This parameter specifies an offset relative to the external timecode source in hours, minutes, seconds, frames, and subframes. Specify a “+” value to move events forward relative to the incoming timecode. Specify a “-” value to move events backwards relative to the incoming timecode. Press the [ENTER] button to reset the currently-selected digit to “00.”

### ⑥ UPDATE

This button determines the fate of events that exist beyond the point at which rerecording is stopped.

When the TO END button is on, the DM1000 erases all events (that exist beyond the point at which rerecording is stopped) for parameters that have been edited during the current pass. This function is useful when you want parameters to remain the same right through to the end of the Automix.

When the TO END button is off, existing events are left as they are.

When the TO END button is on, the way in which fader events are processed depends on the currently-selected Fader Edit mode and Edit Out mode. The following table shows how the faders operate when the Fader Edit mode is set to Absolute.

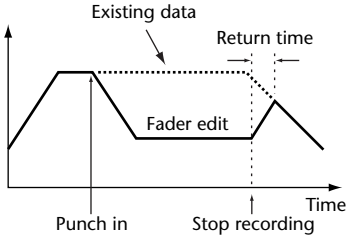
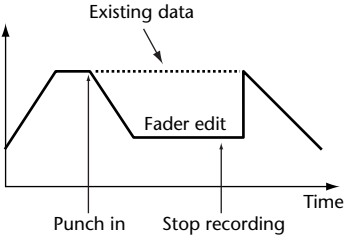
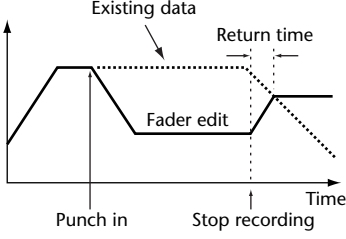
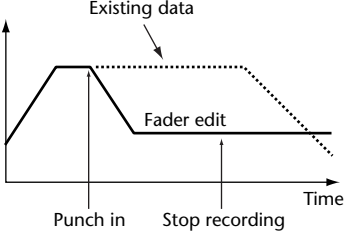
TO END	Return	Takeover or Off
OFF	<p>At the point at which recording is stopped, the fader returns to the position specified by the existing fader data, at the speed specified by the Time parameter on the Fader1 or 2 page.</p> 	<p>At the point at which recording is stopped, the fader remains at the same position until the next fader event in the existing data is encountered.</p> 
ON	<p>At the point at which recording is stopped, the fader returns to the position specified by the existing fader data, at the speed specified by the Time parameter on the Fader1 or 2 page. All subsequent events are erased. The fader remains at that position through to the end of the Automix.</p> 	<p>At the point at which recording is stopped, all subsequent events are erased so that the fader remains at that position right through to the end of the Automix.</p> 

If the Fader Edit mode is set to Relative, and the Edit Out mode is set to either Takeover or Off, the fader will remain at a position relative to its position when recording was stopped right through to the end of the Automix.

⑦ EDIT OUT

This parameter sets the Edit Out mode: TAKEOVER, RETURN, or OFF (both buttons are off). This mode determines how rerecorded fader moves align with existing fader data at the punch out point.

Fader data includes Input Channel levels, Bus Out master levels, Aux Send master levels, the Stereo Out level, and Remote layer faders.

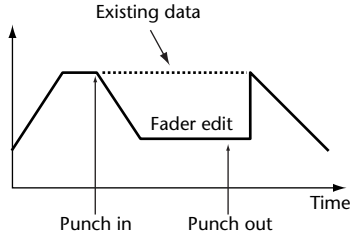
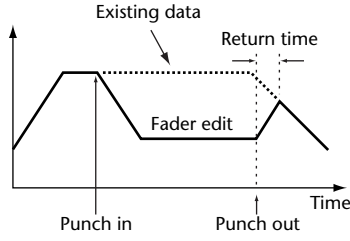
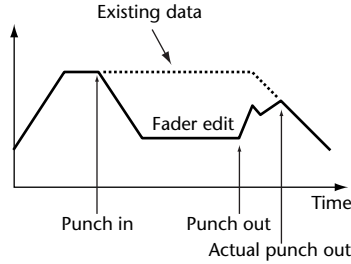

The following table shows how faders move in each Edit Out mode. You can set the Return Time (time required by Input and Output Channel faders to return to the previously-recorded position) on the Fader1 or 2 page (see page 196).

Off	Return	Takeover
<p>At the punch out point, the fader remains at the same position until the next fader event in the existing data occurs.</p> 	<p>At the punch out point, the fader returns to the position specified by the existing fader data, at the speed specified by the Time parameter on the Fader1 or 2 page.</p> 	<p>At the punch out point, recording continues until the fader position intersects the existing fader data. If you are still touching the fader knob at the actual punch out point, the fader is disabled until you release it.</p>  <p>In this example, punch out was performed by pressing the [AUTO] button, and the fader was moved manually between the specified punch out point and actual punch out point.</p>

**⑧ FADER EDIT**

This parameter determines how fader moves are rerecorded (it has no effect during the first recording pass). You can select ABSOLUTE or RELATIVE.

In Absolute mode, fader moves are rerecorded as absolute values (existing fader data is erased). In Relative mode, fader moves are rerecorded relative to the existing fader data. Fader data includes Input Channel level, Bus Out master levels, Aux Out master levels, the Stereo Out level, Remote layer faders.

The following table explains Fader Edit mode operation (TO END: off. Edit Out: off).

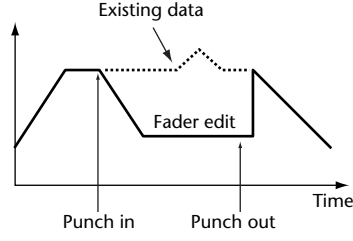
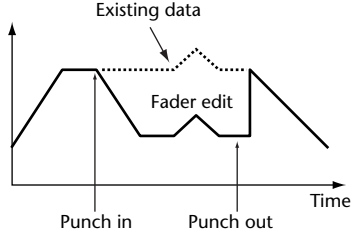
Absolute	Relative
<p>Fader edits are recorded as absolute values and existing fader data between the punch in and out points is erased.</p>	<p>Fader edits are rerecorded relative to the existing fader data.</p>
	

**⑨ TOUCH SENSE section**

This section enables or disables the Touch Sense function for punching in and out fader events. The IN button enables the Touch Sense function for punch in. The OUT button enables the Touch Sense function for punch out. You can set these buttons individually. If the Fader Touch Sense parameter is set to “Disabled,” on the Setup | Prefer2 page, this section is grayed out.

**⑩ OVERWRITE section**

This section enables you to select parameters to be recorded on the first pass, and rerecorded (i.e., overwritten) on subsequent passes. You can select or deselect these parameters while recording is in progress (see page 184).

**⑪ AUTOMIX ENABLED/DISABLED**

This parameter enables or disables the Automix. When the parameter is set to DISABLE, you cannot record or play back an Automix.

**⑫ NEW**

Move the cursor to the NEW button, then press [ENTER] to create a new Automix. When you create a new Automix, a Scene recall event to recall the current Scene (i.e., the last Scene recalled) is automatically inserted at the start of the Automix. (You can edit this event so that you will be able to recall another Scene.)

**⑬ UNDO**

Move the cursor to this button, then press [ENTER] to undo various Automix operations (Undo function). When you record new events in an Automix, or when you perform an offline edit, the current Automix data is copied to the Undo buffer. You can retrieve the data from the buffer by moving the cursor to the UNDO button and pressing [ENTER] while Automix is stopped. You can also cancel the Undo operation (Redo function).

**Tip:**

- The Undo buffer is cleared when you turn off the power to the DM1000. If you want to save the contents of the Undo buffer, perform the undo operation, then store the Automix.
- However, you cannot undo the operations performed on the Event Edit page.

**⑭ AUTO REC**

Move the cursor to the AUTO REC button, then press [ENTER] to place the DM1000 in Automix record ready mode. The button becomes highlighted. In this state, when the DM1000 receives the appropriate timecode, it automatically starts Automix recording. Record ready mode is not canceled, even if Automix recording is stopped, unless you move the cursor to this button and press [ENTER].

**⑮ REC**

Move the cursor to the REC button, then press [ENTER] to place the DM1000 in Automix record ready mode. The button starts to flash. In this state, when the DM1000 receives the appropriate timecode, it automatically starts Automix recording.

Unlike the AUTO REC button, however, record ready mode is canceled when recording is stopped.

If you move the cursor to this button and press [ENTER] during Automix playback, the DM1000 engages record ready mode.

**⑯ PLAY**

If the timecode source is set to internal, move the cursor to the PLAY button and press [ENTER]. Automix recording or playback starts.

If you selected an external timecode source, as soon as the DM1000 receives the external timecode, recording or playback starts, and this button turns on automatically. After you stop Automix by pressing the STOP button or ABORT button, you can restart recording or playback by pressing this button as long as the DM1000 is still receiving timecode.

**⑰ STOP**

Move the cursor to this button, then press [ENTER] to stop Automix recording or playback. (If you stop recording, a confirmation window appears asking whether you wish to update the Automix data.) The button remains highlighted while Automix is stopped.

**⑱ ABORT**

This button aborts the current recording without updating the existing Automix data.

## Automix Memory Page

The Automix Memory page enables you to store and recall Automixes. The lower half of this page is identical to the Automix Main page.

To locate the Automix | Memory page, press the DISPLAY ACCESS [AUTOMIX] button repeatedly until the page appears.

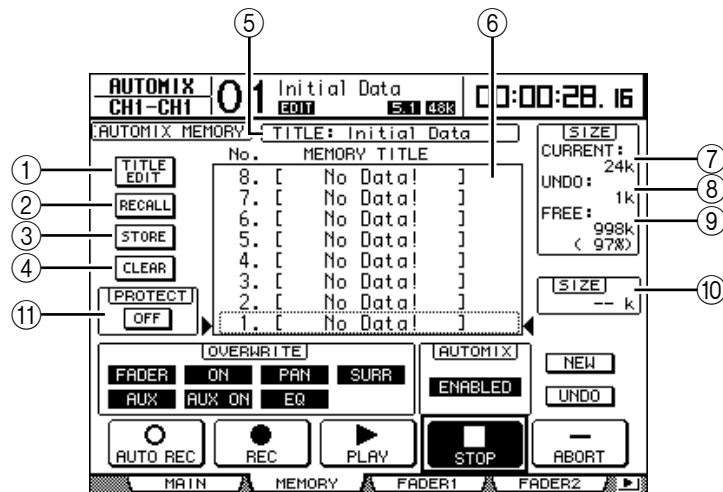

- ① **TITLE EDIT**  
This button enables you to edit the title of the Automix memory selected in the center column.
- ② **RECALL**  
This button recalls the Automix memory selected in the center column.
- ③ **STORE**  
This button enables you to store the current Automix to the memory selected in the center column.
- ④ **CLEAR**  
This button clears the Automix memory selected in the center column.
- ⑤ **TITLE**  
This parameter displays the title of the current Automix.
- ⑥ **MEMORY TITLE column**  
This column enables you to select an Automix memory to be recalled or stored. The column lists the titles of Automix memories. An empty Automix memory has a title of “No Data!”
- ⑦ **CURRENT**  
This parameter displays the size of the current Automix.
- ⑧ **UNDO**  
This parameter displays the size of the current Undo buffer.
- ⑨ **FREE**  
This parameter displays the amount of free memory available for storing the current Automix.
- ⑩ **SIZE**  
This parameter displays the size of the Automix memory selected in the center column.

⑪ **PROTECT ON/OFF**

To protect the contents of the Automix memory selected in the MEMORY TITLE column, move the cursor to this button and press [ENTER]. A padlock icon (🔒) appears next to the titles of Automix memories that are write-protected. You cannot store, clear, or edit the title of write-protected Automix memories.

For details on the Store, Recall, Title Edit, and Clear functions, see “General Library Operation” on page 165.

## Fader1 & 2 pages

The Fader1 & 2 pages enable you to edit fader positions while viewing the current fader position and the fader data recorded in the Automix.

To locate the Fader1 or 2 page, press the DISPLAY ACCESS [AUTOMIX] button repeatedly until the page appears.

During Automix playback, fader positions are displayed graphically as black bars on the Automix | Fader1 or 2 page. The Fader1 page displays fader positions for Input Channel 1 through 48 and Stereo out. The Fader2 page displays fader positions for Bus Outs 1–8 and Aux Outs 1–8.

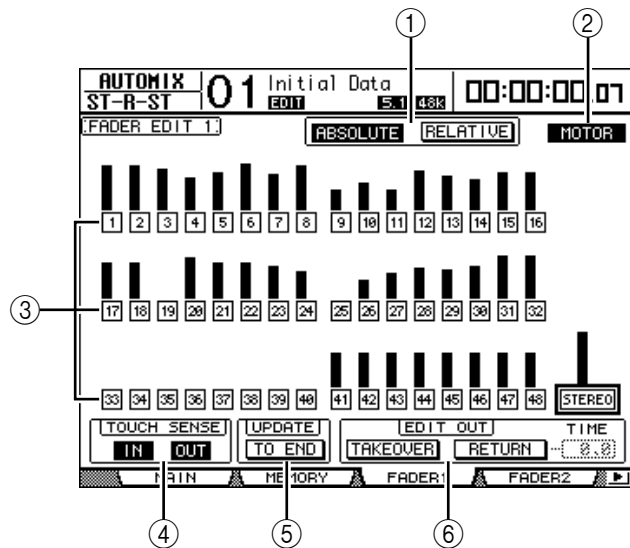

When the Fader mode is set to Fader, each page displays Input and Output Channel levels. When the Fader mode is set to Aux, each page displays Aux Send levels.

During rerecording, the Fader1 and 2 pages display the existing fader data in bar graphs. While fader events are being recorded, arrows appear next to each fader bar. A downward arrow indicates that the current fader position is higher than that specified by the existing fader data. An upward arrow indicates that the current fader position is lower than that specified by the existing fader data.

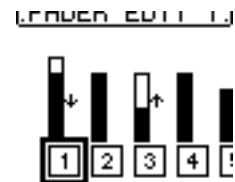

① **ABSOLUTE & RELATIVE**

These buttons are the same as those on the Main page (see page 191).

② **MOTOR**

This button turns the fader motors on or off for Automix playback. The button is highlighted when the motors are on.

**Tip:** You cannot turn off the motors during Automix recording. Even if this button is turned off, the motors are automatically turned on when recording starts.

**③ Edit Safe buttons**

The numbered buttons below each fader bar are Edit Safe buttons, which prohibit Automix recording on certain channels. A channel is set to safe and excluded from Automix recording when its button is highlighted. However, you can play existing events and use faders, Encoders, and [ON] buttons on safe channels. This is useful for rehearsing mix moves.

**Tip:**

- You can make all channels safe simultaneously by selecting a non-highlighted button and double-clicking the [ENTER] button. A confirmation window appears.
- You can cancel all safe channels simultaneously by selecting a highlighted button and double-clicking the [ENTER] button. A confirmation window appears.

**④ TOUCH SENSE**

This function is the same as that on the Automix Main page.

**⑤ UPDATE**

This button is the same as that on the Automix Main page.

**⑥ EDIT OUT**

The TAKEOVER and RETURN buttons are the same as those on the Automix | Main page. The EDIT OUT section on this page also contains the TIME parameter. This parameter determines the time required for faders to return to the levels specified by the existing Automix data when the RETURN button is turned on.

## Editing Events Offline

You can edit recorded Automix events offline on the Event Job and Event Edit pages. You can perform offline editing only while the Automix function is stopped.

### Event Job Page

On the Event Job page, you can erase, copy, move/merge, or trim specified events on specified channels between specified in and out points.

- 1 Press the **DISPLAY ACCESS [AUTOMIX]** button repeatedly until the Automix | Event Job page appears.

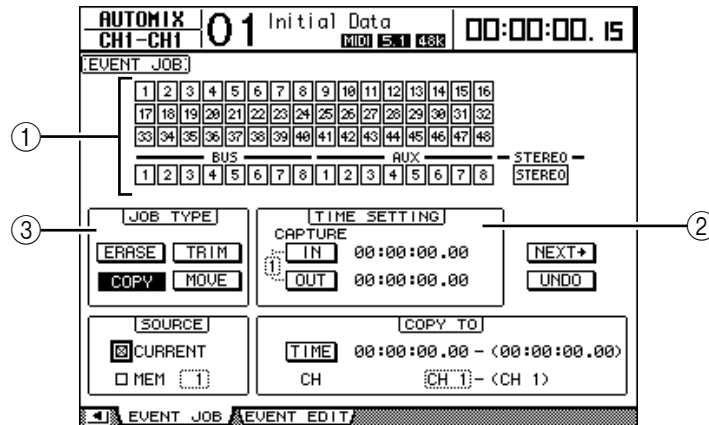

- ① **Channel buttons**

These buttons enable you to select the channels for which you want to edit Automix data.

- ② **TIME SETTING section**

This section enables you to specify the region of Automix data to be edited (IN and OUT points).

- ③ **JOB TYPE section**

This section enables you to select the job type. If you select “MEM” in the SOURCE section, the MERGE button replaces the MOVE button.

- 2 Use the **Channel buttons to select channels for which you want to edit Automix data.**

You can select multiple Input Channels, Bus Outs, Aux Outs, and the Stereo Out.

**Tip:**

- You can select all Channel buttons simultaneously by moving the cursor to a non-highlighted button and double-clicking the [ENTER] button. A confirmation window appears.
- You can deselect all selected Channel buttons simultaneously by moving the cursor to a highlighted button and double-clicking the [ENTER] button. A confirmation window appears.

- 3 **Specify the region of Automix data you want to edit by setting the IN and OUT parameters in the TIME SETTING section.**

You can also capture the IN and OUT points on-the-fly by moving the cursor to the IN or OUT button and pressing the [ENTER] button. To modify the captured positions, move the cursor to the value you wish to change, and rotate the Parameter wheel or press the [INC]/[DEC] buttons. Press the [ENTER] button to reset the currently-selected digit to “00.” Up to eight IN and OUT timecode values can be captured and stored in the eight Capture memories. The currently-selected Capture memory number (1–8) appears to the left of the IN and OUT buttons. Move the cursor to the Capture memory number, and rotate the Parameter wheel or press the [INC]/[DEC] buttons to select the desired Capture memory.

**4 Move the cursor to the desired Job button in the Job Type section, then press [ENTER].**

The following Jobs are available. Certain Jobs feature an extra parameter below the TIME SETTING section.

■ **ERASE**

This button erases the specified range of Automix data.

■ **COPY**

This button copies the specified range of Automix data to another position. When you select this button, the SOURCE and COPY TO sections appear below the TIME SETTING section.

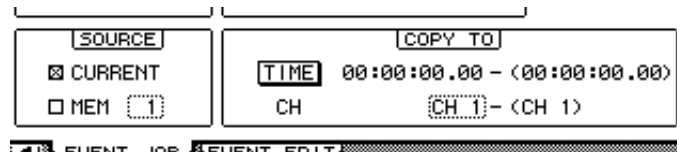

• **SOURCE section**

This section enables you to select the copy source Automix.

• **COPY TO section**

- **TIME**

This parameter specifies the start point to which the specified data is to be copied. (The number in parentheses on the right indicates the end point of the destination.) You can also capture the start point on-the-fly by moving the cursor to the TO button and pressing the [ENTER] button to capture the current position. To modify the captured positions, move the cursor to the value you wish to change, then rotate the Parameter wheel or press the [INC]/[DEC] buttons. Press the [ENTER] button to reset the currently-selected digit to “00.”

- **CH**

This parameter specifies the channel to which you want to copy the specified data. If multiple channels are selected as the copy source, use the CH parameter box to specify the number of the top channel in the destination. (The number in parentheses on the right indicates the number of the last channel in the destination.)

For example, if eight channels are selected as the copy source and you specify “17” in the CH parameter box, the copy destination will be Channels 17 through 24.

■ **MOVE/MERGE**

The function of this button changes depending on the SOURCE section setting.

If you select CURRENT (current Automix) in the SOURCE section, this button becomes the MOVE button, which moves the specified range of Automix data to another position.

If you select MEM (Automix memories 1–16) in the SOURCE section, this button becomes the MERGE button, which merges the specified range of Automix data with other Automix data.

When you select this Job, the SOURCE section and MOVE TO (MERGE TO) section appear below the TIME SETTING section.

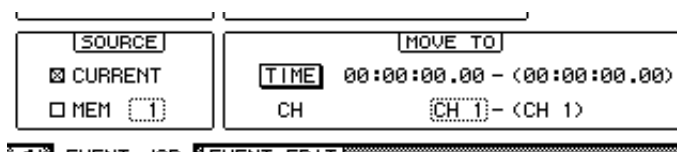

- **SOURCE section**

These parameters select the source Automix to be moved or merged. If you select CURRENT (the current Automix), you can use the MOVE button. If you select MEM (Automix memory), you can use the MERGE button. If you select MEM, specify the Automix memory number in the small parameter box on the right.

- **MOVE TO (MERGE TO) section**

- **TIME**

This parameter specifies the start point to which the specified data is to be moved or merged. (The number in parentheses on the right indicates the end point of the destination.) You can also capture the start point on-the-fly by moving the cursor to the TO button, then pressing the [ENTER] button to capture the current position. To modify the captured positions, move the cursor to the value you wish to change, and rotate the Parameter wheel or press the [INC]/[DEC] buttons. Press the [ENTER] button to reset the currently-selected digit to “00.”

- **CH**

This parameter specifies the channel to which the specified data is to be moved or merged. If multiple channels are selected as the move/merge source, use the CH parameter box to specify the number of the top channel in the destination. (The number in parentheses on the right indicates the number of the last channel in the destination.) For example, if eight channels are selected as the move/merge source and you specify “17” in the CH parameter box, the move/merge destination will be Channels 17 through 24.

- **TRIM**

This button enables you to adjust the level of fader events in the specified range of Automix data. When you select this Job, the TRIM EDIT section appears below the TIME SETTING section.

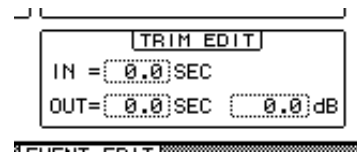

- **IN**

This parameter determines the time required for the fader to reach the level specified by the Trim amount parameter.

- **OUT**

This parameter determines the time required for the fader to return to the previous level.

- **Trim amount**

This parameter specifies the trim amount in the range of -96 dB to +96 dB.

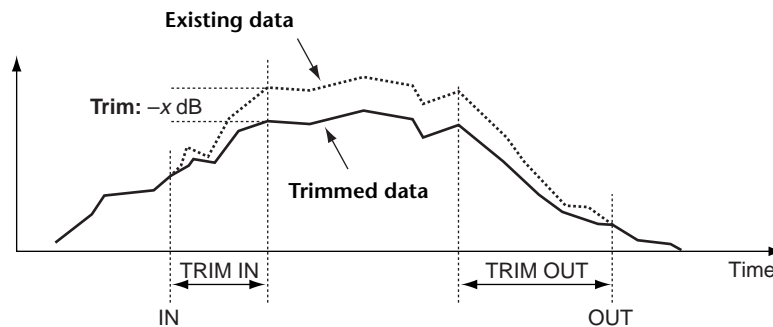



**5 After setting all necessary parameters, move the cursor to the **NEXT+** button on the right side of the page, then press [ENTER].**

The PARAMETERS window appears, which enables you to select parameters to be edited, and to perform the selected Job.

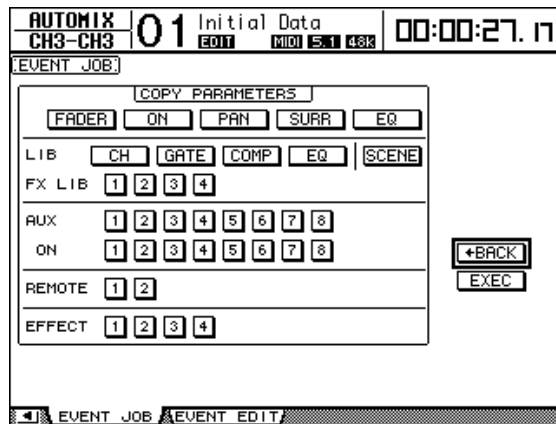

A parameter is selected when its button is highlighted. (You can specify multiple parameters.) These buttons correspond to the following parameters:

Button	Events	
FADER	Channel Fader events (Inputs Channels, Bus Out masters, Aux Out masters, and the Stereo Out)	
ON	Channel Mute events	
PAN	Input Channel pan events	
SURR	Input Channel surround pan, LFE level, and DIV parameter events	
EQ	Channel EQ events	
LIB	CH	Channel library recall events
	GATE	Gate library recall events
	COMP	Comp library recall events
	EQ	EQ library recall events
	SCENE	Scene recall events
FX LIB	1-4	Effects library recall events of each internal effects processor
AUX	1-8	Level events of each Aux Send
ON	1-8	Mute events of each Aux Send
REMOTE	1-2	User Defined Remote Layer events
EFFECT	1-4	Parameter events for each internal effects processor

**Tip:**

- You can select all parameter buttons simultaneously by moving the cursor to a non-highlighted button and double-clicking the [ENTER] button. A confirmation window appears.
- You can deselect all selected parameter buttons simultaneously by moving the cursor to a highlighted button and double-clicking the [ENTER] button. A confirmation window appears.

- 6 To execute the selected Job, move the cursor to the EXECUTE button, then press [ENTER].

A confirmation window appears. Move the cursor to the YES button, then press [ENTER] to execute the Job.

**Tip:**

- Move the cursor to the NO button, then press [ENTER] to abort the Job.
- To return to the previous page without executing the Job, move the cursor to the **+BACK** button, then press [ENTER].

## Event Edit Page

The Event Edit page enables you to edit, duplicate, delete events and insert new events.

- 1 Press the DISPLAY ACCESS [AUTOMIX] button repeatedly until the Automix | Event Edit page appears.

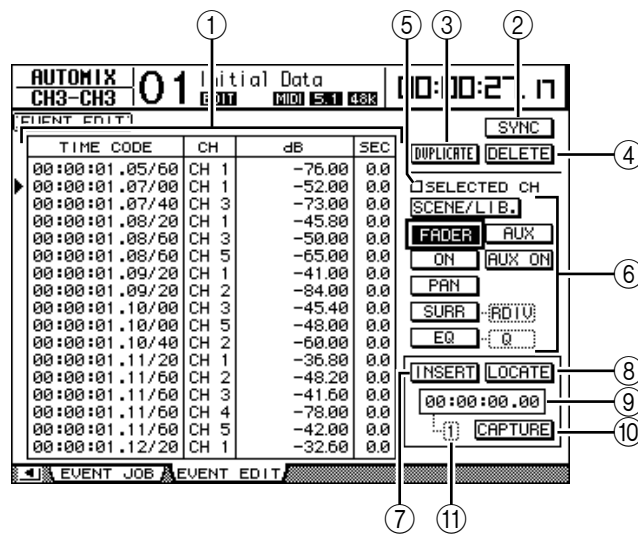

① **Event list**

This list contains the Automix event time, channels, and parameter values. The currently-selected event in the list is indicated by a triangular icon (▶). Use the Up and Down cursor buttons to select an event, and use the Left and Right cursor buttons to select a parameter value of the selected event.

② **SYNC**

This button synchronizes the event list to the current timecode position. Move the cursor to this button, then press [ENTER] to select events closest to the current timecode position.

③ **DUPLICATE**

This button duplicates the event selected in the list.

④ **DELETE**

This button deletes the event selected in the list.

⑤ **SELECTED CH**

When this option is on, only events of the channels currently selected by the channel [SEL] buttons are displayed in the list.

⑥ **Event select buttons**

These buttons select the type of events to be displayed in the event list.

**⑦ INSERT**

This button inserts a new event in the position selected in the event list.

**⑧ LOCATE**

This button locates events at (or closest to) the timecode position indicated on the Capture memory display.

**⑨ Capture memory display**

This display counter indicates the captured timecode position.

**⑩ CAPTURE**

This button captures the current timecode position. Up to eight timecode values can be captured and stored in the eight Capture memories.

**⑪ Capture memory**

This box indicates the number of the currently-selected Capture memory (1–8).

**2 Use the Event select buttons to select the type of events to be displayed in the event list.**

The format of the list varies depending on the selected event. The following table shows the events that correspond to the Event select buttons, and the list format:

Button	Events Listed	List Format
SCENE/LIB	Library and Scene recall events	TIME CODE, CH, SCENE/LIB
FADER	Channel Fader events (Inputs Channels, Bus Out masters, Aux Out masters, and the Stereo Out)	TIME CODE, CH, dB, SEC
ON	Channel Mutes (ON/OFF)	TIME CODE, CH, ON/OFF
PAN	Pan	TIME CODE, CH, L-C-R
SURR-PAN	Surround Pan	TIME CODE, CH, SURR
SURR-LFE	Surround LFE	TIME CODE, CH, dB
SURR-DIV	Surround DIV	TIME CODE, CH, DIV
SURR-RDIV	Surround RDIV	TIME CODE, CH, RDIV
EQ-ON	EQ On/Off	TIME CODE, CH, ON/OFF
EQ-FREQ	EQ Frequency	TIME CODE, CH, BAND/Hz
EQ-Q	EQ Q	TIME CODE, CH, BAND/Q
EQ-GAIN	EQ Gain	TIME CODE, CH, BAND/dB
AUX	Aux Send 1–8 levels	TIME CODE, CH, AUX, dB
AUX ON	Aux Send 1–8 mutes	TIME CODE, CH, AUX, ON/OFF

**Tip:** When the *SELECTED CH* check box is on, only events of the currently-selected channel are displayed.

**Note:** If the data size of the selected event exceeds 2 MB, the message “Automix Work Memory Full!” appears, and not all events may be displayed. In this case, check the *SELECTED CH* check box to display only events of the selected channel.

**3 To duplicate or delete events, select an event by moving the triangular icon (▶) to the event in the list, then select the DUPLICATE or DELETE button.**

**4 To modify the event time, channel or parameter value, move the cursor to a parameter value you wish to change, then rotate the Parameter wheel or press the [INC]/[DEC] buttons.**

- 5 To locate an event, play the Automix and move the cursor to the CAPTURE button, then press [ENTER].**

The current position is captured and indicated in the Capture memory display.

**Tip:**

- *To modify the captured position, move the cursor to the Capture memory display, then rotate the Parameter wheel or press the [INC]/[DEC] buttons. Press the [ENTER] button to reset the currently-selected digit to “00.”*
- *Up to eight timecode values can be captured in the Capture memories. To recall another Capture memory, move the cursor to the parameter box located to the left of the CAPTURE button, then select the desired Capture memory number (1–8).*

- 6 To recall the event at the captured position, move the cursor to the LOCATE button, then press [ENTER].**

The event at (or closest to) the captured position is displayed and selected in the event list.

- 7 To insert a new event, use the Event select buttons to select the type of event that you want to insert. Use the Capture memory display to specify the point at which you want to insert the new event. Move the cursor to the INSERT button, then press [ENTER].**

The new event is inserted at the position currently displayed in the Capture memory display.

# 17 Remote Control

This chapter describes the Remote function, which enables you to control external equipment directly from the DM1000 top panel.

## About Remote Function

The DM1000's Remote function enables you to control external DAW (Digital Audio Workstation) equipment, MIDI devices, recorders, etc.

There are three types of Remote functions (Remote 1 & 2, and Machine Control):

### ■ REMOTE 1 (Remote Layer 1)

### ■ REMOTE 2 (Remote Layer 2)

To use these Remote functions, you must connect the DM1000 to a target device via USB and operate the faders, Encoders and [ON] buttons on the top panel to control the external device remotely.

You can specify a target device and parameter values on the Remote | Remote1 and Remote 2 pages. These layers are enabled when you turn on the LAYER [REMOTE 1] and [REMOTE 2] buttons respectively. During Remote operation, the controls on the top panel enable you to control the external device. (You cannot adjust the DM1000's parameters unless you select a different layer.)

You can assign functions of a target device to the controls on the top panel of the DM1000 by using Remote Layers 1 and 2. The following targets are available for remote control:

- **ProTools** ..... You can remotely control Digidesign Pro Tools.
- **Nuendo** ..... You can remotely control Steinberg Nuendo.
- **General DAW** ..... You can remotely control DAW software that supports the protocol used by Pro Tools.
- **User Defined** ..... You can also assign MIDI messages to the faders, [ON] buttons, or Encoders to remotely control a connected MIDI device, such as a synthesizer.
- **User Assignable Layer** ..... You can combine the DM1000 channels to create a custom layer. (See page 255 for more information on this function.)

**Tip:** ProTools, Nuendo, and General DAW targets can be assigned to only one layer at a time. If you have already assigned a ProTools, Nuendo, or General DAW target to Remote Layer 1 or 2, you cannot assign other targets to the other Remote Layer.

### ■ Machine Control

From the Remote | Machine Control page, you can control an external recording machine that is connected to the DM1000 MIDI port, REMOTE connector, USB port, or optional MY8-mLAN card. There are two types of commands used for machine control.

- **MMC** ..... MMC stands for MIDI Machine Control. MMC commands can be transferred via the MIDI ports, USB port, and Slot 1 if an MY8-mLAN card is installed.
- **P2** ..... P2 protocol is used by the Tascam DA-98HR and other professional video machines. This command can be transferred via the REMOTE connector.

**Tip:** To control external devices from the DM1000, you can also use the User Defined buttons or the CONTROL connector as a GPI (General Purpose Interface). Refer to Chapter 19 "Other Functions" on page 249 for more information.

## Pro Tools Remote Layer

The DM1000 features Remote Layer 1 and 2 targets especially designed for controlling Pro Tools.

### Connections and Configuring Pro Tools

Follow the steps below to connect the DM1000 to your computer via the USB port so that you can control Pro Tools from the DM1000.

**Note:** You cannot control Pro Tools via MIDI connections. Be sure to connect your computer via the USB or an optional MY8-mLAN card installed in one of the DM1000 slots.

#### ■ Configuring Windows Computers

- 1 Connect the DM1000 TO HOST USB port to a USB port on your PC using a USB cable.

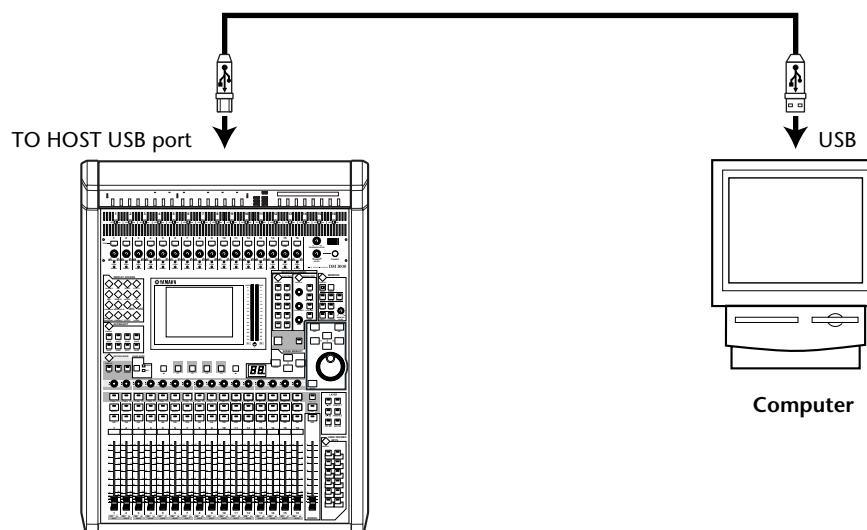

- 2 Install the necessary USB drivers included on the DM1000 CD-ROM.  
See the Studio Manager Installation Guide for more information on installing the drivers.

#### ■ Configuring Macintosh Computers

- 1 Connect the DM1000 TO HOST USB port to a USB port on your Mac using a USB cable.
- 2 Install the required USB driver included on the DM1000 CD-ROM.  
See the Studio Manager Installation Guide for more information on installing the driver.
- 3 Install OMS.

The DM1000 communicates with Pro Tools via OMS (Open Music System) software. If you have not installed OMS on your Mac, use the OMS installer included on the DM1000 CD-ROM to install OMS.

- 4 Launch Pro Tools.
- 5 Choose OMS Studio Setup from the Setups menu, and configure OMS as necessary.

Refer to the documentation that came with OMS for more information on configuring the OMS Studio Setup menu. OMS recognizes the DM1000 as a USB MIDI interface that features eight ports.

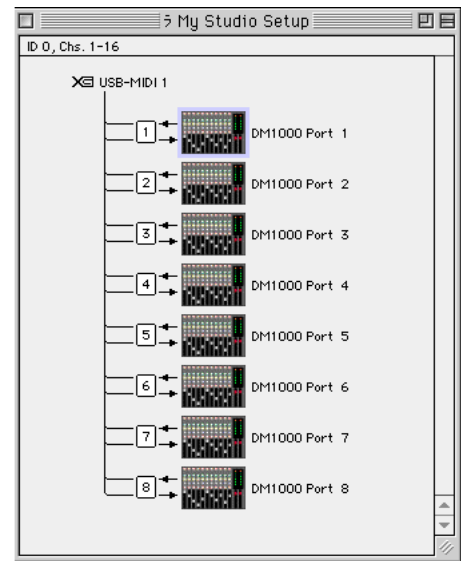

- 6 Choose Peripherals from the Setups menu to open the Peripherals window.
- 7 Double-click the MIDI Controllers tab.
- 8 Refer to the screen below to set the Type, Receive From, Send To, and #Ch's parameters.

The DM1000 can emulate up to two MIDI controllers.

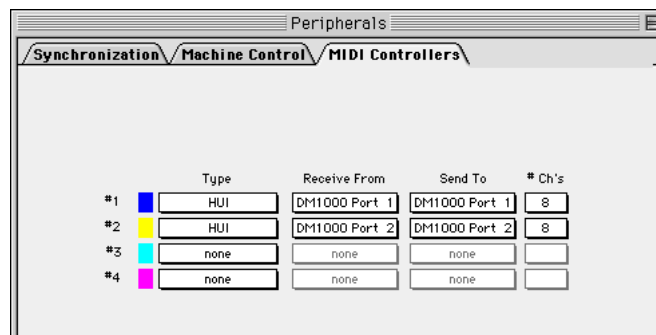

**Tip:** To control Pro Tools remotely, you need one port for every eight audio channels.

- 9 When you finish setting the parameters, close the window.

## Configuring the DM1000

Follow the steps below to set up the DM1000 so that you can remotely control Pro Tools from the DM1000 Remote Layer 1.

- 1 Press the DISPLAY ACCESS [SETUP] button repeatedly until the Setup | MIDI/Host page appears.

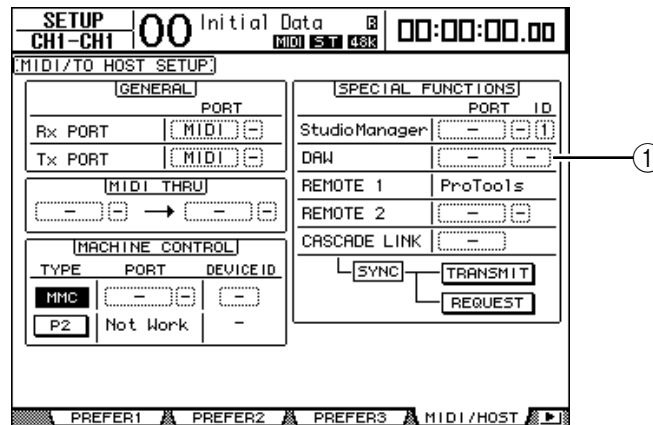

- 2 Move the cursor to the first DAW parameter box (①) in the SPECIAL FUNCTIONS section, then rotate the Parameter wheel to select USB as the port.
- 3 Press [ENTER] to confirm the setting.
- 4 Move the cursor to the adjacent parameter box (on the right), then rotate the Parameter wheel to specify the port ID.

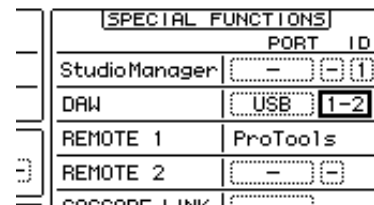

*Note: If you select an incorrect port, you will be unable to use the Remote function. Be sure to match the port ID with that specified in the Peripherals window in Pro Tools.*

- 5 Press the DISPLAY ACCESS [REMOTE] button, then press the [F1] button. The Remote | Remote 1 page appears.

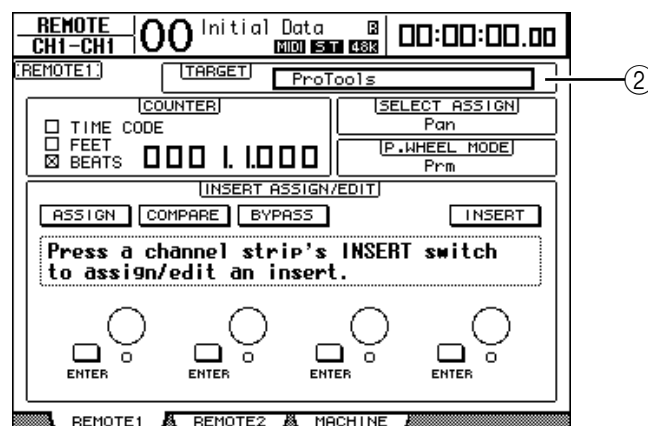



**6 Select ProTools (as the target device) for the Target parameter (②) located in the upper-right corner of the page.**

By default, Remote Layer 1 target is set to ProTools. If another target has been selected, rotate the Parameter wheel to select ProTools.

**7 Press the LAYER [REMOTE 1] button.**

Remote Layer 1 is now available for control, enabling you to remotely control Pro Tools.

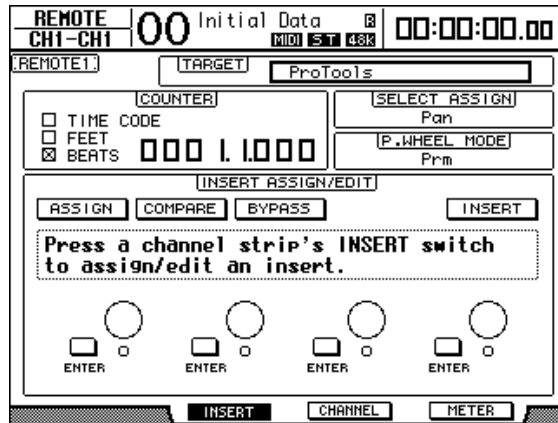

**Note:** When the Pro Tools Remote Layer is selected, the DM1000's top panel faders, Encoders and other channel layer buttons control Pro Tools. To control the DM1000, you need to select an Input Channel layer or the Master layer.

**Tip:**

- If an optional MB1000 Peak Meter Bridge is installed, Pro Tools channel levels are displayed on the MB1000 meters.
- Pressing the [REMOTE 2] button and setting the TARGET parameter to ProTools enables you to control Pro Tools from the Remote Layer 2. In this case, the Remote Layer 1 Target parameter is automatically set to No Assign.

## Display

While the Pro Tools layer is selected, you can use the [F2]–[F4] buttons as well as the left and right [◀]/[▶] Tab Scroll buttons to select display modes. You can select the following display modes using these buttons:

### ■ Insert Display mode ( [F2] button)

Press the [F2] button to select Insert Display mode. In this mode, you can assign and edit plug-ins.

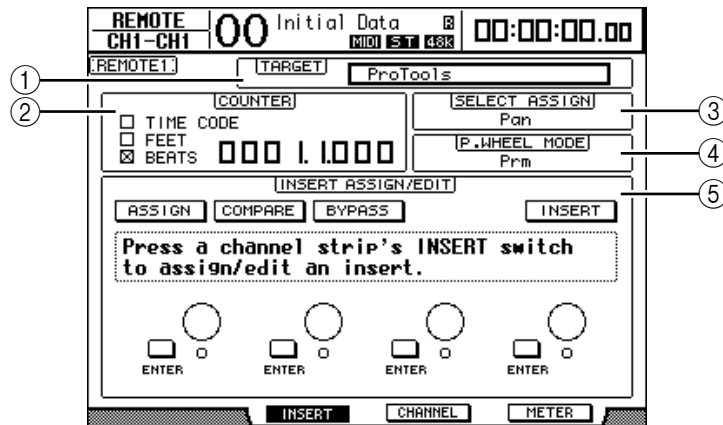

#### ① TARGET

This parameter enables you to select the remote control target device.

#### ② COUNTER

This counter indicates the current position. This counter works in unison with the timecode counter on Pro Tools. The display format of the counter is specified in Pro Tools. The following three check boxes in the COUNTER section indicate the currently-selected format.

- **TIME CODE:**..... Pro Tools timecode format is set to “Time Code.”
- **FEET:** ..... Pro Tools timecode format is set to “Feet:Frames.”
- **BEATS:**..... Pro Tools timecode format is set to “Bars:Beats.”
- **If no check boxes are selected:**.....Pro Tools timecode format is set to “Minutes:Seconds” or “Samples.”

#### ③ SELECT ASSIGN

This parameter indicates the current function of the Encoders. For example, Pan, PanR, SndA, SndB, SndC, SndD, or SndE (see page 212).

#### ④ P.WHEEL MODE

This parameter indicates the function currently assigned to the Parameter wheel (see page 214).

⑤ **INSERT ASSIGN/EDIT section**

This section enables you to insert plug-ins into Pro Tools channels and adjust plug-in settings. Use the left and right [ ◀ ]/[ ▶ ] Tab Scroll buttons to change the parameters displayed in this section.

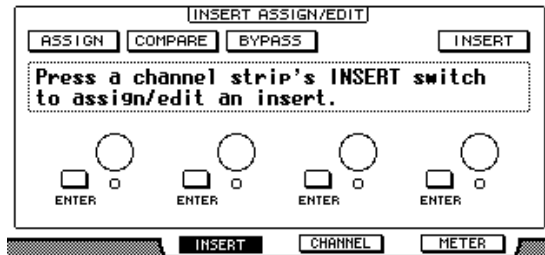

- **ASSIGN** ..... Turn on this button to insert plug-ins into Pro Tools channels. (If you are using the TDM system, you can also assign outboard effects processors.)
- **COMPARE** ..... You can compare your edits with the original settings by turning on this button. This button works in unison with the Compare button in the Pro Tools Inserts and Sends windows.
- **BYPASS** ..... Turning on this button bypasses the plug-ins (see page 221).
- **INSERT/PARAM** ..... Switching this button to INSERT enables you to assign plug-ins using four rotary controls on the page. Switching this button to PARAM enables you to adjust the plug-in parameters using the four rotary controls (see page 220).
- **Information box** ..... This box displays plug-in parameter names, values, alarm messages from Pro Tools, etc.
- **Rotary controls 1–4** ..... These controls enable you to select plug-ins or adjust the selected plug-in parameters.

■ **Channel Display mode ( [F3] button)**

Press the [F3] button to select this display mode, in which the parameter controls for tracks 1–16 are displayed.

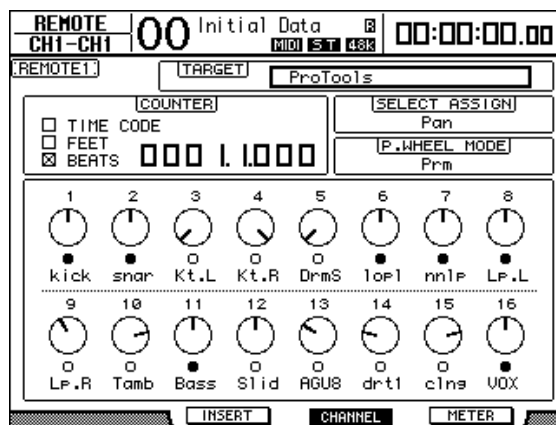

- **Parameter controls 1–16** ..... Channel parameter controls, such as channel 1–16 panpots, Send A–E send levels, etc. are displayed.

### ■ Meter Display mode ( [F4] button)

Press the [F4] button to select this display mode, in which the level meters for tracks 1–16 are displayed.

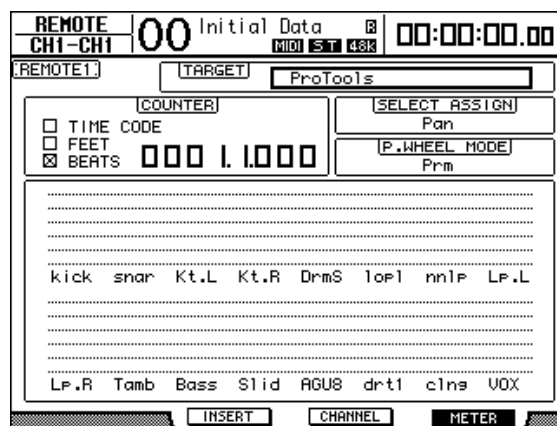

- **Channels 1–16.....** The channel 1–16 levels or Send levels are displayed.

## Control Surface Operation

When the Pro Tools Remote Layer is selected, the DM1000 controls on the top panel engage the following functions:

### ■ Channel Strip section

- **Encoders**  
Encoders adjust the panpots or Aux Send levels. Use the ENCODER MODE [PAN] or [AUX] button to select a parameter to edit.
- **[SEL] buttons**  
These buttons select Pro Tools channels, inserts, and Automation mode. By default, these buttons select channels.
- **[SOLO] buttons**  
These buttons solo Pro Tools channels. The button indicators for the soloed channels light up.
- **[ON] buttons**  
These buttons mute Pro Tools channels.
- **Faders**  
The faders set Pro Tools channel levels, including the audio tracks, MIDI tracks, master fader, Aux Ins, etc. If 16 or fewer channels are displayed in Pro Tools, faders are assigned starting from the left-most channel.

### ■ STEREO section

- **[AUTO] button**  
This button switches Pro Tools Automation mode.

### ■ AUX SELECT Section

- **[AUX 1]–[AUX 5] buttons**  
These buttons select Sends A–E so that you can adjust the corresponding Pro Tools channel send level.

- **[AUX 6] button**  
Press and hold down this button and press the desired [SEL] button to reset the corresponding channel fader level.  
Press and hold down this button and press the desired Encoder push-switch to reset the corresponding channel panpot to center. While you are holding down the [AUX 6] button, the SELECT ASSIGN parameter indicates “DFLT.”
- **[AUX 8] button**  
Use this button along with the desired [SEL] button to assign a plug-in to the corresponding Pro Tools channel.

### ■ ENCODER MODE section

- **[PAN] button**  
When you turn on this button, the Encoders function as Pro Tools channel panpots.
- **[AUX] button**  
When you turn on this button, the Encoders function as Send A–E level controls. AUX Send destination is selected in the AUX SELECT section. When you press this button, Send A is selected as the destination automatically.  
If the Encoders are currently set to control the Send A–E levels, the button indicator lights up.

### ■ FADER MODE section

- **[FADER/AUX] button**  
This button selects Flip mode (see page 218) for faders, Encoders, and [ON] buttons.

### ■ DISPLAY ACCESS section

- **[AUTOMIX] button**  
To display channel Automation mode, press this button while a Channel Display mode or Meter Display mode page is selected.
- **[PAIR/GROUP] button**  
Press this button while a Channel Display mode or Meter Display mode page is selected to display a Group ID to which each channel belongs.
- **[EFFECT] button**  
Press this button to display or hide the Inserts window in Pro Tools.

### ■ Display section

- **Tab Scroll buttons**  
These buttons switch the INSERT ASSIGN/EDIT parameter settings on Insert Display mode pages.
- **[F1] button**  
Press this button to turn off the Peak Hold indicator on Meter Display mode pages.

## ■ Data Entry section

- **[ENTER] button**

This button switches the on/off status of the buttons on the display.

- **Left, Right, Up, Down ([◀]/[▶]/[▲]/[▼]) cursor buttons**

These buttons move the cursor on the display.

- **[INC] & [DEC] buttons**

The [INC] button works the same as the Enter key on your computer keyboard. The [DEC] button works the same as the Esc key on your computer keyboard.

- **Parameter wheel**

The Parameter wheel enables you to adjust the currently-selected parameter, or execute the shuttle and scrub operation. By default, it adjusts the value of the currently-selected parameter (The P.WHEEL MODE parameter indicates “Prm.”).

## ■ USER DEFINED KEYS section

- **[1]–[12] buttons**

You can assign one of 164 parameters to each of these buttons. In particular, if you assign any of 53 Remote Control parameters to these buttons, you can operate the transport section and select various Pro Tools modes from the DM1000 top panel. See page 257 for more information on assigning the parameters to the buttons.

Parameter	Function
DAW REC	Places Pro Tools in Record Enabled mode. The button indicator flashes while the transport section is stopped. The indicator lights up when recording starts.
DAW PLAY	Starts playback from the current cursor position.
DAW STOP	Stops playback and recording.
DAW FF	Fast forwards the cursor position.
DAW REW	Fast rewinds the cursor position.
DAW SHUTTLE	Switches Wheel mode to Shuttle.
DAW SCRUB	Switches Wheel mode to Scrub (Jog).
DAW AUDITION	You can audition the pre-roll, post-roll, in-point area, or out-point area by holding down the button to which this function is assigned and pressing a button to which DAW PRE, DAW POST, DAW IN, or DAW OUT is assigned.
DAW PRE	Plays back from the pre-roll point up to the beginning of the selected area.
DAW IN	Plays back from the beginning of the selected area for a duration specified as the pre-roll.
DAW OUT	Plays back to the end of the selected area for a duration specified as the post-roll.
DAW POST	Plays back from the end of the selected area for a duration specified as the post-roll.
DAW RTZ	Moves the playback cursor to the beginning of the session.
DAW END	Moves the playback cursor to the end of the session.
DAW ONLINE	Toggles between on-line and off-line.
DAW LOOP	Toggles between Loop Playback on and off.
DAW QUICKPUNCH	Toggles between QuickPunch on and off.
DAW AUTO FADER	Correspond to the Automation Overwrite (Auto Enable) functions.
DAW AUTO MUTE	
DAW AUTO PAN	
DAW AUTO SEND	
DAW AUTO PLUGIN	
DAW AUTO SENDMUTE	

Parameter	Function
DAW AUTO READ	Select Automation modes.
DAW AUTO TOUCH	
DAW AUTO LATCH	
DAW AUTO WRITE	
DAW AUTO TRIM	
DAW AUTO OFF	
DAW AUTO SUSPEND	Cancels Automation recording and playback for all channels. When Automation is interrupted, the LED flashes, and channel strip controls maintain the current settings.
DAW AUTO STATUS	Displays the channel Automation mode (Read, Tch, Ltch, Wrt, or Off). The mode setting appears at the bottom of each channel on a Channel or Meter Display page when you press and hold the button to which this function is assigned.
DAW GROUP STATUS	Displays a Group ID (to which each channel belongs) below each channel number on a Channel or Meter Display page (in all caps for a main group and in lowercase letters for a sub-group).
DAW MONI STATUS	Pressing the key (to which this function is assigned) enables you to view the current monitoring mode and the channel strip type.
DAW CREATE GROUP	Pressing the key (to which this function is assigned) enables you to execute the function specified in the menu of the Pro Tools Group list.
DAW SUSPEND GROUP	Suspends all mix groups temporarily. Press the button again to undo suspension.
DAW WIN TRANSPORT	Shows or hides the Transport window.
DAW WIN INSERT	Shows or hides the Inserts window.
DAW WIN MIX/EDIT	Toggles between the Mix window and Edit window. (Both windows are not displayed at the same time.)
DAW WIN MEM-LOC	Shows or hides the Memory Locations window.
DAW WIN STATUS	Shows or hides the Status window.
DAW UNDO	Executes the Edit menu's Undo/Redo command.
DAW SAVE	Executes the Edit menu's Save command.
DAW EDIT MODE	Pressing the button (to which this function is assigned) repeatedly selects Shuffle, Slip, Spot, or Grid edit mode in this order.
DAW EDIT TOOL	Pressing the button (to which this function is assigned) repeatedly selects one of seven edit tools (Zoomer, Trimmer, Selector, Grabber, Smart Tool, Scrubber, and Pencil, in this order).
DAW SHIFT/ADD	Functions in the same way as Macintosh keyboard keys (Shift, Option, Control, and Alt). Pressing one of the buttons (to which these functions are assigned) along with another button enables you to execute various commands.
DAW OPTION/ALL	
DAW CTRL/CLUCH	
DAW ALT/FINE	
DAW BANK +	Executes the Bank Swap operation. Pressing the button (to which this function is assigned) switches the entire 16-channel bank.
DAW BANK -	
DAW Channel +	Executes the Channel Scroll operation. Pressing the buttons (to which these functions are assigned) enables you to scroll channels horizontally.
DAW Channel -	

Parameter	Function
DAW REC/RDY 1	Pressing the buttons (to which these functions are assigned) places the corresponding channel strips in Record Ready mode. At this time, the indicator of the button you pressed flashes. It lights up when recording starts.
DAW REC/RDY 2	
DAW REC/RDY 3	
DAW REC/RDY 4	
DAW REC/RDY 5	
DAW REC/RDY 6	
DAW REC/RDY 7	
DAW REC/RDY 8	
DAW REC/RDY 9	
DAW REC/RDY 10	
DAW REC/RDY 11	
DAW REC/RDY 12	
DAW REC/RDY 13	
DAW REC/RDY 14	
DAW REC/RDY 15	
DAW REC/RDY 16	
DAW REC/RDY ALL	If no channel strips are in Record Enabled mode, pressing the button (to which this function is assigned) places all channel strips in Record Enabled mode. The button indicator flashes if any channel strip in any bank is in Record Enabled mode. Pressing the button while the button indicator is flashing cancels Record Enabled mode for all channel strips.

## Selecting Channels

To select a single Pro Tools channel, press the [SEL] button that corresponds to the desired channel.

To select multiple Pro Tools channels simultaneously, while holding down one [SEL] button, press the [SEL] buttons of the other channels you wish to add. Press the [SEL] buttons again to cancel the selection.

## Setting Channel Levels

### 1 Make sure that the FADER MODE [FADER] indicator is lit steadily.

If the FADER MODE [FADER] and [AUX] indicators are flashing alternately, press the [FADER/AUX] button to turn on the [FADER] indicator.

### 2 Operate the faders to set channel levels.

Press and hold down the [AUX 6] button and press the desired [SEL] button to reset the corresponding channel fader level.



## Muting Channels

To mute Pro Tools channels, press the [ON] buttons. The [ON] button indicators of muted channels turn off. Grouped channels are muted together.

Press the [ON] buttons again to unmute channels. The [ON] button indicators of unmuted channels light up.

There are two mute modes in Pro Tools: Implicit mute and Explicit mute. You can check the mute mode by viewing the [ON] button indicators.

- **Implicit mute**.....This is a forced mute mode in which the channels are muted because other channels are soloed. In this mode, the [ON] button indicators flash.
- **Explicit mute** .....In this mode, the channels are muted or turned off manually. In this mode, the [ON] button indicators turn off.

## Panning Channels

You can adjust the Pro Tools channel pan settings.

### 1 Press the ENCODER MODE [PAN] button.

### 2 Press the [F2] button to select Channel Display mode.

On a Channel Display mode page, parameter controls 1–16 indicate the pan settings.

### 3 For stereo channel pan settings, press the [PAN] button again. The button indicator flashes.

Pressing the [PAN] button repeatedly toggles between the left and right panpots. When the left panpot is active, the SELECT ASSIGN parameter of the display indicates “Pan.” When the right panpot is active, the SELECT ASSIGN parameter indicates “PanR.”

### 4 Turn the Encoders to pan the channels.

Press and hold down the [AUX 6] button and press the desired Encoder push-switch to reset the corresponding channel panpot to center.

## Soloing Channels

To solo Pro Tools channels, press the [SOLO] buttons of the desired channels. Grouped channels are soloed together, and other channels are muted.

Press the [SOLO] buttons again to unsolo the channels.

## Configuring Sends A–E as Pre or Post

You can set Pro Tools channels for the selected Sends (A–E) to pre or post.

### 1 Press the AUX SELECT [AUX 1]–[AUX 5] buttons to select the desired Sends (A–E).

The selected button indicators light up. Send pre/post status can be viewed in Channel Display or Meter Display mode by pressing and holding down the [AUX1]–[AUX5] buttons.

### 2 Press the Encoder push-switches for the desired channels.

Pressing the Encoder push-switches repeatedly toggles between pre and post.

You can set Sends as pre or post by pressing the Encoder push-switches if faders, Encoders, and [ON] buttons are in Flip mode. See page 218 for more information.

## Setting Send Levels

You can adjust Pro Tools Send (A–E) send levels as follows.

- 1 **Press the AUX SELECT [AUX 1]–[AUX 5] buttons to select the desired Sends (A–E).**
- 2 **Rotate the Encoders for the desired channels.**

You can set Send levels by rotating the Encoders if faders, Encoders, and [ON] buttons are in Flip mode. Refer to “Flip Mode” for more information.

## Muting Sends A–E

You can mute Sends by pressing the [ON] buttons if faders, Encoders, and [ON] buttons are in Flip mode. Refer to “Flip Mode” for more information.

## Panning Sends A–E

You can pan only Sends assigned to stereo destinations by rotating the Encoders if faders, Encoders, and [ON] buttons are in Flip mode. Refer to the next section for more information.

## Flip Mode

In Flip mode, you can use the faders, Encoders, and [ON] buttons to control send levels, pre/post positions, and mute settings as shown in the following table.

Control	Normal mode	Flip Mode
Faders	Channel level	Send level
Encoders	Channel pan/send level	Send pan
Encoder push-switches	Encoder mode is Pan: inactive; Encoder mode is Send level: Send pre/post	Send pre/post
[ON] buttons	Channel mute	Send mute

- 1 **Press the FADER MODE [FADER/AUX] button.**  
The FADER MODE [FADER] and [AUX] indicators flash alternately, and the SELECT ASSIGN parameter on the display indicates “FLIP.”
- 2 **Press the AUX SELECT [AUX 1]–[AUX 5] buttons to select the desired Sends (A–E).**  
The button indicator of the selected send lights up.
- 3 **Use the faders, Encoders, and [ON] buttons to control the currently-selected send.**

For stereo Aux input channels, you can set the left and right panpots individually. To do this, press the ENCODER MODE [PAN] button repeatedly. When the button indicator is lit continuously, you can set the left panpot. When the button indicator is flashing, you can set the right panpot.

## Assigning Plug-ins to Pro Tools Channels

You can assign plug-ins to five inserts available for Pro Tools channel strips as follows.

- 1 Press the [F2] button to select Insert Display mode.
- 2 Press the AUX SELECT [AUX 8] button.

The [AUX 8] button indicator flashes. You can now select a channel to which you want to insert plug-ins.

- 3 Press the [SEL] button of each desired channel.
- 4 Make sure that the INSERT button (①) is selected in the INSERT ASSIGN/EDIT section.

If the PARAM button is selected instead, move the cursor to the button, then press [ENTER] to select INSERT.

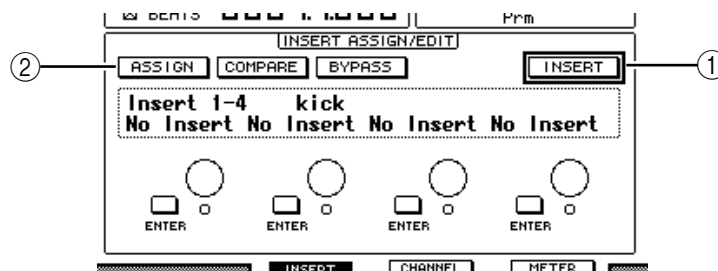

- 5 Move the cursor to the ASSIGN button (②), then press [ENTER] to turn on the button.

You can now select plug-ins. If you press another channel's [SEL] button after you turn on the ASSIGN button, the button turns off. If you wish to assign plug-ins to other channels, turn on the ASSIGN button again.

- 6 Move the cursor to one of the four parameter controls, then rotate the Parameter wheel to select a plug-in.

By default, the parameter controls enable you to select plug-ins to be assigned to channel inserts #1–#4. To assign a plug-in to insert #5, press the Tab Scroll button [►] to change the indication in the INSERT ASSIGN/EDIT section.

If you are using the TDM system, you can also assign outboard effects processors.

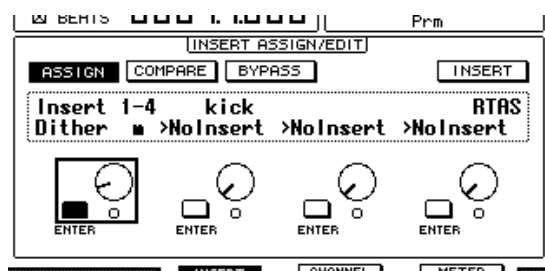

- 7 Press [ENTER] to confirm the assignment.  
Repeat Steps 6 and 7 to assign more plug-ins to other insert positions in the channel strip.
- 8 In the same way, assign plug-ins to other channels.
- 9 When you finish assigning plug-ins, press the [AUX 8] button.  
The button indicator turns off.

## Editing Plug-ins

You can edit plug-ins inserted in the channel strips as follows:

- 1 Press the [F2] button to select Insert Display mode.
- 2 Press the corresponding [SEL] button to select the channel that was assigned the plug-in you want to edit.
- 3 In the INSERT ASSIGN/EDIT section, move the cursor to the parameter control (Insert 1–4) that was assigned the parameter you want to edit.

**Note:** To adjust a plug-in assigned to insert #5, press the Tab Scroll button [▶] to change the parameter indication in the INSERT ASSIGN/EDIT section, then select a parameter control.



- 4 Press [ENTER] to display the parameters.

In the INSERT ASSIGN/EDIT section, the PARAM button is automatically selected and the Information box indicates the selected plug-in parameters.

You can now use parameter controls 1–4 and the [ENTER] button to adjust the parameters.

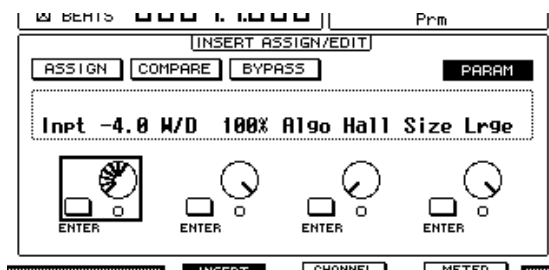

- 5 Use the Tab Scroll buttons to display the parameter value you wish to change.

Most plug-ins feature five or more parameters. To edit the fifth or subsequent parameters, use the Tab Scroll buttons to display the desired parameters and their values in the INSERT ASSIGN/EDIT section. The current page number and the plug-in name appear for a moment immediately after you press the Tab Scroll buttons.

- 6 Move the cursor to a parameter control, then rotate the Parameter wheel or press the [ENTER] button to adjust the value.

One or two parameters are assigned to a single parameter control. To turn the parameter setting on or off, press [ENTER]. To modify the parameter variable, rotate the Parameter wheel.

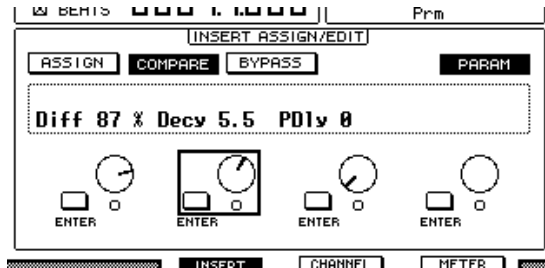

- 7 When you finish adjusting the parameters, move the cursor to the PARAM button, then press [ENTER] to switch it to INSERT.

## Bypassing Plug-ins

You can bypass plug-ins assigned to Pro Tools channels.

Before bypassing plug-ins, you must press the corresponding [SEL] button to select a channel to which the plug-ins have been assigned, then press the [F2] button to select Insert Display mode.

To bypass plug-ins, display the parameters of the plug-in you wish to bypass in the INSERT ASSIGN/EDIT section, then turn on the BYPASS button.

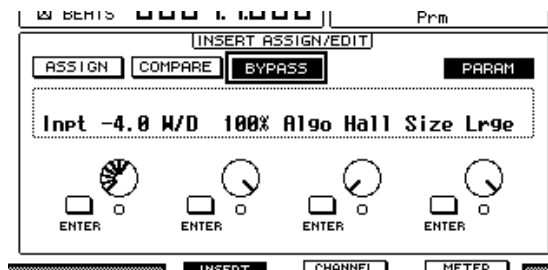

## Scrub & Shuttle

By assigning the **DAW SCRUB** parameter to one of the User Defined buttons [1]–[12], you can scrub Pro Tools tracks back and forth by turning the Parameter wheel. By assigning the **DAW SHUTTLE** parameter to one of the User Defined buttons [1]–[12], you can shuttle back and forth by turning the Parameter wheel.

**1 Assign the DAW SCRUB or DAW SHUTTLE parameter to one of the User Defined buttons [1]–[12].**

Before assigning parameters to these buttons, you must switch layers to cancel the Remote function. See page 257 for more information on assigning the parameters to the User Defined buttons.

**2 Press the LAYER [REMOTE 1] or [REMOTE 2] button to enable remote control of Pro Tools.**

**3 Make sure that Pro Tools is stopped.**

**4 Press the User Defined button to which you assigned the DAW SCRUB or DAW SHUTTLE parameter in Step 1.**

You can now use the Scrub or Shuttle function.

**5 Rotate the Parameter wheel.**

Rotate the Parameter wheel clockwise to scrub or shuttle forwards. Turn it counterclockwise to scrub or shuttle backwards.

The minimum scrub playback step varies depending on the zoom setting in the Pro Tools Edit window.

**6 To cancel the Scrub or Shuttle function, press the User Defined button to which you assigned the DAW SCRUB or DAW SHUTTLE parameter in Step 1.**

Alternatively, you can cancel the Scrub or Shuttle function by pressing the User Defined button to which the DAW STOP parameter is assigned. The Scrub or Shuttle function is automatically cancelled if you commence playback or fast forward.

**Note:** *The Scrub/Shuttle operation might be stopped unexpectedly by Pro Tools. Therefore, whenever you use the Scrub or Shuttle function, make sure that the P.WHEEL MODE parameter indicates “SCRUB” or “SHUTTLE.” You can check the Scrub/Shuttle function status by viewing the corresponding User Defined button indicator.*

## Automation

You can view the Pro Tools Automation mode as follows:

- 1 Press the [F3] or [F4] button to display the channels for remote control.
- 2 Press the DISPLAY ACCESS [AUTOMIX] button.

The channel's Automation settings are displayed.

While the STEREO [AUTO] button is on, the channel [SEL] button indicators also display the channel's Automation mode.

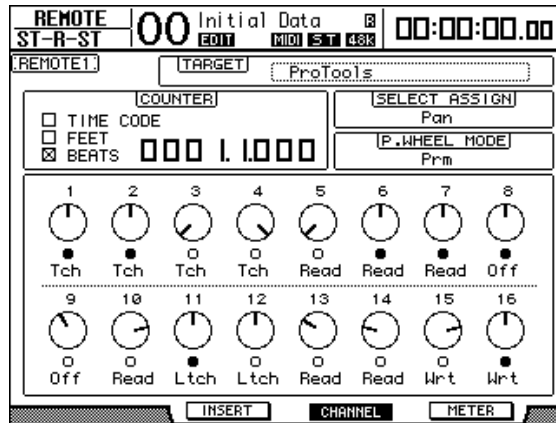

Pro Tools	Display	[SEL] Button Indicators
Auto write	Wrt	Flashing red (Record Ready) Red (Recording)
Auto touch	Tch	
Auto latch	Ltch	
Auto read	Read	Green
Auto off	Off	Off

**Tip:** If you assign the parameter that controls Automation to one of the User Defined buttons, you can control the Automation settings by holding down the programmed User Defined button and pressing the [SEL] button of the target channel. See page 257 for more information on assigning parameters to User Defined buttons.

## Nuendo Remote Layer

You can remotely control Nuendo using Remote Layers 1 and 2.

### ■ Configuring Computers

- 1 **Connect the DM1000 to your computer using a USB cable, and install the required USB driver included on the DM1000 CD-ROM.**

Refer to the Studio Manager installation guide for more information on installing the driver.

- 2 **Launch Nuendo, select the Device Setup menu, and set up Nuendo so that the DM1000 can communicate with the software.**

Refer to the Nuendo User's Manual for more information on setting up the software.

### ■ Configuring the DM1000

- 1 **Refer to page 208 to configure the Setup | MIDI/HOST page.**
- 2 **Press the LAYER [REMOTE 1] or [REMOTE 2] button to set the TARGET parameter to Nuendo.**

You can now remotely control Nuendo using the selected Remote Layer.

## Other DAW Remote Layers

You can remotely control DAW software that supports the Pro Tools protocol.

### ■ Configuring Computers

- 1 **Connect the DM1000 to your computer using a USB cable, and install the required USB driver included on the DM1000 CD-ROM.**

Refer to the Studio Manager installation guide for more information on installing the driver.

- 2 **Launch and set up DAW software so that the DM1000 communicates with the software.**

Refer to the DAW software's user's manual for more information on setting up the software.

### ■ Configuring the DM1000

- 1 **Refer to page 208 to configure the Setup | MIDI/HOST page.**
- 2 **Press the LAYER [REMOTE 1] or [REMOTE 2] button to set the TARGET parameter to General DAW.**

You can now remotely control DAW software using the selected Remote Layer.



## MIDI Remote Layer

If you select USER DEFINED as the target for Remote Layer 1 or 2, you can remotely control the parameters of external MIDI devices (such as synthesizers and tone generators) by operating the channel Encoders, [ON] buttons, and faders to output various MIDI messages. (This is called MIDI Remote function.)

You can store MIDI messages assigned to the channel controls in four banks. When the DM1000 is shipped from the factory, it includes main MIDI settings in these banks, which you can quickly recall to use the MIDI Remote function.

If necessary, you can also assign other MIDI messages to the faders, [ON] buttons, or Encoders to remotely control the parameters of a connected MIDI device.

### Using the MIDI Remote Function

This section describes how to use Remote Layer 2 to recall and use the factory-preset MIDI Remote settings stored in the banks.

By default, the DM1000's four MIDI Remote banks (Banks 1–4) contain the following MIDI messages.

Bank	Usage	Control Function		
		Encoders	[ON] buttons	Faders
1	Panning and setting GM sound levels	Pan	—	Volume
2	Setting GM sound effect send levels/Adjusting volume levels	Effect Send	—	Volume
3	Panning and setting XG sound levels	Pan	—	Volume
4	Adjusting pan, mute, and levels for Cubase series mixer	Pan	Mute	Volume

- 1 Connect the DM1000's MIDI OUT port to the MIDI IN port of the MIDI device.

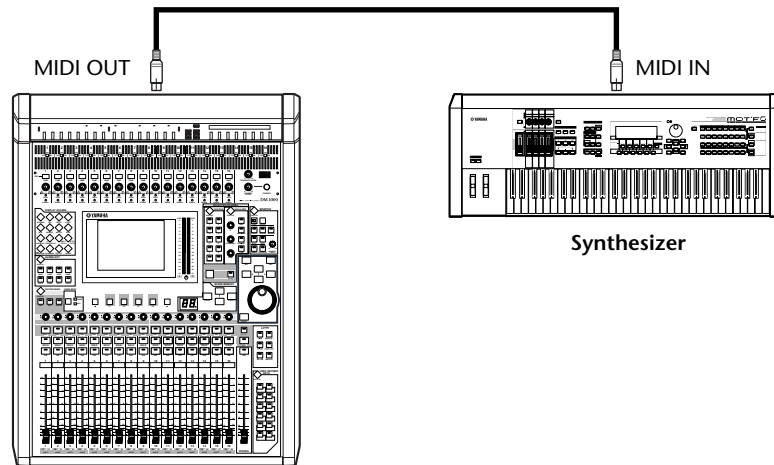

- 2 Press the DISPLAY ACCESS [SETUP] button repeatedly until the Setup | MIDI/Host page appears.

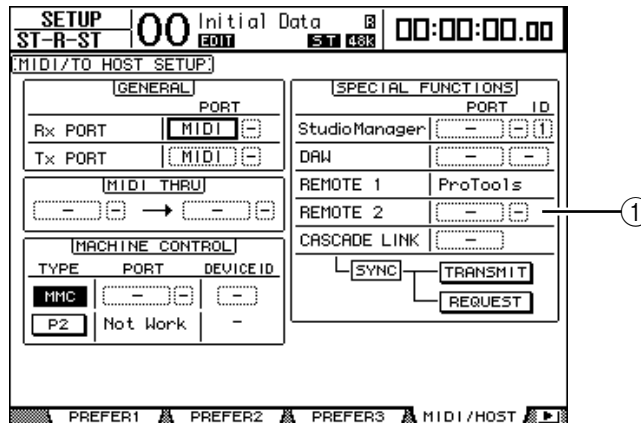

- 3 Move the cursor to the REMOTE 2 parameter box (①) in the SPECIAL FUNCTIONS section, rotate the Parameter wheel to select MIDI, then press [ENTER].

If the MIDI port is already in use, a confirmation window for changing the assignment appears. Move the cursor to the YES button, then press [ENTER].

*Tip: If the REMOTE 2 parameter box is grayed out, proceed to Steps 4 and 5 to set the TARGET parameter, then return to Steps 2 and 3.*

- 4 Press the DISPLAY ACCESS [REMOTE] button, then press the [F2] button.

The Remote | Remote 2 page appears.

- 5 Move the cursor to the TARGET parameter box, rotate the Parameter wheel to select USER DEFINED, then press [ENTER].

The confirmation window for changing the setting appears. Move the cursor to the YES button, then press [ENTER]. The display changes as follows:

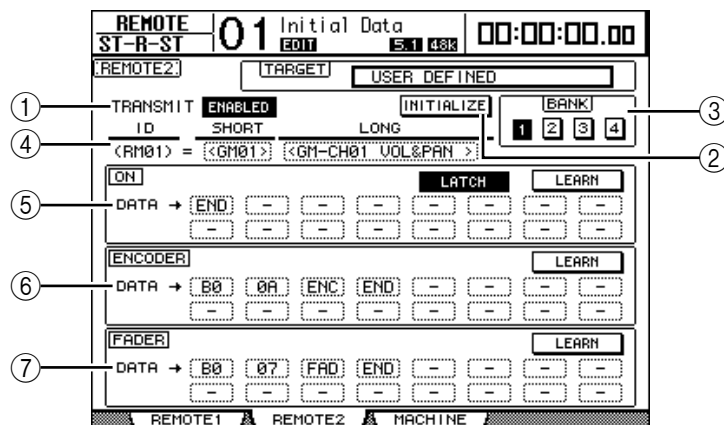

- ① **TRANSMIT ENABLE/DISABLE**  
This button switches the MIDI Remote function between enable and disable.
- ② **INITIALIZE**  
This button resets the settings stored in the bank selected by the BANK parameter to the default setting.
- ③ **BANK**  
This parameter enables you to select one of four banks.

**④ ID, SHORT, LONG**

These parameters display the channel names. The ID parameter displays the channel ID (RM01–RM16) for the currently-controlled MIDI device.

**⑤ ON section**

This section displays the type of MIDI messages (in hexadecimal or alphabet) assigned to the [ON] buttons for the currently-selected channels (RM01–RM16).

- **LATCH/UNLATCH.....** This button toggles between Latch and Unlatch for [ON] button operation.
- **LEARN.....** When you turn on this button, MIDI messages received at the MIDI IN port are assigned to the DATA parameter boxes.
- **DATA parameter boxes .....** These boxes display the type of MIDI messages (in hexadecimal or alphabets) assigned to the [ON] button).

**⑥ ENCODER section**

This section displays the type of MIDI messages (in hexadecimal or alphabet) assigned to the Encoders for the currently-selected channels (RM01–RM16).

**⑦ FADER section**

This section displays the type of MIDI messages (in hexadecimal or alphabet) assigned to the faders for the currently-selected channels (RM01–RM16).

- 6 Move the cursor to the desired bank button (BANK parameter buttons 1–4), then press [ENTER].**
- 7 Press the LAYER [REMOTE 2] button to select Remote Layer 2.**  
You can now use the MIDI Remote function.
- 8 Use the faders, Encoders, and [ON] buttons to control the MIDI device.**

## Assigning MIDI Messages to Channel Controls

You can quickly use the MIDI Remote function if you use the factory presets in the banks. However, you can also assign the desired MIDI messages to the faders, [ON] buttons, or Encoders.

This section describes how to assign MIDI messages to the channel controls, using the example of assigning Hold On/Off messages (Control Change #64; Values 127 & 0) to the Channel 1 [ON] button.

- 1 **Connect the DM1000's MIDI IN port to the MIDI OUT port of a MIDI keyboard to which a Hold On/Off controllable foot switch is connected. Enable the MIDI Remote function on the DM1000.**

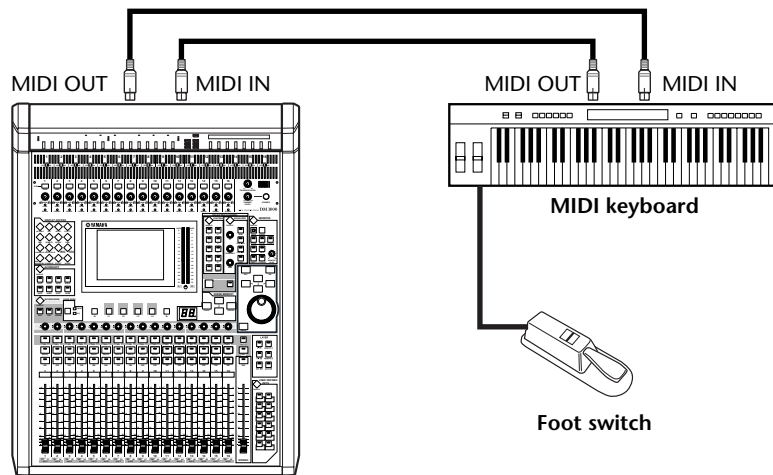

- 2 **Press the DISPLAY ACCESS [REMOTE] button, then the [F2] button to display the Remote | Remote 2 page. Rotate the Parameter wheel to set the TARGET parameter to USER DEFINED.**

You can now use the MIDI Remote function. Refer to the previous section for more information on using the MIDI Remote function.

- 3 **Move the cursor to the desired bank button (BANK parameter buttons 1–4), then press [ENTER].**
- 4 **Press the [SEL] buttons for the desired channels.**

Currently-assigned MIDI messages appear in the ON, ENCODER, and FADER sections.

*Tip:* You can also choose the desired channels using the ID, SHORT, and LONG parameters.

- 5 **Move the cursor to the LEARN button in the ON section, then press [ENTER].** MIDI messages received at the MIDI IN port of the DM1000 will be assigned to the DATA parameter boxes in the ON section.

**6 Press and hold down the MIDI keyboard foot switch.**

The MIDI Hold On message is assigned in the DATA parameter box.

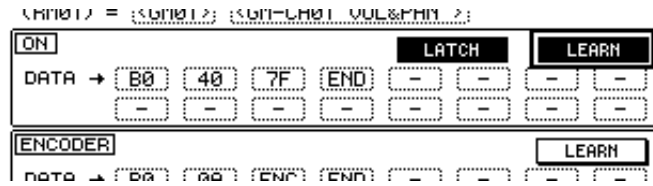

MIDI messages are described below:

- **00–7F** .....MIDI messages are expressed in hexadecimal.
- **END** .....This message indicates the end of MIDI messages. Subsequent messages assigned in the DATA parameter boxes will be ignored.
- **-** .....This message indicates that no messages are assigned to the DATA parameter boxes.

**Tip:** When you click the LEARN button to assign MIDI messages, the DM1000 automatically recognizes the end of the messages and assigns END and “-.”

**7 While continuing to hold down the foot switch, turn off the LEARN button.**

**8 Move the cursor to the third parameter box (“7F” in this example), then rotate the Parameter wheel to change the value to SW.**

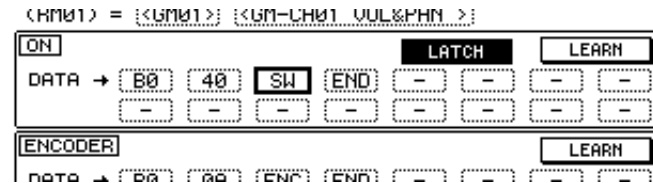

“SW” is a variable that changes depending on the [ON] button’s on/off status. You can use the following variables in MIDI messages.

- **SW** .....This variable is selectable only in the DATA parameter boxes of the ON section. When the [ON] buttons are turned on, “7F” (127 in decimal) is output. When the [ON] buttons are turned off, “00” (0 in decimal) is output.
- **ENC**.....This setting is selectable only in the DATA parameter boxes of the ENCODER section. When you operate the Encoders, values in the range of 00 to 7F (0–127 in decimal) are output.
- **FAD** .....This setting is selectable only in the DATA parameter boxes of the FADER section. When you operate the faders, values in the range of 00 to 7F (0–127 in decimal) are output.

**Tip:** If “SW” is not assigned in the DATA parameter boxes of the ON section, the current MIDI messages are output.

**Note:** Be sure to set variables in the ENCODER and FADER sections. If no variables are assigned, operation of the Encoders or faders is ignored.

**9 Move the cursor to the LATCH/UNLATCH button, then press [ENTER] to select LATCH or UNLATCH depending on how you want the [ON] buttons to function.**

- **LATCH** ..... Pressing the [ON] buttons repeatedly transmits alternating On and Off messages.
- **UNLATCH**..... Pressing and holding down the [ON] buttons transmits On messages, and releasing the [ON] buttons transmits Off messages.

**Tip:** Refer to the diagrams below for information on how the [ON] buttons behave when Latch or Unlatch is selected.

**■ When “SW” is assigned:**

- LATCH

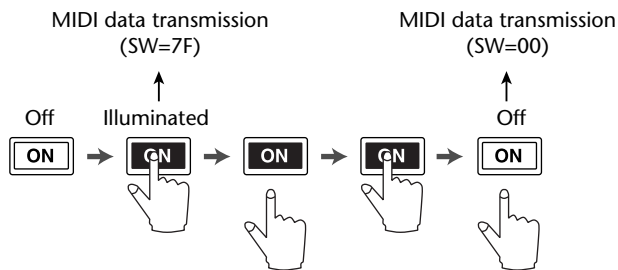

- UNLATCH

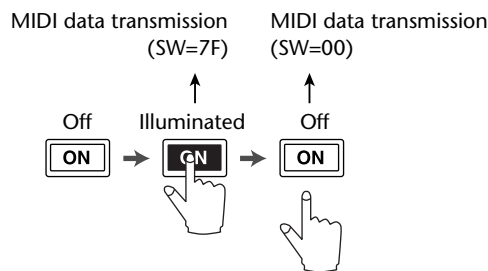

**■ When “SW” is not assigned:**

- UNLATCH

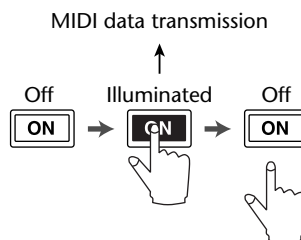

**Tip:** In most situations, select Unlatch if SW is not assigned.

**10 To change the channel name, move the cursor to the ID LONG parameter box, then press [ENTER] to display the Title Edit window.**

See page 30 for more information on editing names.

**Tip:**

- Move the cursor to the INITIALIZE button, then press [ENTER]. A window is displayed that enables you to reset the parameter settings in the currently-selected bank.
- You can also assign MIDI messages to the parameter boxes manually without using the LEARN button.

## Machine Control Function

The DM1000 can control the transport functions and select tracks on external recording machines that support MMC and the P2 protocol by transmitting commands via the MIDI OUT port and REMOTE connector respectively.

**Tip:** P2 protocol is used by Tascam DA-98HR and other professional video machines. The DM1000 is capable of transmitting P2 protocol commands via the REMOTE connector.

**Note:** Controllable parameters vary depending on the connected devices. Refer to the User's Manual for the external device for more information on controllable parameters.

- 1 Refer to the diagram below for information on connecting the DM1000 to an external device.

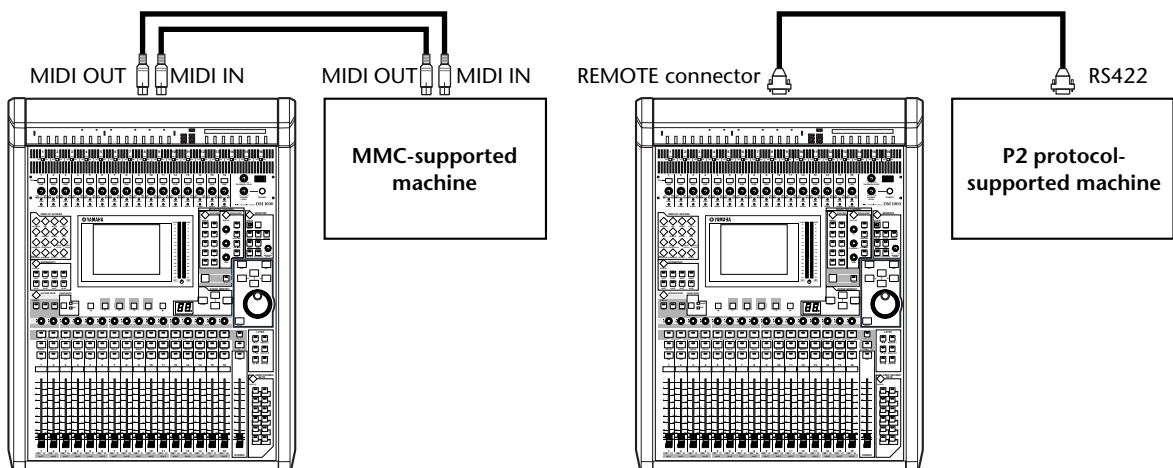

- 2 To control a device that supports the P2 protocol, press the DISPLAY ACCESS [SETUP] button repeatedly to display the Setup | Remote page, then set the REMOTE FUNCTION parameter (①) to "P2-DFLT."

This page enables you to select the type of signals transmitted or received via the REMOTE connector. See page 270 for more information.

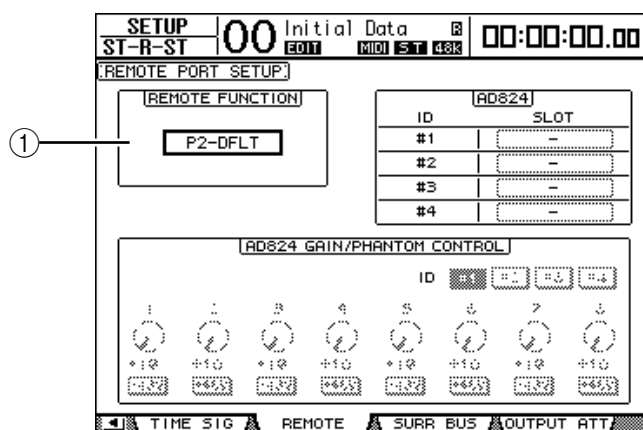

**Tip:** For the REMOTE FUNCTION parameter, you can also select P2-VTR1, P2-VTR2, or P2-VTR3 as a P2 protocol format. These three options are provided to support future P2 protocol supporting devices. Currently, they are identical to P2-DFLT.

- 3 Press the DISPLAY ACCESS [SETUP] button repeatedly until the Setup | MIDI/Host page appears.

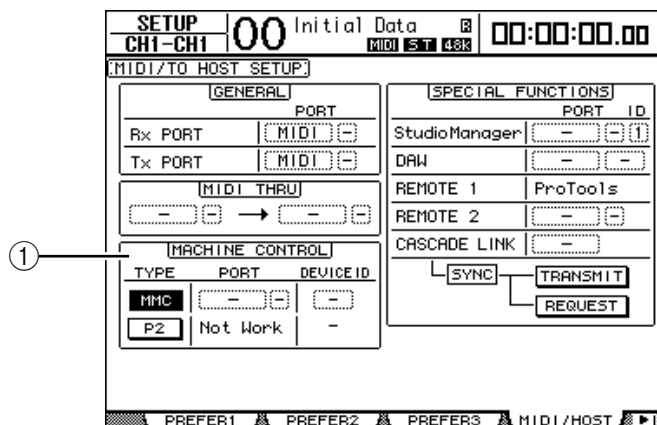

- 4 Move the cursor to either the MMC button or P2 button in the MACHINE CONTROL section (①) to specify the remote control method, then press the [ENTER] button.

In the MACHINE CONTROL section, you can also select the type of commands used on the Remote | Machine Control page. The MMC button selects MMC commands, and the P2 button select the P2 protocol.

- 5 If the MMC button is turned on, press the cursor [▶] button to move the cursor to the PORT parameter box, then rotate the Parameter wheel to select the MMC destination.

The following ports and slots are available as the MMC destination.

- MIDI.....MIDI port
- USB.....USB port
- SLOT1.....Slot 1 with an MY8-mLAN (mLAN card) installed
- REMOTE.....REMOTE connector

If USB or SLOT 1 is selected, move the cursor to the adjacent parameter box (on the right), and select one of eight ports.

- 6 Move the cursor to the DEVICE ID parameter box, then rotate the Parameter wheel to set the DM1000 MMC Device ID to the same ID number as the external device.

MMC commands are effective on devices that use the same Device ID. Therefore, the DM1000's MMC Device ID needs to match the ID of the devices you wish to control.



- 7 To start remote control, press the DISPLAY ACCESS [REMOTE] button, then press the [F3] button to display the Remote | Machine page.

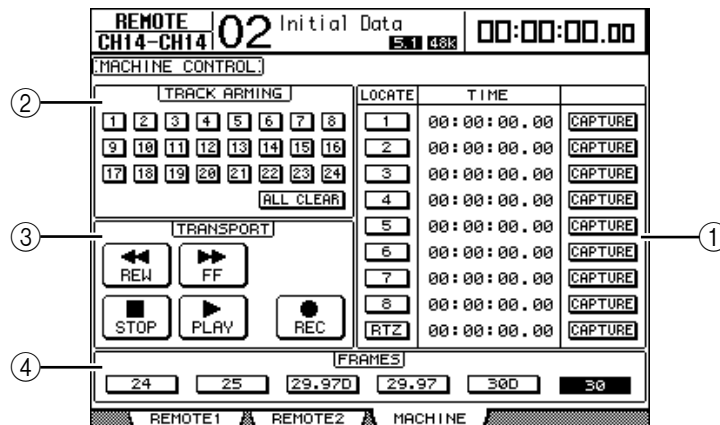

This page contains the following parameters:

① **LOCATE/TIME section**

This section enables you to set the locate points.

- **LOCATE 1–8**..... These buttons locate the positions (specified by the TIME values) on external machines.
- **RTZ**..... This Return To Zero button locates the zero timecode position on external machines.
- **TIME**..... Locate points are specified in hour/minute/second/frame format.
- **CAPTURE**..... These buttons capture the current position on external machines and import the information into the TIME column.

② **TRACK ARMING section**

This section controls the tracks on external machines.

- **1–24 buttons**..... These buttons turn external tracks 1–24 on or off, and set or cancel their Record Ready mode.
- **ALL CLEAR**..... Turning on this button switches all buttons (1–24) simultaneously.

③ **TRANSPORT section**

This section enables you to control the transport functions on external machines.

- **REW**..... This button starts rewind on external machines.
- **FF**..... This button starts fast forward on external machines.
- **STOP**..... This button stops external machines.
- **PLAY**..... This button starts playback on external machines.
- **REC**..... This button is used in conjunction with the PLAY button to start recording on external machines.

④ **FRAMES**

This parameter selects the timecode frame rate.

- 8 To control the transport functions, move the cursor to the desired button in the TRANSPORT section, then press [ENTER].
- 9 If you desire, move the cursor to the buttons and parameters in the LOCATE/TIME section and the TRACK ARMING section, then press the [ENTER] button or rotate the Parameter wheel to control the transport functions on external machines.



# 18 MIDI

This chapter describes the DM1000's MIDI-related functions.

## MIDI & the DM1000

**Using Control Changes, Program Changes, and other MIDI messages enables you to recall Scenes and edit parameters on the DM1000, and store DM1000 internal data on external MIDI devices.**

The DM1000 supports the following MIDI messages. Each of these MIDI messages can be individually turned on or off for transmission and reception.

- **Program Changes**

If you assign the DM1000's Scenes to Program Change numbers, the DM1000 transmits Program Changes when it recalls Scenes. Also, the DM1000 will switch Scenes when it receives Program Changes.

- **Control Changes**

If you assign the DM1000's parameters to Control Change numbers, the DM1000 transmits the assigned Control Changes when the parameter values change. Also, the DM1000 changes certain parameter values when it receives the corresponding Control Changes.

- **System Exclusive Messages**

The DM1000 transmits System Exclusive Parameter Changes in real-time when the parameter values change. Also, the DM1000 notifies certain parameter values when it receives assigned Parameter Changes.

- **MTC (MIDI Timecode)**

The DM1000 uses MTC to synchronize Automix with a recorder or computer-based sequencer.

- **MIDI Clock**

The DM1000 uses MIDI Clock to synchronize Automix with a MIDI device that does not support MTC.

- **MMC (MIDI Machine Control)**

MMC is used for external machine control.

- **MIDI Note On/Off**

These messages are used to adjust the Freeze effect and Auto Pan 5.1.

- **Bulk Dump Messages**

These messages enable you to store the DM1000's internal data to a sequencer or MIDI filer. When the DM1000 receives these messages, they overwrite the DM1000 data

The DM1000 features the following interface for transmitting and receiving MIDI data.

- **MIDI IN & OUT ports**

These ports transmit and receive MIDI data to and from standard MIDI devices. Each port is a single port interface that transmits and receives single-port data (16 channels x 1 ports).

- **USB port**

This port is used to connect a computer and transfer MIDI messages. This is a multiport interface that transmits and receives up to eight-port data (16 channels x 8 ports). If you connect a computer to the USB port, you must install the appropriate driver software on the computer. See the Studio Manager Installation Guide for more information on installing drivers.

*Note:* If the computer is turned on but the USB MIDI application has not been launched, DM1000 performance may be slow. In this case, cancel the assignment of the USB port as the MIDI message transmission port.

- **REMOTE connector**

This connector normally enables you to remotely control a Yamaha AD824 or a device that supports Sony P2 protocol, or to make a cascade connection with another DM1000. It also enables you to transfer MIDI messages.

To transfer MIDI messages, you need to set the parameters in the GENERAL section on the Setup | MIDI/Host page to “MIDI” (see “Tx PORT”).

Note that a connection between the REMOTE connector and a computer’s COMM port does not transfer MIDI messages.

- **SLOT 1**

If an optional “MY8-mLAN” I/O card is installed in Slot #1, MIDI data transfer to and from an external MIDI device is available via the MY8-mLAN card. Up to eight-port MIDI data (16 channels x 8 ports) can be transmitted and received.

## MIDI Port Setup

### Selecting a Port for MIDI Message Transfer

To configure MIDI ports for MIDI message transfer, press the DISPLAY ACCESS [SETUP] button repeatedly until the Setup | MIDI/Host page appears. This page enables you to set MIDI message input and output.

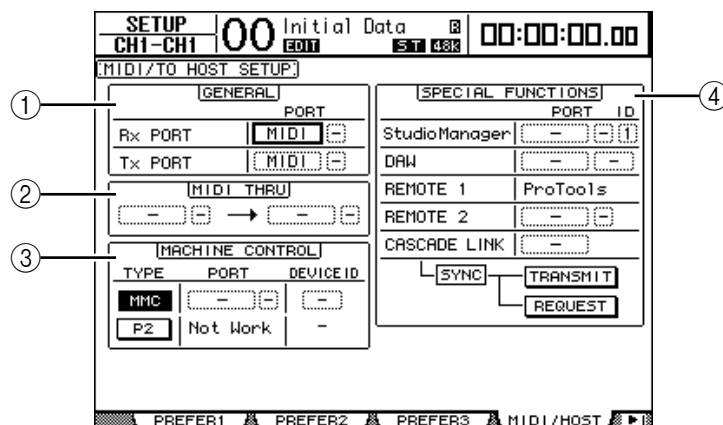

The following parameters are available on this page:

① **GENERAL section**

This section enables you to select ports that transmit and receive MIDI messages, such as Program Changes and Control Changes.

- **Rx PORT** ..... This parameter specifies a port for general MIDI data reception. In the left parameter box, select MIDI, USB, or SLOT (available only with an optional mLAN card installed). If you select USB, specify the port number in the right parameter box.
- **Tx PORT**..... This parameter specifies a port for general MIDI data transmission. The available ports are the same as for the Rx PORT parameter.

### ② **MIDI THRU section**

These parameters enable you to route incoming MIDI data from one port to another without changes. Select a port for reception in the first parameter box, and select a port for transmission in the next parameter box (located to the right of the arrow). If you select USB, specify the port number in the small parameter box adjacent to the port parameter box.

### ③ **MACHINE CONTROL section**

This section enables you to select a remote control method and a remote control port to control external devices, including hard disk recorders and video equipment.

- **TYPE**..... Specify a type (method) of remote control by turning on either the MMC (MIDI Machine Control) button or the P2 (Sony P2 protocol) button.
- **PORT** ..... Select MIDI, USB, REMOTE, or SLOT (available only when an optional mLAN card is installed) for MMC command transfer. If you select USB, specify the port number in the right parameter box.
- **DEVICE ID** ..... Specify the DM1000's MMC Device ID. MMC Device IDs identify connected devices, enabling recognition during MMC transmission and reception.

### ④ **SPECIAL FUNCTIONS section**

This section enables you to specify ports for various special functions.

- **Studio Manager**..... In the left parameter box, select MIDI, USB, or REMOTE as the port used by the included Studio Manager software. In the two small parameter boxes on the right, specify a port number (if you selected USB), and an ID number.
- **DAW** ..... Select USB or REMOTE as a port for use with a DAW. If you select USB, specify in the right parameter box a port number pair (1–2, 3–4, 5–6, 7–8).
- **REMOTE 1** ..... This parameter indicates the target currently selected for Remote Layer 1. If the target is set to “USER DEFINED,” you can select a MIDI message destination port.
- **REMOTE 2** ..... This parameter indicates the target currently selected for Remote Layer 2. If the target is set to “USER DEFINED,” you can select a MIDI message destination port.
- **CASCADE LINK** ..... Select MIDI or REMOTE as a port for DM1000 cascade connection. Clicking the TRANSMIT button during cascade connection enables you to copy the internal settings of the DM1000 you are operating to another DM1000. This enables both DM1000s to share the identical parameter settings. Clicking the REQUEST button during cascade connection enables you to copy the internal settings of the other DM1000 to the DM1000 you are operating.

## Selecting MIDI Messages for Transmission and Reception

You can select MIDI messages to be transmitted or received at a port specified in the GENERAL section on the Setup | MIDI/Host page (see page 236).

To do so, press the DISPLAY ACCESS [MIDI] button repeatedly until the MIDI | Setup page appears.

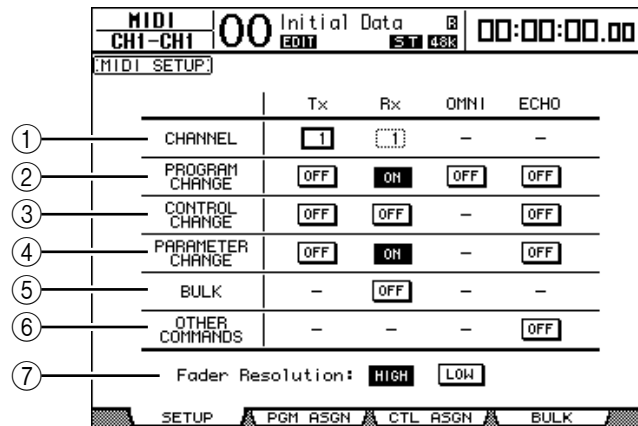

Select MIDI channels for transmission and reception in the CHANNEL row, and turn the transmission and reception of each MIDI message on or off using the buttons in the parameter rows from PROGRAM CHANGE to OTHER COMMANDS.

### ① CHANNEL

This parameter row enables you to specify MIDI Channels for MIDI message transmission and reception. The following parameters are available in this row:

- **Tx** ..... This parameter box specifies a MIDI Transmit Channel.
- **Rx** ..... This parameter box specifies a MIDI Receive Channel.

### ② PROGRAM CHANGE

This parameter row enables or disables transmission and reception of Program Changes.

- **Tx ON/OFF** ..... Transmission of Program Change messages is enabled or disabled.
- **Rx ON/OFF** ..... Reception of Program Change messages is enabled or disabled.
- **OMNI ON/OFF** ..... When this button is turned on, Program Changes on all MIDI Channels are received regardless of the CHANNEL row settings.
- **ECHO ON/OFF** ..... This button determines whether Program Change messages received at the MIDI IN port are echoed through to the MIDI OUT port.

### ③ CONTROL CHANGE

This parameter row enables or disables transmission and reception of Control Changes.

- **Tx ON/OFF** ..... Transmission of Control Change messages is enabled or disabled.
- **Rx ON/OFF** ..... Reception of Control Change messages is enabled or disabled.
- **ECHO ON/OFF** ..... This button determines whether Control Change messages received at the MIDI IN port are echoed through to the MIDI OUT port.

### ④ PARAMETER CHANGE

This parameter row enables or disables transmission and reception of Parameter Changes.

- **Tx ON/OFF** ..... Transmission of Parameter Change messages is enabled or disabled.
- **Rx ON/OFF** ..... Reception of Parameter Change messages is enabled or disabled.
- **ECHO ON/OFF** ..... This button determines whether Parameter Change messages received at the MIDI IN port are echoed through to the MIDI OUT port.

#### ⑤ BULK

This parameter row enables or disables reception of Bulk Dump data.

- **Rx ON/OFF** ..... Reception of Bulk Dump data is enabled or disabled.

#### ⑥ OTHER COMMANDS

- **ECHO ON/OFF** ..... This button determines whether other MIDI messages received at the MIDI IN port are echoed through to the MIDI OUT port.

#### ⑦ Fader Resolution

This parameter specifies the resolution of the value output when you operate the DM1000's faders. To transfer fader value data between two cascaded DM1000s, or to record the DM1000 operation to or play it back from a sequencer, select the HIGH button. When the LOW button is selected, the fader resolution switches to 256 steps.

## Assigning Scenes to Program Changes for Remote Recall

You can assign DM1000 Scenes to MIDI Program Changes for remote recall. When you recall a Scene on the DM1000, the unit transmits the assigned Program Change to the connected MIDI device. When the DM1000 receives a Program Change, the assigned Scene is recalled.

Initially, Scenes 1 through 99 are assigned sequentially to Program Changes 1 through 99, and Scene #0 is assigned to Program Change #100, although you can change these assignments.

**Tip:** You can store a Scene to Program Change assignment table to an external device by using MIDI Bulk Dump or included Studio Manager software.

- 1 Press the **DISPLAY ACCESS [SETUP]** button repeatedly until the **Setup | MIDI/Host** page appears, then specify ports for transmission and reception of MIDI messages (see page 236).
- 2 Make connections using the ports selected in Step 1 so that the DM1000 can transfer MIDI messages to and from the external device.
- 3 Press the **DISPLAY ACCESS [MIDI]** button, then press the **[F2]** button.

The **MIDI | Pgm Asgn** page appears.

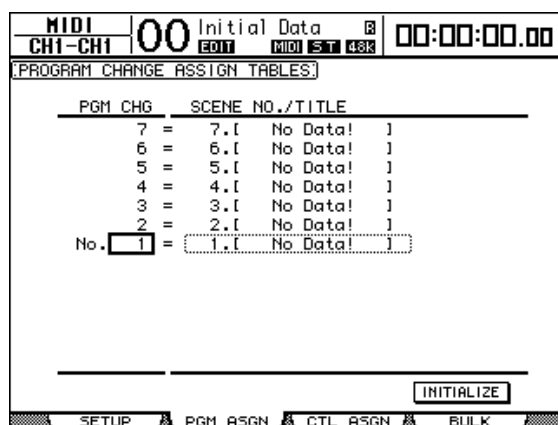

- 4 Move the cursor to a parameter box in the PGM CHG column, and rotate the Parameter wheel or press the [INC]/[DEC] buttons to select the Program Change numbers to which you want to assign Scenes.
- 5 Press the cursor button [▶] to move the cursor to a parameter box in the SCENE NO./TITLE column, then rotate the Parameter wheel or press the [INC]/[DEC] buttons to select Scenes.

**Tip:**

- If you assign a Scene to multiple Program Changes, the Program Change with the lowest number becomes effective.
- You can initialize the Scene to Program Change assignment table by moving the cursor to the INITIALIZE button, then pressing [ENTER].

- 6 Press the DISPLAY ACCESS [MIDI] button repeatedly until the MIDI | Setup page appears, then specify the MIDI Transmit and Receive Channels.
- 7 Turn on the PROGRAM CHANGE Tx ON/OFF and Rx ON/OFF buttons.

Now, when the DM1000 receives the Program Changes on the specified MIDI Channels, the corresponding Scenes are recalled. Also, when you switch Scenes on the DM1000, the DM1000 transmits the Program Changes on the specified MIDI Channels.

## Assigning Parameters to Control Changes for Real-time Control

You can assign DM1000 parameters to MIDI Control Changes for real-time control. When the DM1000 receives a Control Change, the assigned DM1000 parameter is set accordingly. Also, when you adjust a parameter on the DM1000, the DM1000 transmits the assigned Control Change message.

**Tip:** You can store a Parameter to Control Change assignment table to an external device by using MIDI Bulk Dump or included Studio Manager software.

- 1 Press the DISPLAY ACCESS [SETUP] button repeatedly until the Setup | MIDI/Host page appears, then specify ports for transmission and reception of MIDI messages (see page 236).
- 2 Make connections using the ports selected in Step 1 so that the DM1000 can transfer MIDI messages to and from the external device.
- 3 Press the DISPLAY ACCESS [MIDI] button, then press the [F3] button.

The MIDI | Ctl Asgn page appears. This page enables you to assign DM1000 parameters to Control Changes.

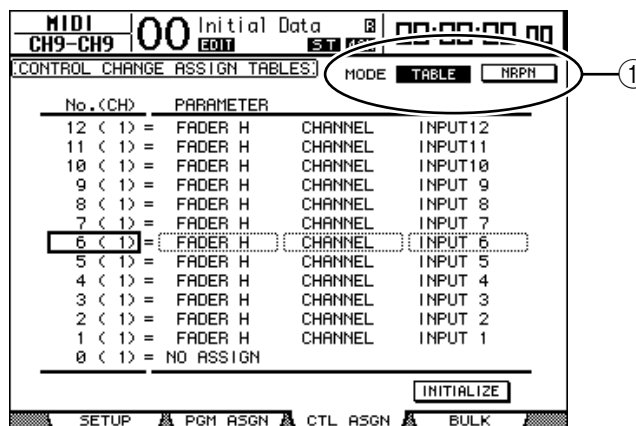

**Tip:** See page 337 for more information on the default Parameter to Control Change assignments.



**4 Move the cursor to the MODE parameter’s TABLE button (Ⓜ), then press [ENTER].**

The MODE parameter determines which MIDI messages are transmitted when DM1000 parameters are adjusted. The following options are available for the MODE parameter:

- **TABLE**.....MIDI Control Change messages are transmitted in accordance with the assignments on this page.
- **NRPN**.....The assignments on the Ctl Asgn page are ignored, and pre-defined NRPNs (Non Registered Parameter Numbers) are transmitted for remote control.

***Tip:** NRPNs are special MIDI messages that combine three different Control Changes. They enable you to control many parameters on a single MIDI Channel.*

**5 Move the cursor to a parameter box in the No. (CH) column, then rotate the Parameter wheel or press the [INC]/[DEC] buttons to select the Control Changes to which you want to assign parameters.**

You can assign parameters to up to 16-channel Control Changes on the Ctl Asgn page, regardless of the MIDI Channels currently selected for transmission and reception.

Skip Steps 5 and 6 if you turned on the NRPN button in Step 4.

**6 Select parameters in the parameter boxes in the three PARAMETER columns.**

Select a parameter group in the parameter box in the first PARAMETER column, and specify the desired values in the parameter boxes in the second and third PARAMETER columns.

The following parameters and values are available:

HIGH	MID	LOW
<b>NO ASSIGN</b>	—	—
<b>FADER H</b>	CHANNEL	INPUT1–48
	MASTER	BUS1–8/AUX1–8/STEREO
	AUX1 SEND	INPUT1–48
	AUX2 SEND	
	AUX3 SEND	
	AUX4 SEND	
	AUX5 SEND	
	AUX6 SEND	
	AUX7 SEND	
	AUX8 SEND	
	BUS TO ST	BUS1–8
<b>FADER L</b>	CHANNEL	INPUT1–48
	MASTER	BUS1–8/AUX1–8/STEREO
	AUX1 SEND	INPUT1–48
	AUX2 SEND	
	AUX3 SEND	
	AUX4 SEND	
	AUX5 SEND	
	AUX6 SEND	
	AUX7 SEND	
	AUX8 SEND	
	BUS TO ST	BUS1–8

HIGH	MID	LOW
ON	CHANNEL	INPUT1–48
	MASTER	BUS1–8/AUX1–8/STEREO
	AUX1 SEND	INPUT1–48
	AUX2 SEND	
	AUX3 SEND	
	AUX4 SEND	
	AUX5 SEND	
	AUX6 SEND	
	AUX7 SEND	
	AUX8 SEND	
	BUS TO ST	BUS1–8
PHASE	CHANNEL	INPUT1–48
INSERT ON	CHANNEL	INPUT1–48
	MASTER	BUS1–8/AUX1–8/STEREO
PRE/POST	AUX1 SEND	INPUT1–48
	AUX2 SEND	
	AUX3 SEND	
	AUX4 SEND	
	AUX5 SEND	
	AUX6 SEND	
	AUX7 SEND	
	AUX8 SEND	
IN DELAY	ON	INPUT1–48
	TIME HIGH	
	TIME MID	
	TIME LOW	
	MIX HIGH	
	MIX LOW	
	FB GAIN H	
	FB GAIN L	
OUT DELAY	ON	BUS1–8/AUX1–8/STEREO L, R
	TIME HIGH	
	TIME MID	
	TIME LOW	

HIGH	MID	LOW
EQ	ON	INPUT1-48/BUS1-8/AUX1-8/STEREO
	Q LOW	
	F LOW	
	G LOW H	
	G LOW L	
	Q LO-MID	
	F LO-MID	
	G LO-MID H	
	G LO-MID L	
	Q HI-MID	
	F HI-MID	
	G HI-MID H	
	G HI-MID L	
	Q HIGH	
	F HIGH	
	G HIGH H	
	G HIGH L	
	ATT H	
	ATT L	
	HPF ON	
LPF ON		
GATE	ON	INPUT1-48
	ATTACK	
	THRESH H	
	THRESH L	
	RANGE	
	HOLD H	
	HOLD L	
	DECAY H	
	DECAY L	
COMP	ON	INPUT1-48/BUS1-8/AUX1-8/STEREO
	ATTACK	
	THRESH H	
	THRESH L	
	RELEASE H	
	RELEASE L	
	RATIO	
	GAIN H	
	GAIN L	
	KNEE	
PAN	CHANNEL	INPUT1-48
	AUX1-2	
	AUX3-4	
	AUX5-6	
	AUX7-8	
BUS TO ST	BUS1-8	
BALANCE	MASTER	STEREO

HIGH	MID	LOW
SURROUND	LFE H	INPUT1-48
	LFE L	
	DIV (F)	
	DIV R	
	LR	
	FR	
	WIDTH	
	DEPTH	
	OFS LR	
	OFS FR	
	EFFECT	
MIX		
PARAM1 H		
PARAM1 L		
:		
PARAM32 H		
PARAM32 L		

Parameters that feature a setting range of more than 128 steps (such as Fader and Delay Time parameters) require two or more Control Change messages to specify the values.

For example, if you wish to control Fader parameters on certain channels using Control Changes, you must assign the same channel to two Control Change numbers, and select “FADER H” and “FADER L” for the Control Changes in the parameter boxes in the first PARAMETER column.

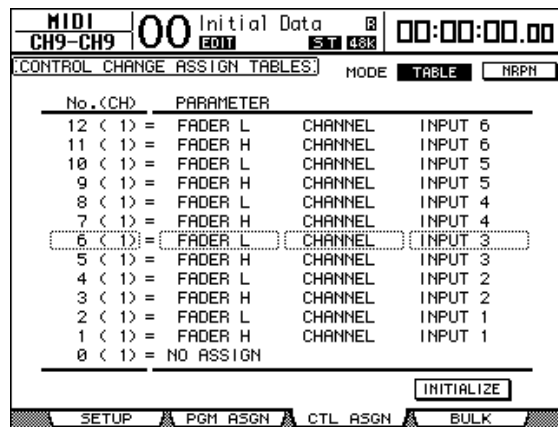

If you wish to control Delay Time parameters on certain channels using Control Changes, you must assign the same channel Delay parameter to three Control Change numbers, and select “TIME LOW,” “TIME MID,” and “TIME HIGH” for the Control Changes in the parameter boxes in the second (middle) PARAMETER column.

MIDI		Initial Data		00:00:00.00	
CH9-CH9		00		51 433	
CONTROL CHANGE ASSIGN TABLES					
MODE TABLE NRPN					
No. (CH)	PARAMETER				
12 ( 1)	= IN DELAY	TIME LOW	INPUT 4		
11 ( 1)	= IN DELAY	TIME MID	INPUT 4		
10 ( 1)	= IN DELAY	TIME HIGH	INPUT 4		
9 ( 1)	= IN DELAY	TIME LOW	INPUT 3		
8 ( 1)	= IN DELAY	TIME MID	INPUT 3		
7 ( 1)	= IN DELAY	TIME HIGH	INPUT 3		
6 ( 1)	= IN DELAY	TIME LOW	INPUT 2		
5 ( 1)	= IN DELAY	TIME MID	INPUT 2		
4 ( 1)	= IN DELAY	TIME HIGH	INPUT 2		
3 ( 1)	= IN DELAY	TIME LOW	INPUT 1		
2 ( 1)	= IN DELAY	TIME MID	INPUT 1		
1 ( 1)	= IN DELAY	TIME HIGH	INPUT 1		
0 ( 1)	= NO ASSIGN				

INITIALIZE

SETUP PGM ASGN CTL ASGN BULK

**Note:** Parameters that feature a setting range in excess of 128 steps require an appropriate combination of range parameters for successful MIDI Control Change.

**Tip:** You can initialize the Parameter to Control Change assignment table by moving the cursor to the INITIALIZE button, then pressing [ENTER].

- 7 Press the DISPLAY ACCESS [MIDI] button repeatedly until the MIDI | Setup page appears, then specify MIDI Transmit and Receive Channels.
- 8 Turn on the CONTROL CHANGE Tx ON/OFF and Rx ON/OFF buttons.

DM1000 parameters will now be set accordingly when the DM1000 receives corresponding Control Changes. Also, when you adjust parameters on the DM1000, the DM1000 will transmit corresponding Control Changes.

**Note:** Before controlling parameters using Control Changes, make sure that both Tx and Rx ON/OFF buttons in the PARAMETER CHANGE row are turned off.

## Controlling Parameters by Using Parameter Changes

You can control DM1000 parameters in real time by using Parameter Change messages that are System Exclusive messages, instead of using MIDI Control Changes.

See “MIDI Data Format” at the end of this Manual for detailed information on available Parameter Changes.

- 1 Press the **DISPLAY ACCESS [SETUP]** button repeatedly until the **Setup | MIDI/Host** page appears, then specify ports for transmission and reception of MIDI messages (see page 236).
- 2 Make connections using the ports selected in Step 1 so that the DM1000 can transmit and receive MIDI messages to and from the external device.
- 3 Press the **DISPLAY ACCESS [MIDI]** button repeatedly until the **MIDI | Setup** page appears, then turn off the Tx and Rx ON/OFF buttons in the **PARAMETER CHANGE** row.

The DM1000 will now set certain parameter values when it receives corresponding Parameter Changes. Also, when you adjust certain parameters on the DM1000, it transmits corresponding Parameter Changes.

*Note:* You do not have to specify MIDI Channels to control parameters using Parameter Changes. Make sure that both Tx and Rx ON/OFF buttons in the CONTROL CHANGE row on the MIDI | Setup page are turned off.

## Transmitting Parameter Settings via MIDI (Bulk Dump)

You can back up data stored in the DM1000, such as libraries and Scenes, to an external MIDI device by using MIDI Bulk Dump. In this way, you can later restore previous DM1000 settings by transmitting this MIDI data back to the DM1000.

- 1 Press the **DISPLAY ACCESS [SETUP]** button repeatedly until the **Setup | MIDI/Host** page appears, then specify ports for transmission and reception of MIDI messages (see page 236).
- 2 Make connections using the ports selected in Step 1 so that the DM1000 can transmit and receive MIDI messages to and from the external device.
- 3 Press the **DISPLAY ACCESS [MIDI]** button, then press the **[F4]** button.

*Note:* Some of the data transmitted from the DM1000 to the sequence software may occasionally drop out during Bulk Dump transmission. To avoid this, we recommend that you use the included Studio Manager software to store DM1000 data to an external device.

The MIDI | Bulk page appears.

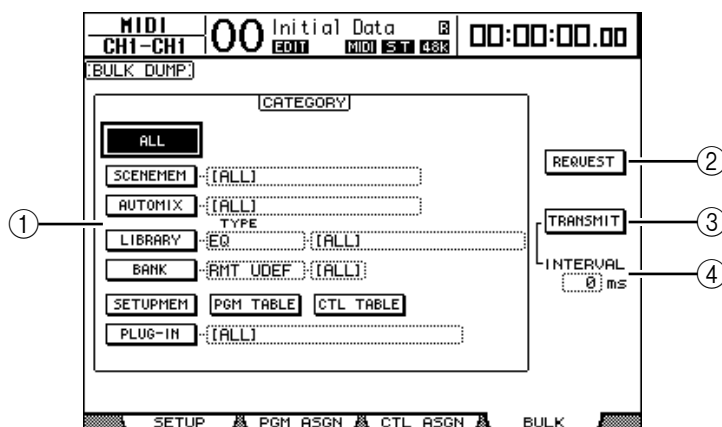

The page includes the following parameters:

① **CATEGORY section**

This section enables you to select data for transmission and reception.

② **REQUEST**

Move the cursor to this button, then press [ENTER] to transmit messages from the DM1000 that request a second DM1000 (connected to the first DM1000) to transmit the data specified in the CATEGORY section. This button is used primarily when two DM1000s are connected in cascade.

③ **TRANSMIT**

Move the cursor to this button, then press [ENTER] to transmit data specified in the CATEGORY section to an external MIDI device.

④ **INTERVAL**

This parameter specifies the interval between data packets during bulk transmission in 50 millisecond steps. If the external device drops part of the bulk data, increase this parameter value.

**4 In the CATEGORY section, move the cursor to the button of the data type you want to transmit, then press [ENTER].**

The following options are available:

- **ALL**..... This button selects all data available for bulk dump. When this button is turned on, all other buttons in this section are turned off.
- **SCENEMEM** ..... This button selects Scene memories. You can select Scenes you wish to transmit in the parameter box next to the button.
- **AUTOMIX** ..... This button selects Automix memories. You can select Automixes you wish to transmit in the parameter box next to the button.
- **LIBRARY**..... This button selects libraries. You can select the type of library in the TYPE parameter box (next to the button), then specify the library number in the parameter box on the right.
- **BANK**..... This parameter enables you to select the User Defined Key banks (KEYS UDEF), User Defined Remote Layer banks (RMD UDEF), or User Assignable Layer banks (USR LAYER) for bulk dump. You can select one of these three types in the parameter box next to the button, and select the banks in the parameter box on the right.

- **SETUPMEM**..... This button selects the DM1000 setup data (i.e., system settings).
- **PGM TABLE**..... This button selects the MIDI | Pgm Asgn page settings.
- **CTL TABLE**..... This button selects the MIDI | Ctl Asgn page settings.
- **PLUG-IN**..... This button selects the settings of any optional Y56K cards installed in Slot #1 or #2. You can select Y56K card programs in the parameter box next to the button.

***Note:** Data selected by the SETUPMEM button includes MIDI transmission and reception port settings and message settings. After you store to an external device bulk dump data that has its reception disabled, if the DM1000 later starts to receive this particular data, DM1000 bulk dump reception will be turned off immediately, and the DM1000 will be unable to receive subsequent data. Therefore, before you store the data selected by the SETUPMEM button using Bulk Dump, be sure to enable bulk data transmission and reception.*

- 5 **If necessary, move the cursor to the parameter box next to the selected button, then rotate the Parameter wheel or press the [INC]/[DEC] buttons to select the desired bulk dump data.**

***Tip:** If you selected [ALL] in the parameter box, all data selected by the corresponding button is transmitted as bulk dump data.*

- 6 **To start transmitting bulk data, move the cursor to the TRANSMIT button, then press [ENTER].**

Bulk Dump is executed. During the operation, the Bulk Dump window appears, indicating the current bulk dump status. To abort the bulk dump operation, move the cursor to the CANCEL button in the window, then press [ENTER].

***Tip:** To transmit bulk dump request messages, move the cursor to the REQUEST button, then press [ENTER]. If a second DM1000 is connected, it will transmit bulk data to the first DM1000 in response to the request.*

- 7 **To receive bulk data, press the DISPLAY ACCESS [MIDI] button repeatedly until the MIDI | Setup page appears, then turn on the Rx ON/OFF button in the BULK row.**

Now, when the DM1000 receives bulk data, the corresponding internal data is updated.



# 19 Other Functions

This chapter describes the DM1000's miscellaneous functions.

## Changing the Input and Output Connector Names

You can change the default name of the input and output connectors, if you desire.

### Changing the Input Connector Names

- 1 Press the DISPLAY ACCESS [SETUP] button repeatedly until the Setup | In Port page appears.

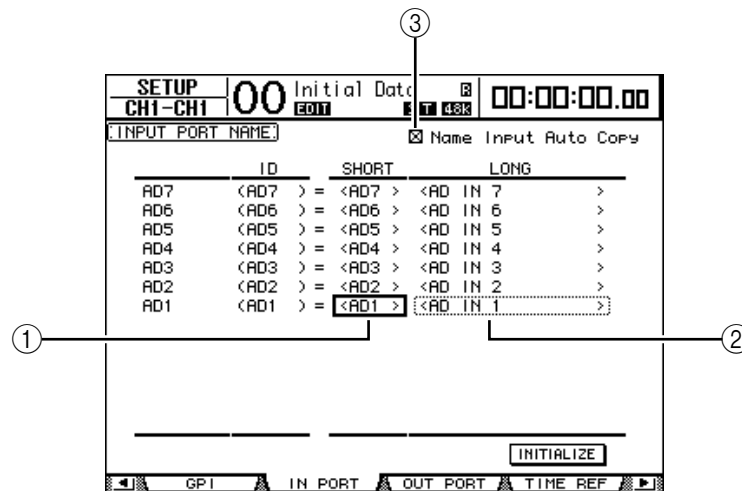

You can specify Short names in the parameter boxes (①) in the center column, and Long names in the parameter boxes (②) in the right column.

- 2 Use the Parameter wheel to select a port for which you want to change the name.
- 3 Move the cursor to a name you want to change, then press [ENTER].  
The Title Edit window appears, which enables you to edit the name.



- 4 Edit the name, move the cursor to the OK button, then press [ENTER].  
The new name is now effective.

**Tip:** The edited name is stored in the Input Patch library.

When the Name Input Auto Copy check box (③) is on, the first four characters of a newly-entered Long name are automatically copied to the Short name.

You can reset all port names to their default names by moving the cursor to the INITIALIZE button, then pressing [ENTER].

## Changing the Output Connector Names

To change output connector names, press the DISPLAY ACCESS [SETUP] button repeatedly until the Setup | Out Port page appears.

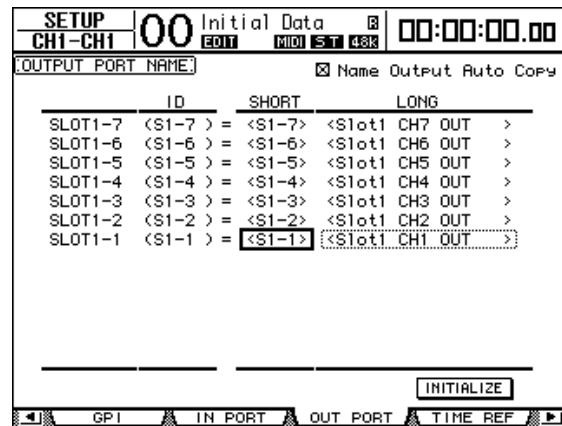

The procedure for editing the names and using the Name Output Auto Copy check box and the INITIALIZE button is the same as on the In Port page.

## Setting Preferences

You can change the default settings and environmental settings of the DM1000 by using the Setup | Prefer1, Prefer2, and Prefer3 pages. To locate one of the Preferences page, press the DISPLAY ACCESS [SETUP] button repeatedly.

### Prefer1 page

This page enables you to set the DM1000 so that when you press a button on the top panel, the DM1000 displays the corresponding display page, and shows or hides confirmation and alarm messages.

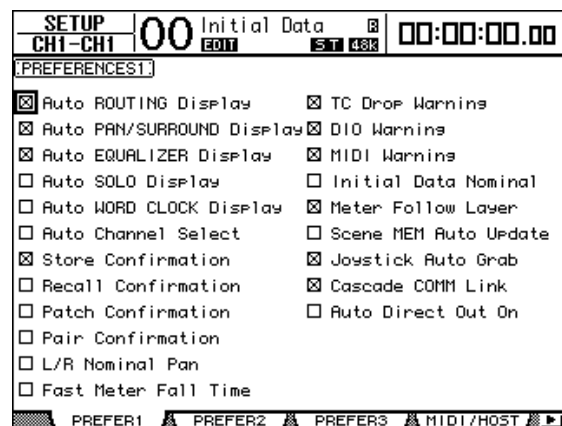

This page contains the following parameters. (These parameters are explained in the order from the top of the left column to the bottom of the right column.)

- **Auto ROUTING Display**

If this check box is on, the Routing pages appear automatically when you press a routing-related button in the SELECTED CHANNEL section.

- **Auto PAN/SURROUND Display**  
If this check box is on, the Pan/Surr pages appear automatically when you operate the Joystick in the SELECTED CHANNEL section. If you want to use the Joystick to adjust the pan setting, turn on this check box. In Stereo Surround mode, operating the Joystick enables you to adjust the Pan setting. Otherwise, it enables you to adjust the Surround Pan settings.
- **Auto EQUALIZER Display**  
If this check box is on, the EQ | EQ Edit page appears automatically when you press an EQ-related button in the SELECTED CHANNEL section.
- **Auto SOLO Display**  
If this check box is on, the Monitor | Solo C-R page appears automatically when you solo an Input Channel.
- **Auto WORD CLOCK Display**  
If this check box is on, the DIO | Word Clock page appears automatically if the currently-selected external wordclock source fails.
- **Auto Channel Select**  
If this check box is on, you can select a channel by moving the corresponding fader or Encoder, or by turning on the corresponding channel [SOLO], [ON], or [AUTO] button.
- **Store Confirmation**  
If this check box is on, the Title Edit window to input a Scene or library memory name appears when you store a Scene or library memory.
- **Recall Confirmation**  
If this check box is on, a confirmation window appears when you recall a Scene or library memory.
- **Patch Confirmation**  
If this check box is on, a confirmation message appears when you edit the Input and Output Patches.
- **Pair Confirmation**  
If this check box is on, the confirmation message appears when you create or cancel a pair.
- **L/R Nominal Pan**  
If this check box is on, left/odd and right/even signals will be at nominal level (0 dB) when Input Channels are panned hard left or hard right. If this check box is off, the signal level rises by +3 dB.
- **Fast Meter Fall Time**  
If this check box is on, the level meters fall more quickly.
- **TC Drop Warning**  
If this check box is on, a warning message appears if a dropout is detected in the incoming timecode.
- **DIO Warning**  
If this check box is on, a warning message appears when any errors are detected in digital audio signals received at the Slot 1 or 2, or 2TR Digital Inputs.
- **MIDI Warning**  
If this check box is on, a warning message appears when any errors are detected in the incoming MIDI messages.

- **Initial Data Nominal**  
If this check box is on, Input Channel faders are set to nominal (0 dB) when you recall Scene #0.
- **Meter Follow Layer**  
If this check box is on, a connected optional MB1000 Meter Bridge automatically track a layer selection made in the LAYER section on the DM1000.
- **Scene MEM Auto Update**  
If this check box is on, you can use the Scene Memory Auto Update function (see page 159).
- **Joystick Auto Grab**  
If this check box is on, the [GRAB] button is automatically enabled and the Joystick is engaged in as the surround pan control when you move the Joystick pointer to the current surround pan position.
- **Cascade COMM Link**  
If this check box is on, various functions and parameters are linked between cascaded DM1000s (See page 265 for more information on cascade connection). When the check box is off, only the Solo function is linked.
- **Auto Direct Out On**  
If this check box is on and you change the channel Direct Out destination from “–” to any other output, the channel Direct Out is automatically enabled. If you change the channel Direct Out destination from an output to “–,” the channel Direct Out is automatically disabled.

## Prefer2 page

The Prefer2 page enables you to name the channel indicated on the display, and adjust the display brightness.

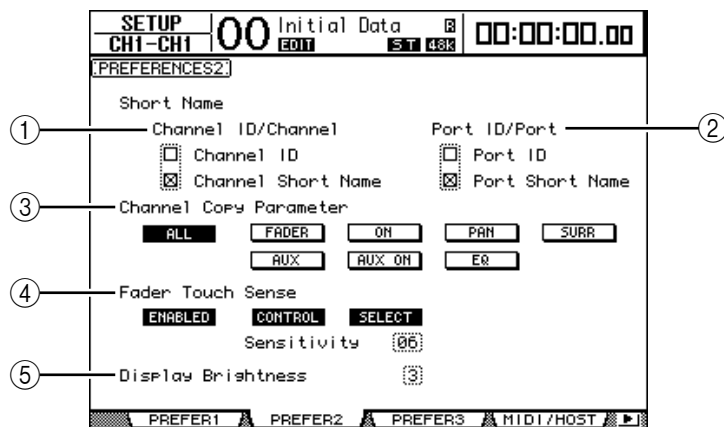

This page contains the following parameters:

- ① **Channel ID/Channel**  
This parameter selects a style for displayed channel. If the Channel ID check box is selected, the Channel ID appears (e.g., CH1, BUS1). If the Channel Short Name check box is on, the Channel Short name appears (see page 249).
- ② **Port ID/PORT**  
This parameter selects a format for the port name displayed on the pages. When the Port ID check box is on, the Port ID (such as AD1 or OMN10) appears. When the Port Short Name check box is on, the Short Port name appears (see page 250).

③ **Channel Copy Parameter**

This parameter selects the channel parameters to be copied when you assign the Channel Copy function to one of the User Defined buttons (see page 257). You can select multiple options.

- **ALL**..... This button selects all parameters that can be copied. When you turn on this button, all other options are cancelled.
- **FADER**..... Copies the fader values.
- **ON**..... Copies the on/off status of the [ON] buttons.
- **PAN**..... Copies the pan settings.
- **SURR**..... Copies the surround pan settings.
- **AUX**..... Copies the Aux Send levels.
- **AUX ON**..... Copies the on/off status of the Channel to Aux signals.
- **EQ**..... Copies the EQ parameter values.

④ **Fader Touch Sense**

These parameters control the Touch Sense function.

- **ENABLED/DISABLED**.. This button enables or disables the Touch Sense function.
- **CONTROL**..... If this button is turned on and the touch sensors are not triggered, fader operations is ignored. During Automix recording, you can perform “cut-in” style operations by touching a fader. When this button is off, the DM1000 always recognizes fader movements.
- **SELECT**..... If this button is on, you can select channels using the Touch Sense function.
- **Sensitivity**..... This parameter adjusts the touch sensitivity in the range of 01 to 10.

⑤ **Display Brightness**

This parameter sets the brightness of the display, Scene Memory display, and the button indicators in the range of 1 through 4.

**Prefer3 page**

This page enables you to set various Automix preferences.

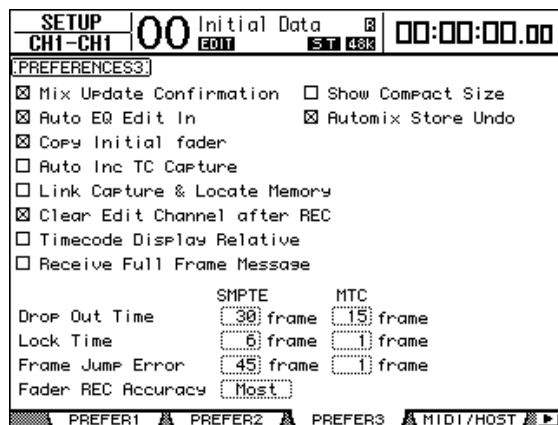

This page contains the following parameters. (These parameters are explained in the order from the top of the left column to the bottom of the right column).

- **Mix Update Confirmation**

If this check box is on, when Automix recording stops, a confirmation message appears asking if you want to update the current Automix with the latest edits.

- **Auto EQ Edit in**  
If this check box is on, EQ settings are automatically punched into the Automix recording when you adjust an EQ control in the SELECTED CHANNEL section.
- **Auto Inc TC Capture**  
If this check box is on, the Timecode Capture memory is incremented automatically each time a timecode address is captured on the Automix | Event Edit page (see page 202).
- **Link Capture & Locate Memory**  
If this check box is on, the Capture memories on the Automix | Event Edit page are linked to the Locate memories.
- **Clear Edit Channel after REC**  
If this check box is on, the previously-recorded channel events are automatically cleared when Automix recording (with Auto Rec on) stops.
- **Timecode Display Relative**  
If this check box is on, the indicated timecode is offset based on the OFFSET parameter on the Main page.
- **Receive Full Frame Message**  
If this check box is on, MTC full-frame messages, in addition to the usual quarter-frame messages, are recognized and Automix follows them. If this check box is off, only the usual quarter-frame messages are recognized.
- **Show Compact Size**  
Automix data is compressed while recording. If this check box is on, the DM1000 displays the compressed size of the Automix.
- **Automix Store Undo**  
If this check box is on, you can undo the Automix Store & Clear functions.
- **Copy Initial Fader**  
If this check box is on, the fader value recorded immediately before the specified IN point is copied to the specified TO point when you copy or move the Fader events. This eliminates fader position matching problems when no fader event exists at the specified TO point.
- **Drop Out Time**  
This parameter sets an interval (in frames) between the interruption of incoming timecode and the stoppage of Automix recording or playback.
- **Lock Time**  
This parameter sets the interval (in frames) allowed until the Automix locks to incoming timecode messages. If the sync operation is unstable, set this value higher.
- **Frame Jump Error**  
This parameter sets the time interval (in frames) required by the DM1000 to recognize an error after incoming timecode messages jump. If the actual interval is shorter than the value specified by this parameter, the DM1000 continues the sync operation. If the frame jump causes the recording or playback to stop during the MTC sync operation, set the parameter value higher than the number of frames indicated in the error message.  
If you set the parameter to a higher value, adjust the Drop Out Time parameter value, if necessary.
- **Fader REC Accuracy**  
This parameter sets the accuracy of recording faders over time to “Little,” “Some,” “More,” or “Most.” If you set the parameter to lower values, you will save Automix memory space.

## Creating a Custom Layer by Combining Channels (User Assignable Layer)

If you set the Remote Layer target to “USER ASSIGNABLE,” you can create a custom layer by combining any DM1000 channels (excluding the Stereo Out). This custom layer is called “User Assignable layer.” You can use either Remote 1 or Remote 2 for a User Assignable layer.

- 1 Press the **DISPLAY ACCESS [REMOTE]** button, then press the **[F1]** or **[F2]** button.

The Remote | Remote1 or Remote2 page appears.

- 2 Set the **TARGET** parameter to **USER ASSIGNABLE**, then press **[ENTER]**.

A confirmation window appears.

- 3 Move the cursor to the **YES** button, then press **[ENTER]**.

The DM1000 displays the page shown below.

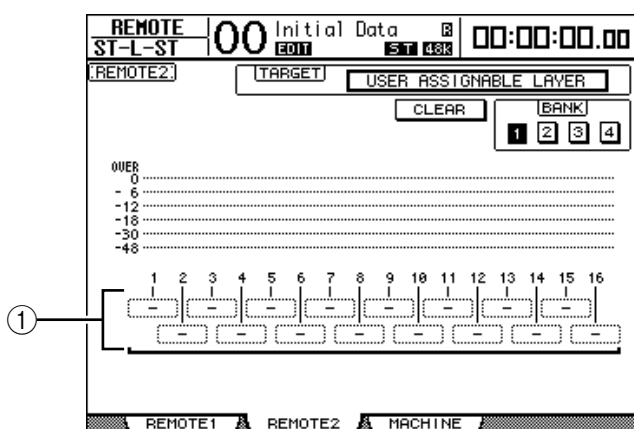

- 4 Select the channels you wish to assign to the User Assignable layer using the 1–16 parameter boxes (①).

You can store up to four 16-channel setups in four banks by switching Banks 1–4 via the BANK 1–4 buttons.

**Tip:** You can reset the assignment to default by moving the cursor to the **CLEAR** button and pressing **[ENTER]**.

- 5 Use the **LAYER [REMOTE 1]** or **[REMOTE 2]** button to assign or recall the User Assignable layer.

You can use the faders, Encoders, and **[ON]** buttons to control the assigned channels.

**Tip:** If you connected an optional MB1000 Meter Bridge, its meters indicate the level of the channels currently-assigned to layer channels 1–16.

## Using the Oscillator

The DM1000 features an Oscillator you can use for sound checks. Follow the steps below to use the Oscillator:

- 1 Press the **DISPLAY ACCESS [UTILITY]** button, then press the **[F1]** button.

The Utility | Oscillator page appears.

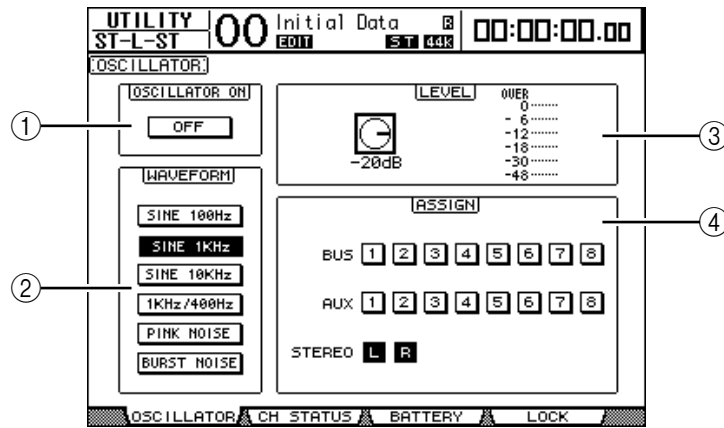

This page contains the following parameters:

- ① **OSCILLATOR ON**  
This parameter button turns the Oscillator on or off.
- ② **WAVEFORM**  
These parameter buttons select the Oscillator waveforms.
- ③ **LEVEL section**  
The parameter control in this section sets the Oscillator output level.
- ④ **ASSIGN section**  
The buttons in this section select the Oscillator output.

- 2 Move the cursor to the button for the Oscillator output channel in the **ASSIGN** section, then press **[ENTER]** (you can select multiple channels).
- 3 Move the cursor to one of the **WAVEFORM** parameter buttons, then press **[ENTER]**.

You can select the following waveforms:

- **SINE 100Hz** ..... 100 Hz sinewave
- **SINE 1kHz** ..... 1 kHz sinewave
- **SINE 10kHz** ..... 10 kHz sinewave
- **1kHz/400Hz** ..... Sinewave with different frequency output to L, R, and odd/even buses
- **PINK NOISE** ..... Pink noise
- **BURST NOISE** ..... Burst noise (200 msec pink noise pulses at four second intervals)

- 4 Move the cursor to the parameter control in the **LEVEL** section, then rotate the Parameter wheel to set the Oscillator level to minimum.

***Note:** Sinewave and pink noise create unusually high sound pressure. Oscillator levels that are too high can damage the speakers. When you use the Oscillator, be sure to set the level to minimum, then raise the level gradually.*



- 5 Move the cursor to the **OSCILLATOR ON/OFF** button, then press the **[ENTER]** or **[INC]/[DEC]** buttons to turn on the Oscillator.

The Oscillator signal is now routed to the channels selected in the ASSIGN section.

- 6 Move the cursor to the parameter control in the **LEVEL** section, then rotate the **Parameter wheel** to raise the Oscillator level.

You can view the current Oscillator level on the **LEVEL** meter.

## Using the User Defined Keys

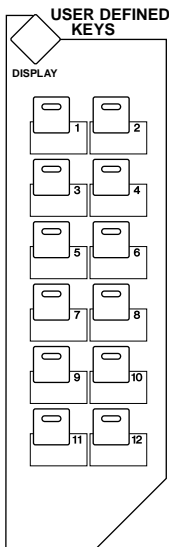

You can assign any of more than 200 functions to the **USER DEFINED KEYS** [1]–[12].

If you assign to one of the buttons (or “keys”) a function that is usually executed on the display pages, you can use the assigned button as a shortcut.

The Function to User Defined Keys assignments are stored in banks. (See page 287 for more information on the initial bank settings.) The DM1000 provides eight banks (Banks A–H). Switching banks enables you to change the assignment quickly.

Follow the steps below to assign functions to the **USER DEFINED KEYS**.

- 1 Press the **USER DEFINED KEYS [DISPLAY]** button to locate the **User Def | User Def** page.

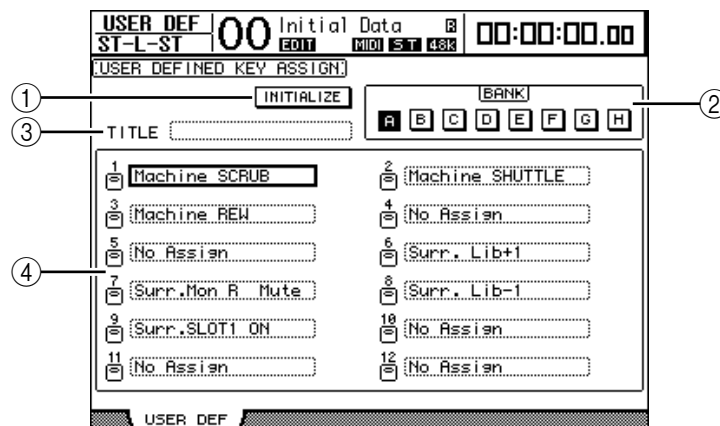

This page contains the following parameters:

- ① **INITIALIZE**  
This button resets the contents of all banks to their initial settings.
- ② **BANK**  
These buttons select the desired banks.
- ③ **TITILE**  
This parameter displays the name of the bank selected by the **BANK** parameter button. Move the cursor to the **TITILE** parameter box, then press **[ENTER]**. The Title Edit window appears, enabling you to enter a name.
- ④ **1–12**  
These parameter boxes enable you to assign functions to **USER DEFINED KEYS** [1]–[12].

**2 Move the cursor to the desired BANK parameter button, then press [ENTER].**

The corresponding bank is selected, and the functions assigned to the User Defined buttons in that bank are displayed in the 1–12 parameter boxes.

**Tip:** When you select a function that is executed based on specified numbers (for example, a function that recalls a specific Scene or library memory or transmits MIDI messages), an extra parameter box appears on the right, in which you must specify the number.

**3 Move the cursor to one of the 1–12 parameter boxes, then press [ENTER].**

The DM1000 displays the User Define Select window, which enables you to assign functions to the selected buttons.

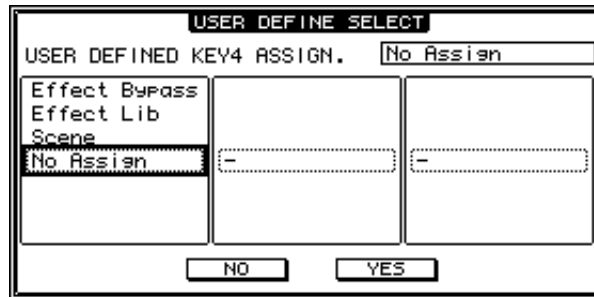
**4 Move the cursor to the left column, then rotate the Parameter wheel or press the [INC]/[DEC] buttons to select a function you wish to assign.**

A function is selected when it appears inside the dotted box. See page 275 for a complete list of assignable functions.

**5 In the same way, set the center and right column.**

The items that appear in the center and right columns vary depending on the function selected in Step 4.

**6 To close the window, move the cursor to the YES button, then press [ENTER].**

When the window closes, the specified function is assigned to the selected User Defined button.

To cancel the assignment, move the cursor to the CANCEL button, then press [ENTER].

**7 If you assigned functions that require numbers (such as recalling a Scene or library memory), move the cursor to the extra parameter box shown on the right and specify the number.****Tip:**

- You can store User Defined Keys banks to a computer hard disk using the included Studio Manager software. Be sure to back up important data.
- You can also store the assignment data to an external device, such as a MIDI data filer, by using MIDI Bulk Dump (see page 246).

## Using GPI (General Purpose Interface)

The DM1000's CONTROL port provides a GPI (General Purpose Interface) for controlling external equipment. You can configure the GPI so that it will output 8-channel trigger signals when you operate the faders or USER DEFINED KEYS, or so that it will receive 4-channel trigger signals to control the DM1000 parameters.

You can assign functions to these trigger signals. In this way, for example, you can control a "RECORDING" warning light outside a studio from the DM1000, or you can control the DM1000's Talkback function or Dimmer function using an outside switch.

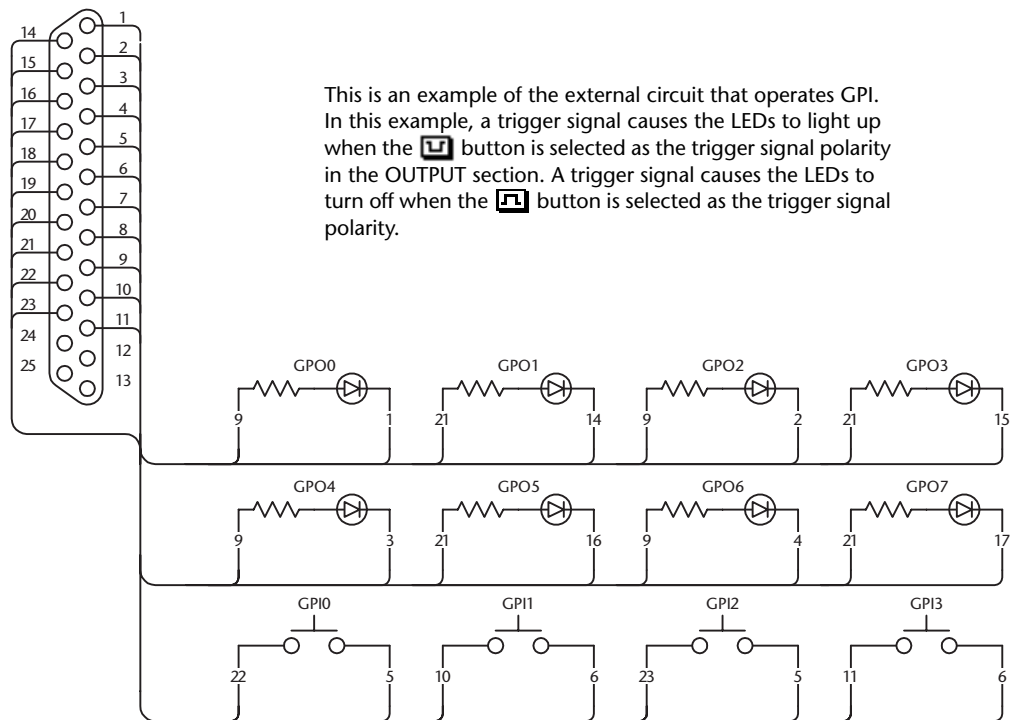

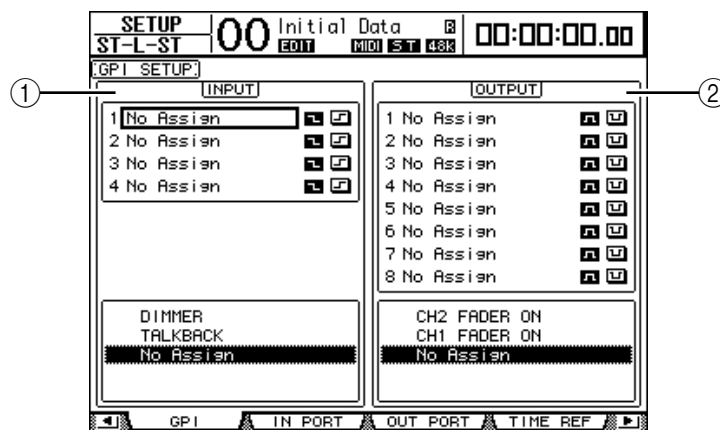

- 1 Press the DISPLAY ACCESS [SETUP] button repeatedly until the Setup | GPI page appears.



- ① **INPUT section**

This section enables you to select functions that will be controlled via trigger signals 1–4 input at the CONTROL port. Assignable functions are listed in the area below this section.
- ② **OUTPUT section**

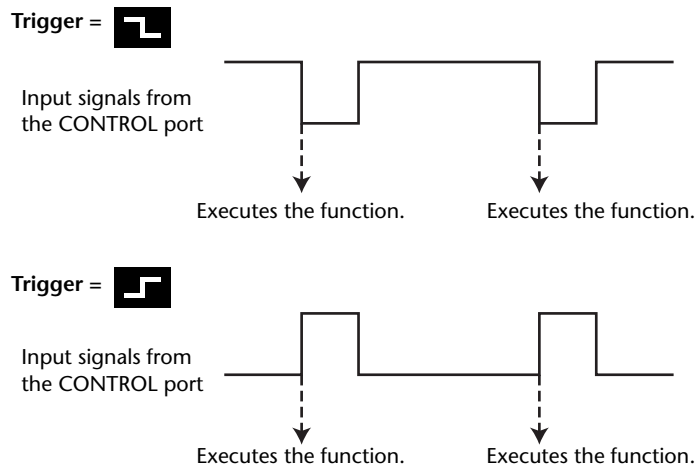

This section enables you to select the sources that will output trigger signals 1–8. Selectable sources are listed in the area below this section.

- 2 To assign functions to the incoming trigger signals, move the cursor to one of four trigger signal parameters 1–4 in the INPUT section.
- 3 Rotate the Parameter wheel to select the desired function from the list below the INPUT section, then press [ENTER] to confirm the selection.
- 4 Select one of two buttons located to the right of trigger signal parameters 1–4 to specify how the incoming trigger signals will be detected.
  -  .....When the switch is grounded (Low), the trigger signal is active and the selected parameter changes.
  -  .....When the GPI Input goes High (open), the trigger signal is active and the selected parameter changes.



At this point, when the DM1000 receives the trigger signal at the CONTROL port, the selected parameter changes.

**Tip:** Refer to the next page for a complete list of assignable parameters.

- 5 To select parameters or controls as the trigger signal sources, move the cursor to the OUTPUT section and select the desired trigger signal parameters 1–8 in the same way as for the INPUT section.
- 6 Use the buttons located to the right of the trigger signal (1–8) parameters to switch the polarity of the trigger signals that are output when you control the trigger sources.
  -  .....The GPI Output goes High (open) when the trigger signal source is active.
  -  .....The GPI Output goes Low (ground) when the trigger signal source is active.

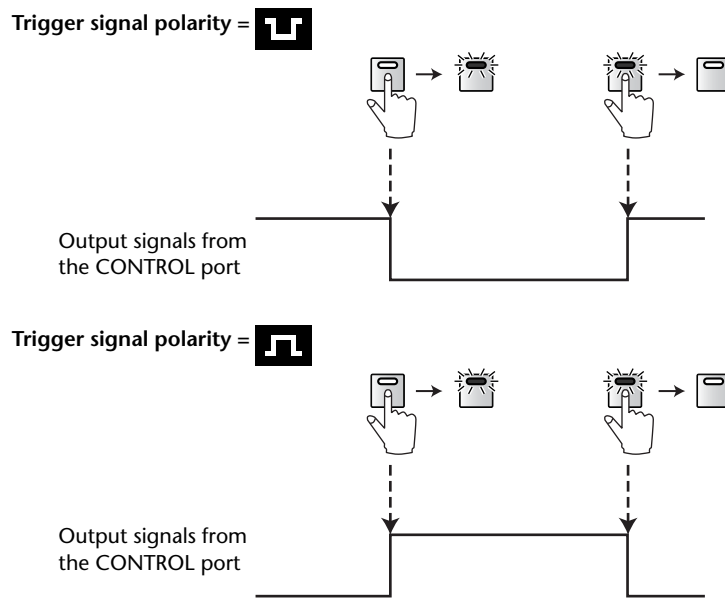

At this time, the trigger signal is output from the CONTROL port when you operate the assigned parameters or controls.

**Tip:** Refer to the next page for a complete list of assignable parameters and controls.

■ Parameters available in the INPUT section

No Assign	AUX1 ON
TALKBACK	:
DIMMER	AUX8 ON
BUS	ST ON
SLOT	CH1 ON UNLATCH
STEREO	:
2TRD1	CH48 ON UNLATCH
2TRD2	BUS1 ON UNLATCH
TALKBACK UNLATCH	:
DIMMER UNLATCH	BUS8 ON UNLATCH
BUS UNLATCH	AUX1 ON UNLATCH
SLOT UNLATCH	:
STEREO UNLATCH	AUX8 ON UNLATCH
2TRD1 UNLATCH	ST ON UNLATCH
2TRD2 UNLATCH	UDEF1
CH1 ON	:
:	UDEF12
CH48 ON	
BUS1 ON	
:	
BUS8 ON	

- **TALKBACK/DIMMER**..... Same as the MONITOR [TALKBACK] and [DIMMER] button functions.
- **BUS/SLOT**..... Same as the MONITOR [BUS] and [SLOT] button functions.
- **STEREO/2TRD1/2TRD2**..... Same as the MONITOR [STEREO], [2TRD1], and [2TRD2] button functions.

- **xxx UNLATCH**..... The assigned button function is enabled only while the incoming trigger signal is active.
- **xxx ON** ..... The corresponding channels are turned on or off each time the incoming trigger signal becomes active.
- **xxx ON UNLATCH**..... The corresponding channels are turned on only while the incoming trigger signal is active.
- **UDEFxxx** ..... Same as the corresponding User Defined buttons.

■ **Trigger sources available in the OUTPUT section**

No Assign	ST FADER OFF
CH1 FADER ON	CH1 FADER TALLY
:	:
CH48 FADER ON	CH48 FADER TALLY
BUS1 FADER ON	BUS1 FADER TALLY
:	:
BUS8 FADER ON	BUS8 FADER TALLY
AUX1 FADER ON	AUX1 FADER TALLY
:	:
AUX8 FADER ON	AUX8 FADER TALLY
ST FADER ON	ST FADER TALLY
CH1 FADER OFF	UDEF1 LATCH
:	:
CH48 FADER OFF	UDEF12 LATCH
BUS1 FADER OFF	UDEF1 UNLATCH
:	:
BUS8 FADER OFF	UDEF12 UNLATCH
AUX1 FADER OFF	REC LAMP
:	
AUX8 FADER OFF	POWER ON

- **xxx FADER ON** ..... The trigger signal is transmitted when you raise a fader from  $-\infty$ .
- **xxx FADER OFF**..... The trigger signal is transmitted when you lower a fader to  $-\infty$ .
- **xxx FADER TALLY** ..... The trigger signal is transmitted while a fader remains above  $-\infty$ .
- **xxx LATCH** ..... Pressing the corresponding button toggles the trigger signal on and off.
- **xxx UNLATCH** ..... The trigger signal is transmitted while you are pressing and holding down the corresponding button.
- **REC LAMP** ..... The trigger signal is transmitted while the transport section on the Remote | Machine Control page is in record mode.
- **POWER ON** ..... The trigger signal is transmitted while the power to the DM1000 is on.

## Using Operation Lock

The DM1000 features an Operation Lock function that prevents unintentional edits and restricts access to panel operation with a password.

To use the Operation Lock function, press the [UTILITY] button, then the [F4] button to display the Utility | Lock page.

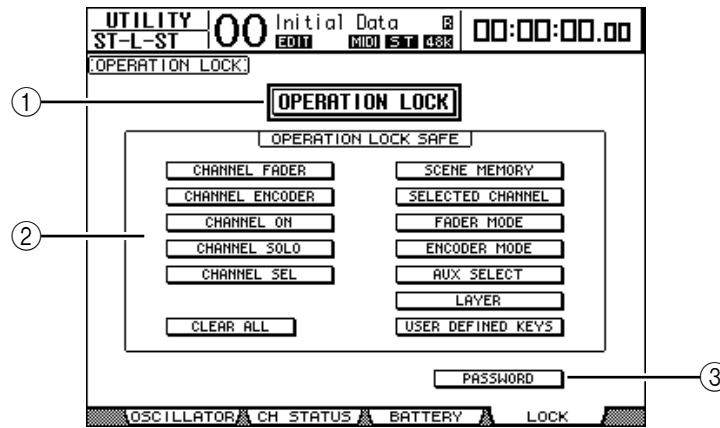

This page contains the following parameters:

### ① OPERATION LOCK

This button enables or cancels Operation Lock. When you turn on this button, the Password window appears.



Enter a four-letter password using the Channel 1–10 [SEL] buttons (Channel 10 [SEL] button enters “0”). (The password characters are represented by asterisks.) Move the cursor to the OK button, then press [ENTER] to enable Operation Lock.

To cancel Operation Lock, turn off the OPERATION LOCK button. The Password window appears again. Enter the password and select the OK button. Operation Lock is cancelled.

**Note:** If you forget the password, you cannot cancel Operation Lock. Be sure to write down the password.

### ② OPERATION LOCK SAFE section

This section enables you to select certain controls on the panel to exclude from Operation Lock. To cancel all “safe” buttons simultaneously, move the cursor to the CLEAR ALL button, then press [ENTER].

**③ PASSWORD**

This button enables you to change the current password. Move the cursor to the PASSWORD button, then press [ENTER]. The Set Password window appears, enabling you to change the password.



SET PASSWORD

USE [SEL1] - [SEL10]

PASSWORD

NEW PASSWORD

REENTRY

CANCEL OK CLEAR

Enter the current password in the PASSWORD field, and a new password in the NEW PASSWORD field. Enter the new password again in the REENTRY field located below the NEW PASSWORD field. Move the cursor to the OK button, then press [ENTER] to change the password.

**Tip:** To clear the registered password, move the cursor to the CLEAR button, then press [ENTER]. If you forget the password, initialize the password setting (see page 273).



## Cascading Consoles

The DM1000 features a Cascade Bus that enables cascade connection. You can connect two DM1000s in cascade using the digital inputs and outputs, or the OMNI IN and OMNI OUT connectors. In this way, two consoles work just like one big console, integrating each unit's Buses 1–8, Aux Sends 1–8, Stereo Bus, and Solo Bus.

The following DM1000 functions are linked via the cascade connection. To link functions and parameters (excluding the Solo function), turn on the Cascade COMM Link check box on the Setup | Prefer1 page (see page 250).

- Display page selection
- Aux selection
- Solo function
- Fader Mode
- Encoder Mode
- Metering Position
- Peak Hold On/Off
- Meter Fast Fall on/off
- Scene Store, Recall, and Title Edit
- The following Automix functions:
  - Make New Automix
  - Store and Recall Automix
  - Automix Title Edit of
  - Automix Transport (AutoREC, REC, PLAY, STOP,ABORT)
- The following Automix parameters:
  - Automix Enable/Disable
  - Motor On/Off
  - Frame Type
  - Return Time
  - Int Start Time
  - TC Offset
  - Write to End
  - Fader Return
  - Fader Edit Mode
  - Touch Sense In
  - Touch Sense Out
  - Overwrite (FADER/CH ON/PAN/EQ/AUX/AUX ON/SURR)

**Tip:** The Solo function is always linked regardless of the status of the Cascade COMM Link check box.

The following paragraphs explain how to make a cascade connection using two DM1000s and the inputs and outputs of digital I/O cards installed in the slots of two DM1000s.

**1 Install digital I/O cards into Slot 1 or 2 on two DM1000s.**

**2 Connect two DM1000s as follows:**

- If you want to use the REMOTE connector to transfer MIDI messages, connect the REMOTE connector of each DM1000 using a 9-pin D-sub reverse cable. If you want to use the MIDI IN and OUT ports, connect MIDI IN on one DM1000 to MIDI out on the other DM1000 using a MIDI cable.

The following connection example uses the REMOTE connectors.

- Connect the digital I/O card output on the transmitting DM1000 (slave) to the digital I/O card input on the receiving DM1000 (master).

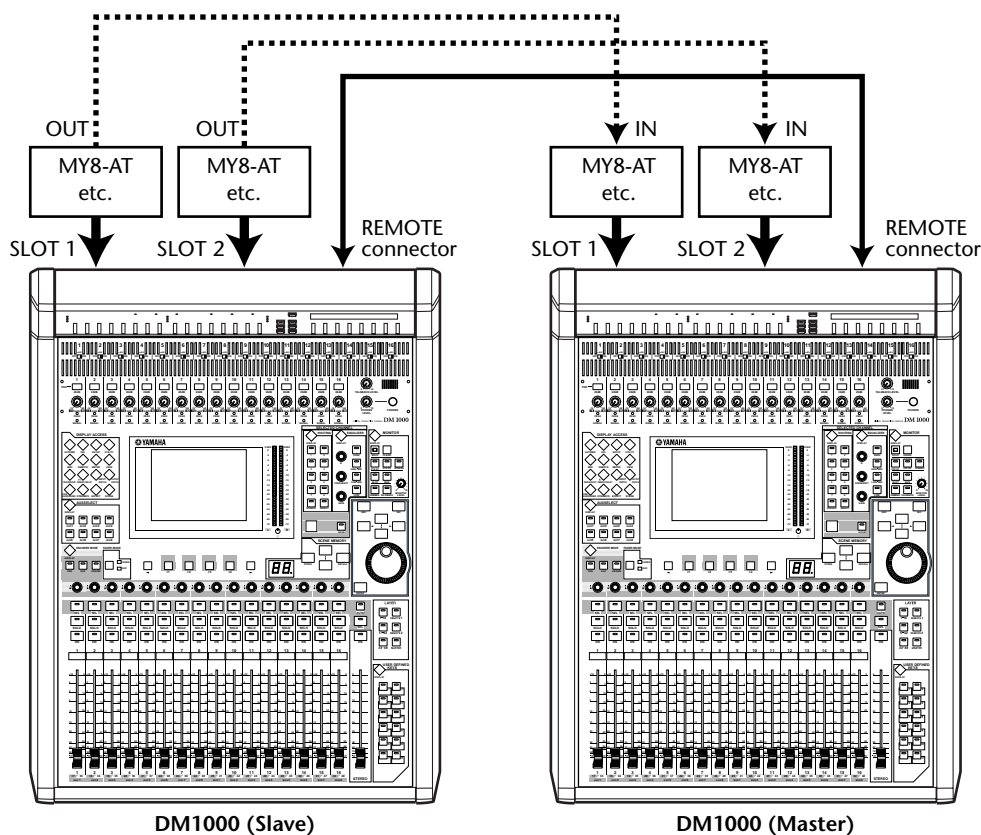

**Tip:** To link Automixes between two DM1000s in a cascade system, configure the units so that they can receive the same sync signal (SMPTE or MTC). If necessary, connect a distribution box to distribute the sync signal to each DM1000.

**Note:** Do not make any MIDI connections between DM1000s that are cascaded via the REMOTE connectors, or vice versa. Otherwise, a loop will be created, causing both consoles to execute endless transmission and reception.

**3 On the slave unit, press the DISPLAY ACCESS [OUTPUT PATCH] button repeatedly until the Out Patch | Slot Out page appears.**

**4 Assign the Bus signals to the slot channels that are used for the cascade connection.**

The following signals are available:

Options	Description
CAS BUS1–BUS8	Bus 1–8 Cascade Outs
CAS AUX1–AUX8	Aux Bus 1–8 Cascade Outs
CAS ST-L, CAS ST-R	Stereo Bus L & R Cascade Outs
CASSOLOL, CASSOLOR	Solo Bus L & R Cascade Outs

The following display page is an example of integrating Bus 1–8, Aux Send 1–4, Stereo Bus, and Solo Bus signals via two 8-channel digital I/O cards (such as MY8-AT).

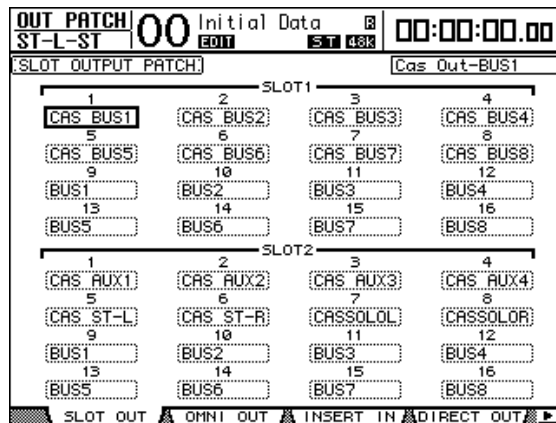

**Tip:** Patching may vary depending on the type and number of buses used for the cascade connection.

**Note:** Since the number of channels available on the digital I/O cards is limited, only Aux Sends 1–4 are cascaded in this example. Using a 16-channel digital I/O card (such as MY16-AT) enables you to cascade all buses.

- 5 On the master unit, press the DISPLAY ACCESS [INPUT PATCH] button repeatedly until the In Patch | Cascade In page appears.
- 6 Select the Input Channels on the master unit to which the Bus signals are input from the Slave unit.

The following display page is an example of receiving the slave unit’s Bus 1–8, Aux Send 1–4, Stereo Bus, and Solo Bus signals via two 8-channel digital I/O cards (such as MY8-AT).

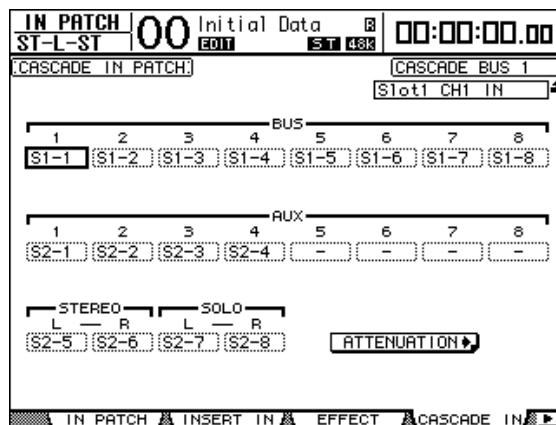

**Note:** Be sure to patch the slave Bus signals to the same Buses on the master unit. Incorrect patching will result in an incorrect cascade connection.

- 7 On the master unit, press the DISPLAY ACCESS [DIO] button repeatedly until the DIO | Cascade page appears, then adjust the Attenuators using the parameter controls.

The DIO | Cascade page enables you to adjust the level of signals input to the Cascade Bus using the dedicated attenuators. You can also turn the Cascade Buses on or off using the buttons below the parameter controls.

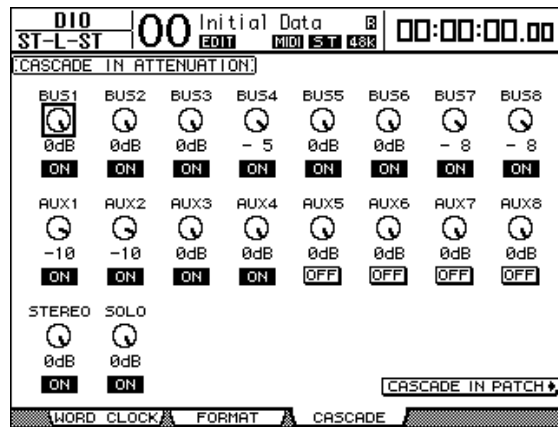

- 8 On the slave unit, press the DISPLAY ACCESS [SETUP] button repeatedly to display the Setup | Remote page, then set the REMOTE FUNCTION parameter (1) to "MIDI."

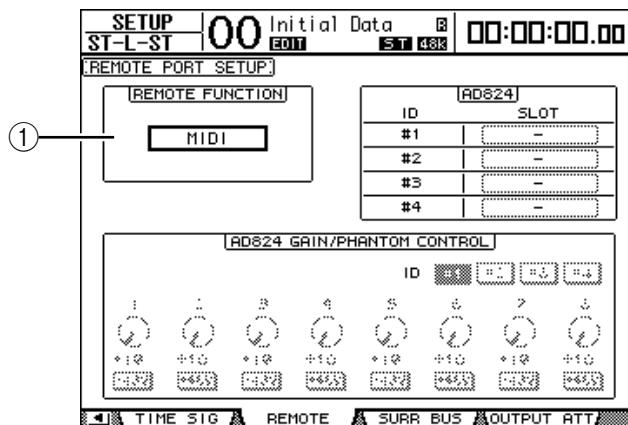

- 9 Press the DISPLAY ACCESS [SETUP] button repeatedly to display the Setup | MIDI/Host page, then set the Cascade Link parameter to "REMOTE."

After Steps 8 and 9, the slave unit will be able to transmit and receive MIDI messages via the REMOTE connector.

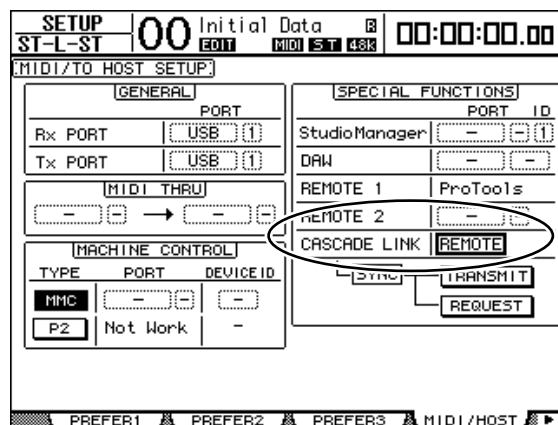

- 10 Repeat Steps 8 and 9 for the master unit so that it will be able to transmit and receive MIDI messages via the REMOTE connector.
- 11 To match the parameters of both DM1000s, locate the Setup | MIDI/Host page on the copy source unit.
- 12 Move the cursor to the TRANSMIT button for the SYNC parameter, then press [ENTER].

Data, such as libraries and Scene memories, on the copy source unit is copied onto the other DM1000 via the REMOTE connector. If you select the REQUEST button instead of the TRANSMIT button for the SYNC parameter, you can reverse the copy direction.

At this point, Bus 1–8, Aux 1–4, and the Stereo Bus on both DM1000s are integrated, and the data is output via Bus Outs 1–8, Aux Outs 1–4, and the Stereo Out on the master unit. If you solo channels on one of the DM1000s, you can monitor the soloed signals via the Control Monitor.

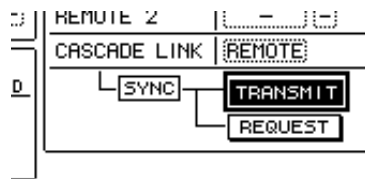

**Note:** You can also link the parameters using the MIDI IN and OUT connection if you set the CASCADE LINK parameter to "MIDI."

## Using the AD824

The Yamaha AD824, an 8-channel AD converter, enables you to control its gain and phantom power from a connected DM1000. The DM1000 can control up to four AD824s simultaneously.

If you connect the DM1000 to the AD824 digitally, and connect the DM1000 REMOTE connector to the AD824 COM PC/RS422 connector using a serial cable, you can use the AD824 as AD Inputs for which you can preset the gain.

**Tip:** You cannot store the Phantom power setting as a Scene on the DM1000.

This section describes how to connect and configure the DM1000 and two AD824s.

### 1 Install digital I/O cards into slots on the DM1000 and AD824.

### 2 Connect the DM1000 and AD824s as follows.

- Connect the DM1000 REMOTE connector to the COM RS422 connector of the first AD824 using a 9-pin D-sub reverse cable.
- Connect the COM PC/RS422 connector of the first AD824 to the COM PC/RS422 connector of the second AD824 using a 9-pin D-sub reverse cable.
- Connect the outputs of the digital I/O cards on each AD824 to the inputs of the DM1000 I/O card.

Connection methods and cables vary depending on the specifications of the devices. The following illustration is an example of a system in which two AD824s are connected via MY8-AE cards.

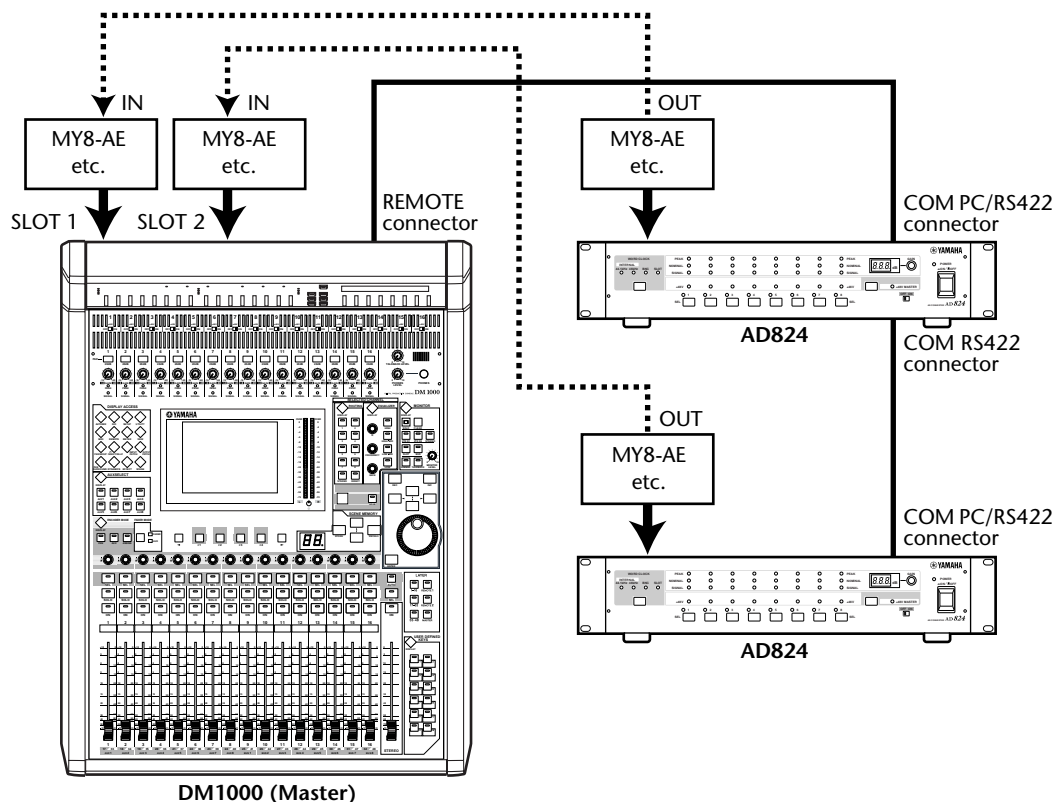

**Note:** Set the AD824 COM PC/RS422 switches to “RS422.” (If these switches are set to “PC,” the system will not work correctly.)

**Tip:**

- For information on digital I/O cards that are compatible with the AD824, refer to the AD824 Owner’s Manual or visit the Yamaha Pro Audio web site (<http://www.yamahaproaudio.com/>)
- Multiple AD824s in a system must have unique IDs.

- 3 Press the DISPLAY ACCESS [SETUP] button repeatedly until the Setup | Remote page appears.

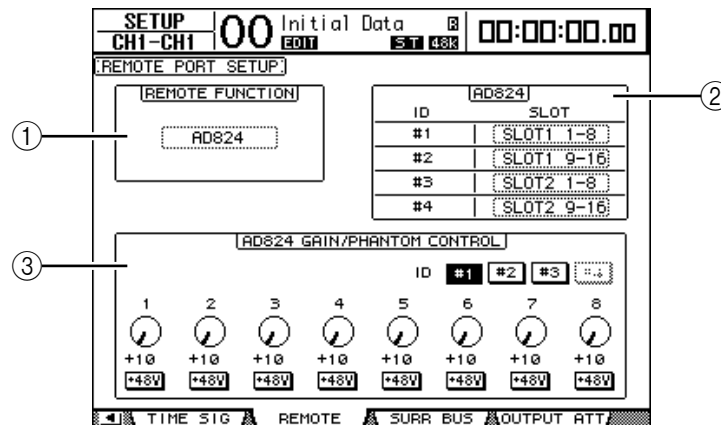

This page contains the following parameters:

① **REMOTE FUNCTION**

This parameter selects a device to be connected to the DM1000 REMOTE connector.

② **AD824 section**

This section enables you to specify the slot channels that will receive eight channel signals from AD824s that have their ID numbers set to 1 through 4.

③ **AD824 GAIN/PHANTOM CONTROL section**

This section enables you to set the AD824 channel 1–8 gain and the Phantom power on or off.

- ID #1–#4.....These buttons select the AD824s you want to control.
- 1–8.....These parameter controls adjust the gain for AD824 channels 1–8.
- +48V .....When you turn on these buttons, the phantom power on the corresponding channels are turned on.

- 4 Make sure that the REMOTE FUNCTION parameter is set to “AD824,” and in the AD824 section select the slot channels that receive signals from the AD824s.
- 5 Use the parameter controls and buttons in the AD824 GAIN/PHANTOM CONTROL section to set the channel gain and switch the channel phantom power on or off.

## Checking the Battery and the System Version

The Utility | Battery page enables you to check the condition of the internal memory-backup battery and the system version number. To locate this page, press the DISPLAY ACCESS [UTILITY] button repeatedly.

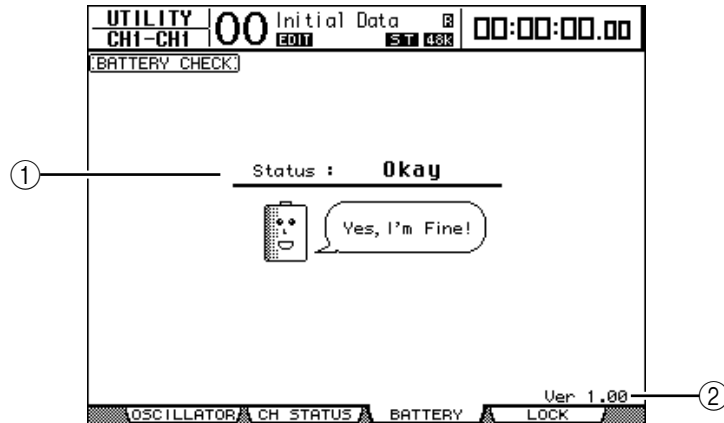

### ① Status

If the Status is “Okay,” the battery has sufficient voltage for operation. If the Status is “Voltage low!,” ask your Yamaha dealer to replace the battery as soon as possible. Failure to replace a low battery may result in data loss.

**Note:** Do not attempt to replace the battery yourself as a malfunction may occur.

### ② Ver X.XX (X.XX represents the version number.)

This indicator identifies the system version number. Check the current system version number before you update the system software.



## Initializing the DM1000

You can delete all currently-recorded settings and restore the factory-preset values, and reset the Operation Lock password to its initial setting. Follow the steps below.

**Tip:**

- If you want to keep the current internal data, be sure to first back up the data using the included Studio Manager software.
- You can also store the data to an external MIDI device, such as a MIDI data filer, by using MIDI Bulk Dump (see page 246).

- 1 Make sure that the power to the DM1000 is turned off.**
- 2 While holding down the SCENE MEMORY [STORE] button, turn on the POWER ON/OFF switch.**

After a moment, the DM1000 displays the following confirmation window.



- 3 To reset the DM1000 to factory default settings, move the cursor to the INITIALIZE button, then press [ENTER].**

To cancel the initialization operation, move the cursor to the CANCEL button, then press [ENTER].

When the internal data is thoroughly overwritten, the DM1000 restarts using the factory settings.

- 4 To reset the Operation Lock password to its initial setting, in Step 2, move the cursor to the PASSWORD button, then press [ENTER].**

The password is reset to “1234”.

If you do not take any action after the confirmation window appears, the window automatically closes and the DM1000 restarts without being initialized.

## Calibrating the Faders

The DM1000 motorized fader positions may shift over time depending on the operating conditions and environment. You can correct the shifted faders using the Calibration function.

- 1 Make sure that the power to the DM1000 is turned off.**
- 2 While holding down the [ENTER] button, turn on the POWER ON/OFF switch.**

After a moment, the DM1000 displays a message indicating that the calibration is in progress. Calibration takes about two minutes. It is important that you do not touch the faders while this message is displayed.

When calibration is finished, the DM1000 displays a page that enables you to fine-tune the fader position.

- 3 Follow the instructions on the display and lower all faders to  $-\infty$ , then press [ENTER].**
- 4 Set faders 1–16 to  $-15$  and the Stereo fader to  $-30$ , then press [ENTER].**
- 5 Set faders 1–16 to 0, then press [ENTER].**

Proceed to the next step without moving the Stereo fader this time.

- 6 Finally, set faders 1–16 to  $+10$  and the Stereo fader to 0, then press [ENTER].**

This is the end of the fader calibration process. The DM1000 restarts in normal mode.

# Appendix A: Parameter Lists

## USER DEFINED KEYS

#	Function	Display
0	No Assign	No Assign
1	Scene MEM. Recall +1	Scene +1 Recall
2	Scene MEM. Recall -1	Scene -1 Recall
3	Scene MEM. Recall No. XX	Scene XX Recall
4	Effect-1 Lib. Recall +1	Fx1 Lib+1 Recall
5	Effect-1 Lib. Recall -1	Fx1 Lib-1 Recall
6	Effect-1 Lib. Recall No.XX	Fx1 LibXXX RCL.
7	Effect-2 Lib. Recall +1	Fx2 Lib+1 Recall
8	Effect-2 Lib. Recall -1	Fx2 Lib-1 Recall
9	Effect-2 Lib. Recall No.XX	Fx2 LibXXX RCL.
10	Effect-3 Lib. Recall +1	Fx3 Lib+1 Recall
11	Effect-3 Lib. Recall -1	Fx3 Lib-1 Recall
12	Effect-3 Lib. Recall No.XX	Fx3 LibXXX RCL.
13	Effect-4 Lib. Recall +1	Fx4 Lib+1 Recall
14	Effect-4 Lib. Recall -1	Fx4 Lib-1 Recall
15	Effect-4 Lib. Recall No.XX	Fx4 LibXXX RCL.
16	Effect-1 Bypass On/Off	Fx1 Bypass
17	Effect-2 Bypass On/Off	Fx2 Bypass
18	Effect-3 Bypass On/Off	Fx3 Bypass
19	Effect-4 Bypass On/Off	Fx4 Bypass
20	Channel Lib. Recall +1	CH Lib+1 Recall
21	Channel Lib. Recall -1	CH Lib-1 Recall
22	Channel Lib. Recall No. XX	CH LibXXX Recall
23	GATE Lib. Recall +1	Gate Lib+1 RCL.
24	GATE Lib. Recall -1	Gate Lib-1 RCL.
25	GATE Lib. Recall No. XX	Gate LibXXX RCL.
26	COMP Lib. Recall +1	Comp Lib+1 RCL.
27	COMP Lib. Recall -1	Comp Lib-1 RCL.
28	COMP Lib. Recall No. XX	Comp LibXXX RCL.
29	EQ Lib. Recall +1	EQ Lib+1 Recall
30	EQ Lib. Recall -1	EQ Lib-1 Recall
31	EQ Lib. Recall No. XX	EQ LibXXX Recall
32	Surr Lib. Recall +1	Surr. Lib+1
33	Surr Lib. Recall -1	Surr. Lib-1
34	Surr Lib. Recall No.XX	Surr. Libxxx
35	SURR. MONI MUTE Mute L On/Off	Surr.Mon L Mute
36	SURR. MONI MUTE Mute R On/Off	Surr.Mon R Mute
37	SURR. MONI MUTE Mute Ls On/Off	Surr.Mon Ls Mute
38	SURR. MONI MUTE Mute Rs On/Off	Surr.Mon Rs Mute
39	SURR. MONI MUTE Mute C On/Off	Surr.Mon C Mute
40	SURR. MONI MUTE Mute Bs On/Off	Surr.Mon Bs Mute
41	SURR. MONI MUTE Mute LFE On/Off	Surr.Mon LFEMute
42	SURR. MONI SLOT1 ON/OFF	Surr.SLOT1 ON
43	SURR. MONI SLOT2 ON/OFF	Surr.SLOT2 ON

#	Function	Display
44	SURR. MONI BASS MANAGE ON/OFF	Bass Manage ON
45	SURR. MONI SNAP TO 85dB SPL	SNAP TO SPL85
46	Bus to ST Lib. Recall +1	BUS to ST Lib+1
47	Bus to ST Lib. Recall -1	BUS to ST Lib-1
48	Bus to ST Lib. Recall No. XX	BUS to ST LibXX
49	Input Patch Lib. Recall +1	IN Patch Lib+1
50	Input Patch Lib. Recall -1	IN Patch Lib-1
51	Input Patch Lib. Recall No. XX	IN Patch LibXX
52	Output Patch Lib. Recall +1	Out Patch Lib+1
53	Output Patch Lib. Recall -1	Out Patch Lib-1
54	Output Patch Lib. Recall No. XX	Out Patch LibXX
55	Input Fader Group Enable A	IN Fader Group A
56	Input Fader Group Enable B	IN Fader Group B
57	Input Fader Group Enable C	IN Fader Group C
58	Input Fader Group Enable D	IN Fader Group D
59	Input Fader Group Enable E	IN Fader Group E
60	Input Fader Group Enable F	IN Fader Group F
61	Input Fader Group Enable G	IN Fader Group G
62	Input Fader Group Enable H	IN Fader Group H
63	Input MUTE Group Enable I	IN Mute Group I
64	Input MUTE Group Enable J	IN Mute Group J
65	Input MUTE Group Enable K	IN Mute Group K
66	Input MUTE Group Enable L	IN Mute Group L
67	Input MUTE Group Enable M	IN Mute Group M
68	Input MUTE Group Enable N	IN Mute Group N
69	Input MUTE Group Enable O	IN Mute Group O
70	Input MUTE Group Enable P	IN Mute Group P
71	Output Fader Group Enable Q	OutFader Group Q
72	Output Fader Group Enable R	OutFader Group R
73	Output Fader Group Enable S	OutFader Group S
74	Output Fader Group Enable T	OutFader Group T
75	Output MUTE Group Enable U	Out Mute Group U
76	Output MUTE Group Enable V	Out Mute Group V
77	Output MUTE Group Enable W	Out Mute Group W
78	Output MUTE Group Enable X	Out Mute Group X
79	Automix REC	Automix REC
80	Automix PLAY	Automix PLAY
81	Automix STOP	Automix STOP
82	Automix ABORT	Automix ABORT
83	Automix AUTO REC	Automix AUTOREC
84	Automix ENABLE	Automix ENABLE
85	Automix RETURN	Automix RETURN
86	Automix RELATIVE	Automix RELATIVE
87	Automix TOUCH SENSE	Automix T.SENSE
88	Automix UPDATE TO END	Amx UPDATETO END
89	Overwrite FADER	Overwrite FADER
90	Overwrite ON	Overwrite ON
91	Overwrite PAN	Overwrite PAN
92	Overwrite SURROUND	Overwrite SURR.
93	Overwrite EQ	Overwrite EQ

#	Function	Display
94	Overwrite AUX	Overwrite AUX
95	Overwrite AUX ON	Overwrite AUX ON
96	PEAK HOLD On/Off	Peak Hold
97	OSCILLATOR On/Off	OSC ON/OFF
98	SOLO Enable	SOLO ENABLE
99	Control Room Monitor MONO	C-R MONO
100	Pan / Surround Link	PAN/SURR LINK
101	Talkback Assign SLOT1-XX	Talkback SLOT1-XX
102	Talkback Assign SLOT2-XX	Talkback SLOT2-XX
103	Talkback Assign OMNI OUT XX	Talkback OMNI XX
104	Channel Name ID/Short	CH ID/Short
105	Port Name ID/Short	Port D/Short
106	Channel Copy	Channel Copy
107	Channel Paste	Channel Paste
108	Display Back	Display Back
109	Display Forward	Display Forward
110	UDEF KEYS BANK +1	UDEF KEYS BANK+1
111	UDEF KEYS BANK -1	UDEF KEYS BANK-1
112	UDEF KEYS BANK X	UDEF KEYS BANK x
113	MIDI NOTE No.XX	MIDI NOTE XXX
114	MIDI Program change No.XX	MIDI PGM XXX
115	MIDI Control Change No.XX	MIDI CC XXX
116	Machine REC	Machine REC
117	Machine PLAY	Machine PLAY
118	Machine STOP	Machine STOP
119	Machine FF	Machine FF
120	Machine REW	Machine REW
121	Machine SHUTTLE	Machine SHUTTLE
122	Machine SCRUB	Machine SCRUB
123	Machine LOCATE X	Machine LOCATE X
124	Machine Set LOCATE X	Machine Capture X
125	Machine RTZ	Machine RTZ
126	Machine Set RTZ	Machine Set RTZ
127	Track Arming 1	Track Arming 1
128	Track Arming 2	Track Arming 2
129	Track Arming 3	Track Arming 3
130	Track Arming 4	Track Arming 4
131	Track Arming 5	Track Arming 5
132	Track Arming 6	Track Arming 6
133	Track Arming 7	Track Arming 7
134	Track Arming 8	Track Arming 8
135	Track Arming 9	Track Arming 9
136	Track Arming 10	Track Arming 10
137	Track Arming 11	Track Arming 11
138	Track Arming 12	Track Arming 12
139	Track Arming 13	Track Arming 13
140	Track Arming 14	Track Arming 14
141	Track Arming 15	Track Arming 15
142	Track Arming 16	Track Arming 16
143	Track Arming 17	Track Arming 17
144	Track Arming 18	Track Arming 18
145	Track Arming 19	Track Arming 19
146	Track Arming 20	Track Arming 20
147	Track Arming 21	Track Arming 21
148	Track Arming 22	Track Arming 22
149	Track Arming 23	Track Arming 23
150	Track Arming 24	Track Arming 24

#	Function	Display
151	Track Arming All Clear	Track Arming CLR
152	DAW REC	DAW REC
153	DAW PLAY	DAW PLAY
154	DAW STOP	DAW STOP
155	DAW FF	DAW FF
156	DAW REW	DAW REW
157	DAW SHUTTLE	DAW SHUTTLE
158	DAW SCRUB	DAW SCRUB
159	DAW AUDITION	DAW AUDITION
160	DAW PRE	DAW PRE
161	DAW IN	DAW IN
162	DAW OUT	DAW OUT
163	DAW POST	DAW POST
164	DAW RTZ	DAW RTZ
165	DAW END	DAW END
166	DAW ONLINE	DAW ONLINE
167	DAW LOOP	DAW LOOP
168	DAW QUICKPUNCH	DAW QUICKPUNCH
169	DAW GROUP STATUS	DAW GROUP STATUS
170	DAW AUTO FADER	DAW AUTO FADER
171	DAW AUTO MUTE	DAW AUTO MUTE
172	DAW AUTO PAN	DAW AUTO PAN
173	DAW AUTO SEND	DAW AUTO SEND
174	DAW AUTO PLUGIN	DAW AUTO PLUGIN
175	DAW AUTO SEND MUTE	DAW AUTO SEND-MUTE
176	DAW AUTO READ	DAW AUTO READ
177	DAW AUTO TOUCH	DAW AUTO TOUCH
178	DAW AUTO LATCH	DAW AUTO LATCH
179	DAW AUTO WRITE	DAW AUTO WRITE
180	DAW AUTO TRIM	DAW AUTO TRIM
181	DAW AUTO OFF	DAW AUTO OFF
182	DAW AUTO SUSPEND	DAW AUTO SUSPEND
183	DAW AUTO STATUS	DAW AUTO STATUS
184	DAW MONITOR STATUS	DAW MONI STATUS
185	DAW CREATE GROUP	DAW CREATE GROUP
186	DAW SUSPEND GROUP	DAW SUSPEND GRP
187	DAW WINDOW TRANSPORT	DAW WIN TRANSPORT
188	DAW WINDOW INSERT	DAW WIN INSERT
189	DAW WINDOW MIX/EDIT	DAW WIN MIX/EDIT
190	DAW WINDOW MEM-LOC	DAW WIN MEM-LOC
191	DAW WINDOW STATUS	DAW WIN STATUS
192	DAW Shortcut UNDO	DAW UNDO
193	DAW Shortcut SAVE	DAW SAVE
194	DAW Shortcut EDIT MODE	DAW EDIT MODE
195	DAW Shortcut EDIT TOOL	DAW EDIT TOOL
196	DAW Shortcut SHIFT/ADD	DAW SHIFT/ADD
197	DAW Shortcut OPTION/ALL	DAW OPTION/ALL
198	DAW Shortcut CTRL/CLUCH	DAW CTRL/CLUCH
199	DAW Shortcut ALT/FINE	DAW ALT/FINE
200	DAW BANK +	DAW BANK +
201	DAW BANK -	DAW BANK -
202	DAW Channel +	DAW Channel +
203	DAW Channel -	DAW Channel -
204	DAW REC/RDY X	DAW REC/RDY X
205	DAW REC/RDY ALL	DAW REC/RDY ALL

## USER DEFINED KEYS Initial Assignments

	<b>BANK A</b>	<b>BANK B</b>	<b>BANK C</b>	<b>BANK D</b>
<b>TITLE</b>	Surround Monitor	Scene Recall	Group Enable	Automix
<b>1</b>	Snap to SPL85	Scene 1 Recall	IN Fader Group A	Automix ENABLE
<b>2</b>	Bass Manage ON	Scene 2 Recall	IN Mute Group I	Overwrite FADER
<b>3</b>	Surr.Mon L Mute	Scene 3 Recall	IN Fader Group B	Overwrite ON
<b>4</b>	Surr.Mon R Mute	Scene 4 Recall	IN Mute Group J	Overwrite PAN
<b>5</b>	Surr.Mon C Mute	Scene 5 Recall	IN Fader Group C	Overwrite SURR
<b>6</b>	Surr.Mon Bs Mute	Scene 6 Recall	IN Mute Group K	Overwrite AUX
<b>7</b>	Surr.Mon Ls Mute	Scene 7 Recall	IN Fader Group D	Overwrite AUX ON
<b>8</b>	Surr.Mon Rs Mute	Scene 8 Recall	IN Mute Group L	Overwrite EQ
<b>9</b>	Surr.Mon LFEMute	Scene 9 Recall	IN Fader Group E	Automix ABORT
<b>10</b>	No Assign	Scene 10 Recall	IN Mute Group M	Automix AUTOREC
<b>11</b>	Surr Lib-1 Recall	Scene _1 Recall	IN Fader Group F	Automix RETURN
<b>12</b>	Surr Lib+1 Recall	Scene +1 Recall	IN Mute Group N	Amx UPDATE TO END

	<b>BANK E</b>	<b>BANK F</b>	<b>BANK G</b>	<b>BANK H</b>
<b>TITLE</b>	DAW 1	DAW 2	Machine Control	Program Change
<b>1</b>	UDEF BANK F	UDEF BANK E	Machine Locate 1	MIDI PGM 1
<b>2</b>	DAW WIN MIX/EDIT	DAW AUTO STATUS	Machine Locate 2	MIDI PGM 2
<b>3</b>	DAW BANK -	DAW BANK -	Machine Locate 3	MIDI PGM 3
<b>4</b>	DAW BANK +	DAW BANK +	Machine Locate 4	MIDI PGM 4
<b>5</b>	DAW CHANNEL -	DAW AUTO READ	Machine SHUTTLE	MIDI PGM 5
<b>6</b>	DAW CHANNEL +	DAW AUTO TOUCH	Machine SCRUB	MIDI PGM 6
<b>7</b>	DAW SHUTTLE	DAW AUTO LATCH	Machine RTZ	MIDI PGM 7
<b>8</b>	DAW SCRUB	DAW AUTO WRITE	Machine REC	MIDI PGM 8
<b>9</b>	DAW STOP	DAW AUTO TRIM	Machine STOP	MIDI PGM 9
<b>10</b>	DAW PLAY	DAW AUTO OFF	Machine PLAY	MIDI PGM 10
<b>11</b>	DAW SHIFT/ADD	DAW AUTO SUSPEND	Machine REW	MIDI PGM 11
<b>12</b>	DAW OPTION/ALL	DAW OPTION/ALL	Machine FF	MIDI PGM 12

## Input Patch Parameters

INPUT		INSERT IN		EFFECT IN		CASCADE	
Port ID	Description	Port ID	Description	Port ID	Description	Port ID	Description
–	NONE	–	NONE	–	NONE	–	NONE
AD1	AD IN 1	AD1	AD IN 1	AUX1	AUX1	AD1	AD IN 1
AD2	AD IN 2	AD2	AD IN 2	AUX2	AUX2	AD2	AD IN 2
AD3	AD IN 3	AD3	AD IN 3	AUX3	AUX3	AD3	AD IN 3
AD4	AD IN 4	AD4	AD IN 4	AUX4	AUX4	AD4	AD IN 4
AD5	AD IN 5	AD5	AD IN 5	AUX5	AUX5	AD5	AD IN 5
AD6	AD IN 6	AD6	AD IN 6	AUX6	AUX6	AD6	AD IN 6
AD7	AD IN 7	AD7	AD IN 7	AUX7	AUX7	AD7	AD IN 7
AD8	AD IN 8	AD8	AD IN 8	AUX8	AUX8	AD8	AD IN 8
AD9	AD IN 9	AD9	AD IN 9	INSCH1	InsertOut-CH1	AD9	AD IN 9
AD10	AD IN 10	AD10	AD IN 10	INSCH2	InsertOut-CH2	AD10	AD IN 10
AD11	AD IN 11	AD11	AD IN 11	INSCH3	InsertOut-CH3	AD11	AD IN 11
AD12	AD IN 12	AD12	AD IN 12	INSCH4	InsertOut-CH4	AD12	AD IN 12
AD13	AD IN 13	AD13	AD IN 13	INSCH5	InsertOut-CH5	AD13	AD IN 13
AD14	AD IN 14	AD14	AD IN 14	INSCH6	InsertOut-CH6	AD14	AD IN 14
AD15	AD IN 15	AD15	AD IN 15	INSCH7	InsertOut-CH7	AD15	AD IN 15
AD16	AD IN 16	AD16	AD IN 16	INSCH8	InsertOut-CH8	AD16	AD IN 16
OMNI1	OMNI IN 1	OMNI1	OMNI IN 1	INSCH9	InsertOut-CH9	OMNI1	OMNI IN 1
OMNI2	OMNI IN 2	OMNI2	OMNI IN 2	INSCH10	InsertOut-CH10	OMNI2	OMNI IN 2
OMNI3	OMNI IN 3	OMNI3	OMNI IN 3	INSCH11	InsertOut-CH11	OMNI3	OMNI IN 3
OMNI4	OMNI IN 4	OMNI4	OMNI IN 4	INSCH12	InsertOut-CH12	OMNI4	OMNI IN 4
S1-1	Slot1 CH1 IN	S1-1	Slot1 CH1 IN	INSCH13	InsertOut-CH13	S1-1	Slot1 CH1 IN
S1-2	Slot1 CH2 IN	S1-2	Slot1 CH2 IN	INSCH14	InsertOut-CH14	S1-2	Slot1 CH2 IN
S1-3	Slot1 CH3 IN	S1-3	Slot1 CH3 IN	INSCH15	InsertOut-CH15	S1-3	Slot1 CH3 IN
S1-4	Slot1 CH4 IN	S1-4	Slot1 CH4 IN	INSCH16	InsertOut-CH16	S1-4	Slot1 CH4 IN
S1-5	Slot1 CH5 IN	S1-5	Slot1 CH5 IN	INSCH17	InsertOut-CH17	S1-5	Slot1 CH5 IN
S1-6	Slot1 CH6 IN	S1-6	Slot1 CH6 IN	INSCH18	InsertOut-CH18	S1-6	Slot1 CH6 IN
S1-7	Slot1 CH7 IN	S1-7	Slot1 CH7 IN	INSCH19	InsertOut-CH19	S1-7	Slot1 CH7 IN
S1-8	Slot1 CH8 IN	S1-8	Slot1 CH8 IN	INSCH20	InsertOut-CH20	S1-8	Slot1 CH8 IN
S1-9	Slot1 CH9 IN	S1-9	Slot1 CH9 IN	INSCH21	InsertOut-CH21	S1-9	Slot1 CH9 IN
S110	Slot1 CH10 IN	S110	Slot1 CH10 IN	INSCH22	InsertOut-CH22	S110	Slot1 CH10 IN
S111	Slot1 CH11 IN	S111	Slot1 CH11 IN	INSCH23	InsertOut-CH23	S111	Slot1 CH11 IN
S112	Slot1 CH12 IN	S112	Slot1 CH12 IN	INSCH24	InsertOut-CH24	S112	Slot1 CH12 IN
S113	Slot1 CH13 IN	S113	Slot1 CH13 IN	INSCH25	InsertOut-CH25	S113	Slot1 CH13 IN
S114	Slot1 CH14 IN	S114	Slot1 CH14 IN	INSCH26	InsertOut-CH26	S114	Slot1 CH14 IN
S115	Slot1 CH15 IN	S115	Slot1 CH15 IN	INSCH27	InsertOut-CH27	S115	Slot1 CH15 IN
S116	Slot1 CH16 IN	S116	Slot1 CH16 IN	INSCH28	InsertOut-CH28	S116	Slot1 CH16 IN
S2-1	Slot2 CH1 IN	S2-1	Slot2 CH1 IN	INSCH29	InsertOut-CH29	S2-1	Slot2 CH1 IN
S2-2	Slot2 CH2 IN	S2-2	Slot2 CH2 IN	INSCH30	InsertOut-CH30	S2-2	Slot2 CH2 IN
S2-3	Slot2 CH3 IN	S2-3	Slot2 CH3 IN	INSCH31	InsertOut-CH31	S2-3	Slot2 CH3 IN
S2-4	Slot2 CH4 IN	S2-4	Slot2 CH4 IN	INSCH32	InsertOut-CH32	S2-4	Slot2 CH4 IN
S2-5	Slot2 CH5 IN	S2-5	Slot2 CH5 IN	INSCH33	InsertOut-CH33	S2-5	Slot2 CH5 IN
S2-6	Slot2 CH6 IN	S2-6	Slot2 CH6 IN	INSCH34	InsertOut-CH34	S2-6	Slot2 CH6 IN
S2-7	Slot2 CH7 IN	S2-7	Slot2 CH7 IN	INSCH35	InsertOut-CH35	S2-7	Slot2 CH7 IN
S2-8	Slot2 CH8 IN	S2-8	Slot2 CH8 IN	INSCH36	InsertOut-CH36	S2-8	Slot2 CH8 IN
S2-9	Slot2 CH9 IN	S2-9	Slot2 CH9 IN	INSCH37	InsertOut-CH37	S2-9	Slot2 CH9 IN
S210	Slot2 CH10 IN	S210	Slot2 CH10 IN	INSCH38	InsertOut-CH38	S210	Slot2 CH10 IN
S211	Slot2 CH11 IN	S211	Slot2 CH11 IN	INSCH39	InsertOut-CH39	S211	Slot2 CH11 IN
S212	Slot2 CH12 IN	S212	Slot2 CH12 IN	INSCH40	InsertOut-CH40	S212	Slot2 CH12 IN
S213	Slot2 CH13 IN	S213	Slot2 CH13 IN	INSCH41	InsertOut-CH41	S213	Slot2 CH13 IN
S214	Slot2 CH14 IN	S214	Slot2 CH14 IN	INSCH42	InsertOut-CH42	S214	Slot2 CH14 IN
S215	Slot2 CH15 IN	S215	Slot2 CH15 IN	INSCH43	InsertOut-CH43	S215	Slot2 CH15 IN
S216	Slot2 CH16 IN	S216	Slot2 CH16 IN	INSCH44	InsertOut-CH44	S216	Slot2 CH16 IN
FX1-1	Effect1 OUT 1	FX1-1	Effect1 OUT 1	INSCH45	InsertOut-CH45	2TD1L	2TR IN Dig.1 L

INPUT		INSERT IN		EFFECT IN		CASCADE	
Port ID	Description	Port ID	Description	Port ID	Description	Port ID	Description
FX1-2	Effect1 OUT 2	FX1-2	Effect1 OUT 2	INS CH46	InsertOut-CH46	2D1R	2TR IN Dig.1 R
FX1-3	Effect1 OUT 3	FX1-3	Effect1 OUT 3	INS CH47	InsertOut-CH47	2D2L	2TR IN Dig.2 L
FX1-4	Effect1 OUT 4	FX1-4	Effect1 OUT 4	INS CH48	InsertOut-CH48	2D2R	2TR IN Dig.2 R
FX1-5	Effect1 OUT 5	FX1-5	Effect1 OUT 5	INS BUS1	InsertOut-BUS1		
FX1-6	Effect1 OUT 6	FX1-6	Effect1 OUT 6	INS BUS2	InsertOut-BUS2		
FX1-7	Effect1 OUT 7	FX1-7	Effect1 OUT 7	INS BUS3	InsertOut-BUS3		
FX1-8	Effect1 OUT 8	FX1-8	Effect1 OUT 8	INS BUS4	InsertOut-BUS4		
FX2-1	Effect2 OUT 1	FX2-1	Effect2 OUT 1	INS BUS5	InsertOut-BUS5		
FX2-2	Effect2 OUT 2	FX2-2	Effect2 OUT 2	INS BUS6	InsertOut-BUS6		
FX3-1	Effect3 OUT 1	FX3-1	Effect3 OUT 1	INS BUS7	InsertOut-BUS7		
FX3-2	Effect3 OUT 2	FX3-2	Effect3 OUT 2	INS BUS8	InsertOut-BUS8		
FX4-1	Effect4 OUT 1	FX4-1	Effect4 OUT 1	INS AUX1	InsertOut-AUX1		
FX4-2	Effect4 OUT 2	FX4-2	Effect4 OUT 2	INS AUX2	InsertOut-AUX2		
2D1L	2TR IN Dig.1 L	2D1L	2TR IN Dig.1 L	INS AUX3	InsertOut-AUX3		
2D1R	2TR IN Dig.1 R	2D1R	2TR IN Dig.1 R	INS AUX4	InsertOut-AUX4		
2D2L	2TR IN Dig.2 L	2D2L	2TR IN Dig.2 L	INS AUX5	InsertOut-AUX5		
2D2R	2TR IN Dig.2 R	2D2R	2TR IN Dig.2 R	INS AUX6	InsertOut-AUX6		
BUS1	BUS1			INS AUX7	InsertOut-AUX7		
BUS2	BUS2			INS AUX8	InsertOut-AUX8		
BUS3	BUS3			INS ST-L	InsertOut-STL		
BUS4	BUS4			INS ST-R	InsertOut-STR		
BUS5	BUS5			FX1-1	Effect1 OUT 1		
BUS6	BUS6			FX1-2	Effect1 OUT 2		
BUS7	BUS7			FX1-3	Effect1 OUT 3		
BUS8	BUS8			FX1-4	Effect1 OUT 4		
AUX1	AUX1			FX1-5	Effect1 OUT 5		
AUX2	AUX2			FX1-6	Effect1 OUT 6		
AUX3	AUX3			FX1-7	Effect1 OUT 7		
AUX4	AUX4			FX1-8	Effect1 OUT 8		
AUX5	AUX5			FX2-1	Effect2 OUT 1		
AUX6	AUX6			FX2-2	Effect2 OUT 2		
AUX7	AUX7			FX3-1	Effect3 OUT 1		
AUX8	AUX8			FX3-2	Effect3 OUT 2		
				FX4-1	Effect4 OUT 1		
				FX4-2	Effect4 OUT 2		

## Initial Input Patch Settings

### CHANNEL

1	AD1
2	AD2
3	AD3
4	AD4
5	AD5
6	AD6
7	AD7
8	AD8
9	AD9
10	AD10
11	AD11
12	AD12
13	AD13
14	AD14
15	AD15
16	AD16
17	S1-1
18	S1-2
19	S1-3
20	S1-4
21	S1-5
22	S1-6
23	S1-7
24	S1-8
25	S2-1
26	S2-2
27	S2-3
28	S2-4
29	S2-5
30	S2-6
31	S2-7
32	S2-8
33	FX1-1
34	FX1-2
35	FX2-1
36	FX2-2
37	FX3-1
38	FX3-2
39	FX4-1
40	FX4-2
41	2TD1L
42	2TD1R
43	2TD2L
44	2TD2R
45	OMNI1
46	OMNI2
47	OMNI3
48	OMNI4

### EFFECT IN PATCH

1-1	AUX1
1-2	NONE
1-3	NONE
1-4	NONE
1-5	NONE
1-6	NONE
1-7	NONE
1-8	NONE
2-1	AUX2
2-2	NONE
3-1	AUX3
3-2	NONE
4-1	AUX4
4-2	NONE

### CASCADE IN PATCH

BUS1	NONE
BUS2	NONE
BUS3	NONE
BUS4	NONE
BUS5	NONE
BUS6	NONE
BUS7	NONE
BUS8	NONE
AUX1	NONE
AUX2	NONE
AUX3	NONE
AUX4	NONE
AUX56	NONE
AUX6	NONE
AUX7	NONE
AUX8	NONE
ST L	NONE
ST R	NONE
SOLO L	NONE
SOLO R	NONE

### EFFECT TYPE

EFFECT1	REVERB HALL
EFFECT2	REVERB ROOM
EFFECT3	REVERB STAGE
EFFECT4	REVERB PLATE

(mono input)



**CHANNEL NAME**

	CHANNEL ID	SHORT	LONG
CH1	CH1	CH1	CH1
CH2	CH2	CH2	CH2
CH3	CH3	CH3	CH3
CH4	CH4	CH4	CH4
CH5	CH5	CH5	CH5
CH6	CH6	CH6	CH6
CH7	CH7	CH7	CH7
CH8	CH8	CH8	CH8
CH9	CH9	CH9	CH9
CH10	CH10	CH10	CH10
CH11	CH11	CH11	CH11
CH12	CH12	CH12	CH12
CH13	CH13	CH13	CH13
CH14	CH14	CH14	CH14
CH15	CH15	CH15	CH15
CH16	CH16	CH16	CH16
CH17	CH17	CH17	CH17
CH18	CH18	CH18	CH18
CH19	CH19	CH19	CH19
CH20	CH20	CH20	CH20
CH21	CH21	CH21	CH21
CH22	CH22	CH22	CH22
CH23	CH23	CH23	CH23
CH24	CH24	CH24	CH24
CH25	CH25	CH25	CH25
CH26	CH26	CH26	CH26
CH27	CH27	CH27	CH27
CH28	CH28	CH28	CH28
CH29	CH29	CH29	CH29
CH30	CH30	CH30	CH30
CH31	CH31	CH31	CH31
CH32	CH32	CH32	CH32
CH33	CH33	CH33	CH33
CH34	CH34	CH34	CH34
CH35	CH35	CH35	CH35
CH36	CH36	CH36	CH36
CH37	CH37	CH37	CH37
CH38	CH38	CH38	CH38
CH39	CH39	CH39	CH39
CH40	CH40	CH40	CH40
CH41	CH41	CH41	CH41
CH42	CH42	CH42	CH42
CH43	CH43	CH43	CH43
CH44	CH44	CH44	CH44
CH45	CH45	CH45	CH45
CH46	CH46	CH46	CH46
CH47	CH47	CH47	CH47
CH48	CH48	CH48	CH48

## Output Patch Parameters

SLOT, OMNI		INSERT IN		DIRECT OUT		2TR OUT Digital	
Source	Description	Source	Description	Source	Description	Source	Description
–	NONE	–	NONE	–	NONE	–	NONE
BUS1	BUS1	AD1	AD IN 1	S1-1	Slot1 CH1 OUT	BUS1	BUS1
BUS2	BUS2	AD2	AD IN 2	S1-2	Slot1 CH2 OUT	BUS2	BUS2
BUS3	BUS3	AD3	AD IN 3	S1-3	Slot1 CH3 OUT	BUS3	BUS3
BUS4	BUS4	AD4	AD IN 4	S1-4	Slot1 CH4 OUT	BUS4	BUS4
BUS5	BUS5	AD5	AD IN 5	S1-5	Slot1 CH5 OUT	BUS5	BUS5
BUS6	BUS6	AD6	AD IN 6	S1-6	Slot1 CH6 OUT	BUS6	BUS6
BUS7	BUS7	AD7	AD IN 7	S1-7	Slot1 CH7 OUT	BUS7	BUS7
BUS8	BUS8	AD8	AD IN 8	S1-8	Slot1 CH8 OUT	BUS8	BUS8
AUX1	AUX1	AD9	AD IN 9	S1-9	Slot1 CH9 OUT	AUX1	AUX1
AUX2	AUX2	AD10	AD IN 10	S110	Slot1 CH10 OUT	AUX2	AUX2
AUX3	AUX3	AD11	AD IN 11	S111	Slot1 CH11 OUT	AUX3	AUX3
AUX4	AUX4	AD12	AD IN 12	S112	Slot1 CH12 OUT	AUX4	AUX4
AUX5	AUX5	AD13	AD IN 13	S113	Slot1 CH13 OUT	AUX5	AUX5
AUX6	AUX6	AD14	AD IN 14	S114	Slot1 CH14 OUT	AUX6	AUX6
AUX7	AUX7	AD15	AD IN 15	S115	Slot1 CH15 OUT	AUX7	AUX7
AUX8	AUX8	AD16	AD IN 16	S116	Slot1 CH16 OUT	AUX8	AUX8
STEREO-L	STEREO L	OMNI1	OMNI IN 1	S2-1	Slot2 CH1 OUT	STEREO-L	STEREO L
STEREO-R	STEREO R	OMNI2	OMNI IN 2	S2-2	Slot2 CH2 OUT	STEREO-R	STEREO R
INSCH1	InsertOut-CH1	OMNI3	OMNI IN 3	S2-3	Slot2 CH3 OUT	INSCH1	InsertOut-CH1
INSCH2	InsertOut-CH2	OMNI4	OMNI IN 4	S2-4	Slot2 CH4 OUT	INSCH2	InsertOut-CH2
INSCH3	InsertOut-CH3	S1-1	Slot1 CH1 IN	S2-5	Slot2 CH5 OUT	INSCH3	InsertOut-CH3
INSCH4	InsertOut-CH4	S1-2	Slot1 CH2 IN	S2-6	Slot2 CH6 OUT	INSCH4	InsertOut-CH4
INSCH5	InsertOut-CH5	S1-3	Slot1 CH3 IN	S2-7	Slot2 CH7 OUT	INSCH5	InsertOut-CH5
INSCH6	InsertOut-CH6	S1-4	Slot1 CH4 IN	S2-8	Slot2 CH8 OUT	INSCH6	InsertOut-CH6
INSCH7	InsertOut-CH7	S1-5	Slot1 CH5 IN	S2-9	Slot2 CH9 OUT	INSCH7	InsertOut-CH7
INSCH8	InsertOut-CH8	S1-6	Slot1 CH6 IN	S210	Slot2 CH10 OUT	INSCH8	InsertOut-CH8
INSCH9	InsertOut-CH9	S1-7	Slot1 CH7 IN	S211	Slot2 CH11 OUT	INSCH9	InsertOut-CH9
INSCH10	InsertOut-CH10	S1-8	Slot1 CH8 IN	S212	Slot2 CH12 OUT	INSCH10	InsertOut-CH10
INSCH11	InsertOut-CH11	S1-9	Slot1 CH9 IN	S213	Slot2 CH13 OUT	INSCH11	InsertOut-CH11
INSCH12	InsertOut-CH12	S110	Slot1 CH10 IN	S214	Slot2 CH14 OUT	INSCH12	InsertOut-CH12
INSCH13	InsertOut-CH13	S111	Slot1 CH11 IN	S215	Slot2 CH15 OUT	INSCH13	InsertOut-CH13
INSCH14	InsertOut-CH14	S112	Slot1 CH12 IN	S216	Slot2 CH16 OUT	INSCH14	InsertOut-CH14
INSCH15	InsertOut-CH15	S113	Slot1 CH13 IN	OMNI1	OMNI OUT 1	INSCH15	InsertOut-CH15
INSCH16	InsertOut-CH16	S114	Slot1 CH14 IN	OMNI2	OMNI OUT 2	INSCH16	InsertOut-CH16
INSCH17	InsertOut-CH17	S115	Slot1 CH15 IN	OMNI3	OMNI OUT 3	INSCH17	InsertOut-CH17
INSCH18	InsertOut-CH18	S116	Slot1 CH16 IN	OMNI4	OMNI OUT 4	INSCH18	InsertOut-CH18
INSCH19	InsertOut-CH19	S2-1	Slot2 CH1 IN	OMNI5	OMNI OUT 5	INSCH19	InsertOut-CH19
INSCH20	InsertOut-CH20	S2-2	Slot2 CH2 IN	OMNI6	OMNI OUT 6	INSCH20	InsertOut-CH20
INSCH21	InsertOut-CH21	S2-3	Slot2 CH3 IN	OMNI7	OMNI OUT 7	INSCH21	InsertOut-CH21
INSCH22	InsertOut-CH22	S2-4	Slot2 CH4 IN	OMNI8	OMNI OUT 8	INSCH22	InsertOut-CH22
INSCH23	InsertOut-CH23	S2-5	Slot2 CH5 IN	2TD1L	2TR OUT Dig.1 L	INSCH23	InsertOut-CH23
INSCH24	InsertOut-CH24	S2-6	Slot2 CH6 IN	2TD1R	2TR OUT Dig.1 R	INSCH24	InsertOut-CH24
INSCH25	InsertOut-CH25	S2-7	Slot2 CH7 IN	2TD2L	2TR OUT Dig.2 L	INSCH25	InsertOut-CH25
INSCH26	InsertOut-CH26	S2-8	Slot2 CH8 IN	2TD2R	2TR OUT Dig.2 R	INSCH26	InsertOut-CH26
INSCH27	InsertOut-CH27	S2-9	Slot2 CH9 IN	OMNI9	OMNI OUT 9	INSCH27	InsertOut-CH27
INSCH28	InsertOut-CH28	S210	Slot2 CH10 IN	OMNI10	OMNI OUT 10	INSCH28	InsertOut-CH28
INSCH29	InsertOut-CH29	S211	Slot2 CH11 IN	OMNI11	OMNI OUT 11	INSCH29	InsertOut-CH29
INSCH30	InsertOut-CH30	S212	Slot2 CH12 IN	OMNI12	OMNI OUT 12	INSCH30	InsertOut-CH30
INSCH31	InsertOut-CH31	S213	Slot2 CH13 IN	—	—	INSCH31	InsertOut-CH31
INSCH32	InsertOut-CH32	S214	Slot2 CH14 IN	—	—	INSCH32	InsertOut-CH32
INSCH33	InsertOut-CH33	S215	Slot2 CH15 IN	—	—	INSCH33	InsertOut-CH33
INSCH34	InsertOut-CH34	S216	Slot2 CH16 IN	—	—	INSCH34	InsertOut-CH34
INSCH35	InsertOut-CH35	FX1-1	Effect1 OUT 1	—	—	INSCH35	InsertOut-CH35

SLOT, OMNI		INSERT IN		DIRECT OUT		2TR OUT Digital	
Source	Description	Source	Description	Source	Description	Source	Description
INSCH36	InsertOut-CH36	FX1-2	Effect1 OUT 2	—	—	INSCH36	InsertOut-CH36
INSCH37	InsertOut-CH37	FX1-3	Effect1 OUT 3	—	—	INSCH37	InsertOut-CH37
INSCH38	InsertOut-CH38	FX1-4	Effect1 OUT 4	—	—	INSCH38	InsertOut-CH38
INSCH39	InsertOut-CH39	FX1-5	Effect1 OUT 5	—	—	INSCH39	InsertOut-CH39
INSCH40	InsertOut-CH40	FX1-6	Effect1 OUT 6	—	—	INSCH40	InsertOut-CH40
INSCH41	InsertOut-CH41	FX1-7	Effect1 OUT 7	—	—	INSCH41	InsertOut-CH41
INSCH42	InsertOut-CH42	FX1-8	Effect1 OUT 8	—	—	INSCH42	InsertOut-CH42
INSCH43	InsertOut-CH43	FX2-1	Effect2 OUT 1	—	—	INSCH43	InsertOut-CH43
INSCH44	InsertOut-CH44	FX2-2	Effect2 OUT 2	—	—	INSCH44	InsertOut-CH44
INSCH45	InsertOut-CH45	FX3-1	Effect3 OUT 1	—	—	INSCH45	InsertOut-CH45
INSCH46	InsertOut-CH46	FX3-2	Effect3 OUT 2	—	—	INSCH46	InsertOut-CH46
INSCH47	InsertOut-CH47	FX4-1	Effect4 OUT 1	—	—	INSCH47	InsertOut-CH47
INSCH48	InsertOut-CH48	FX4-2	Effect4 OUT 2	—	—	INSCH48	InsertOut-CH48
INSBUS1	InsertOut-BUS1	2TD1L	2TR IN Dig.1 L	—	—	INSBUS1	InsertOut-BUS1
INSBUS2	InsertOut-BUS2	2TD1R	2TR IN Dig.1 R	—	—	INSBUS2	InsertOut-BUS2
INSBUS3	InsertOut-BUS3	2TD2L	2TR IN Dig.2 L	—	—	INSBUS3	InsertOut-BUS3
INSBUS4	InsertOut-BUS4	2TD2R	2TR IN Dig.2 R	—	—	INSBUS4	InsertOut-BUS4
INSBUS5	InsertOut-BUS5	—	—	—	—	INSBUS5	InsertOut-BUS5
INSBUS6	InsertOut-BUS6	—	—	—	—	INSBUS6	InsertOut-BUS6
INSBUS7	InsertOut-BUS7	—	—	—	—	INSBUS7	InsertOut-BUS7
INSBUS8	InsertOut-BUS8	—	—	—	—	INSBUS8	InsertOut-BUS8
INSAUX1	InsertOut-AUX1	—	—	—	—	INSAUX1	InsertOut-AUX1
INSAUX2	InsertOut-AUX2	—	—	—	—	INSAUX2	InsertOut-AUX2
INSAUX3	InsertOut-AUX3	—	—	—	—	INSAUX3	InsertOut-AUX3
INSAUX4	InsertOut-AUX4	—	—	—	—	INSAUX4	InsertOut-AUX4
INSAUX5	InsertOut-AUX5	—	—	—	—	INSAUX5	InsertOut-AUX5
INSAUX6	InsertOut-AUX6	—	—	—	—	INSAUX6	InsertOut-AUX6
INSAUX7	InsertOut-AUX7	—	—	—	—	INSAUX7	InsertOut-AUX7
INSAUX8	InsertOut-AUX8	—	—	—	—	INSAUX8	InsertOut-AUX8
INSSTL	InsertOut-STL	—	—	—	—	INSSTL	InsertOut-STL
INSSTR	InsertOut-STR	—	—	—	—	INSSTR	InsertOut-STR
Surr L	Surr Monitor L	—	—	—	—	CR-L	Control Room L
Surr R	Surr Monitor R	—	—	—	—	CR-R	Control Room R
Surr Ls	Surr Monitor Ls	—	—	—	—	CAS BUS1	Cascade Out Bus1
Surr Rs	Surr Monitor Rs	—	—	—	—	CAS BUS2	Cascade Out Bus2
Surr C	Surr Monitor C	—	—	—	—	CAS BUS3	Cascade Out Bus3
Surr SW	Surr Monitor SW	—	—	—	—	CAS BUS4	Cascade Out Bus4
Surr Ls2	Surr Monitor Ls2	—	—	—	—	CAS BUS5	Cascade Out Bus5
Surr Rs2	Surr Monitor Rs2	—	—	—	—	CAS BUS6	Cascade Out Bus6
CR-L	Control Room L	—	—	—	—	CAS BUS7	Cascade Out Bus7
CR-R	Control Room R	—	—	—	—	CAS BUS8	Cascade Out Bus8
CAS BUS1	Cascade Out Bus1	—	—	—	—	CAS AUX1	Cascade Out Aux1
CAS BUS2	Cascade Out Bus2	—	—	—	—	CAS AUX2	Cascade Out Aux2
CAS BUS3	Cascade Out Bus3	—	—	—	—	CAS AUX3	Cascade Out Aux3
CAS BUS4	Cascade Out Bus4	—	—	—	—	CAS AUX4	Cascade Out Aux4
CAS BUS5	Cascade Out Bus5	—	—	—	—	CAS AUX5	Cascade Out Aux5
CAS BUS6	Cascade Out Bus6	—	—	—	—	CAS AUX6	Cascade Out Aux6
CAS BUS7	Cascade Out Bus7	—	—	—	—	CAS AUX7	Cascade Out Aux7
CAS BUS8	Cascade Out Bus8	—	—	—	—	CAS AUX8	Cascade Out Aux8
CAS AUX1	Cascade Out Aux1	—	—	—	—	CAS ST_L	Cascade STEREO_L
CAS AUX2	Cascade Out Aux2	—	—	—	—	CAS ST_R	Cascade STEREO_R
CAS AUX3	Cascade Out Aux3	—	—	—	—	CAS SO_L	Cascade SOLO_L
CAS AUX4	Cascade Out Aux4	—	—	—	—	CAS SO_R	Cascade SOLO_R
CAS AUX5	Cascade Out Aux5	—	—	—	—	SOLO L	SOLO OUT L
CAS AUX6	Cascade Out Aux6	—	—	—	—	SOLO R	SOLO OUT R
CAS AUX7	Cascade Out Aux7	—	—	—	—	—	—

SLOT, OMNI		INSERT IN		DIRECT OUT		2TR OUT Digital	
Source	Description	Source	Description	Source	Description	Source	Description
CAS AUX8	Cascade Out Aux8	—	—	—	—	—	—
CAS ST_L	Cascade STEREO_L	—	—	—	—	—	—
CAS ST_R	Cascade STEREO_R	—	—	—	—	—	—
CAS SO_L	Cascade SOLO_L	—	—	—	—	—	—
CAS SO_R	Cascade SOLO_R	—	—	—	—	—	—
SOLO L	SOLO OUT L	—	—	—	—	—	—
SOLO R	SOLO OUT R	—	—	—	—	—	—
Moni L	Moni Matrix L	—	—	—	—	—	—
Moni R	Moni Matrix R	—	—	—	—	—	—
Moni Ls	Moni Matrix Ls	—	—	—	—	—	—
Moni Rs	Moni Matrix Rs	—	—	—	—	—	—
Moni C	Moni Matrix C	—	—	—	—	—	—
Moni Bs	Moni Matrix Bs	—	—	—	—	—	—
Moni LFE	Moni Matrix LFE	—	—	—	—	—	—

## Initial Output Patch Settings

### SLOT

SLOT1-1	BUS1
SLOT1-2	BUS2
SLOT1-3	BUS3
SLOT1-4	BUS4
SLOT1-5	BUS5
SLOT1-6	BUS6
SLOT1-7	BUS7
SLOT1-8	BUS8
SLOT1-9	BUS1
SLOT1-10	BUS2
SLOT1-11	BUS3
SLOT1-12	BUS4
SLOT1-13	BUS5
SLOT1-14	BUS6
SLOT1-15	BUS7
SLOT1-16	BUS8
SLOT2-1	BUS1
SLOT2-2	BUS2
SLOT2-3	BUS3
SLOT2-4	BUS4
SLOT2-5	BUS5
SLOT2-6	BUS6
SLOT2-7	BUS7
SLOT2-8	BUS8
SLOT2-9	BUS1
SLOT2-10	BUS2
SLOT2-11	BUS3
SLOT2-12	BUS4
SLOT2-13	BUS5
SLOT2-14	BUS6
SLOT2-15	BUS7
SLOT2-16	BUS8

### OMNI OUT

1	AUX1
2	AUX2
3	AUX3
4	AUX4
5	AUX5
6	AUX6
7	AUX7
8	AUX8
9	ST L
10	ST R
11	C-R L
12	C-R R

**DIRECT OUT**

1	SLOT1-1
2	SLOT1-2
3	SLOT1-3
4	SLOT1-4
5	SLOT1-5
6	SLOT1-6
7	SLOT1-7
8	SLOT1-8
9	SLOT2-1
10	SLOT2-2
11	SLOT2-3
12	SLOT2-4
13	SLOT2-5
14	SLOT2-6
15	SLOT2-7
16	SLOT2-8
17	NONE
18	NONE
19	NONE
20	NONE
21	NONE
22	NONE
23	NONE
24	NONE
25	NONE
26	NONE
27	NONE
28	NONE
29	NONE
30	NONE
31	NONE
32	NONE
33	NONE
34	NONE
35	NONE
36	NONE
37	NONE
38	NONE
39	NONE
40	NONE
41	NONE
42	NONE
43	NONE
44	NONE
45	NONE
46	NONE
47	NONE
48	NONE

ST IN has no DIRECT OUT

**2TR OUT Digital**

1L	ST L
1R	ST R
2L	ST L
2R	ST R

**CHANNEL NAME**

	CHANNEL ID	SHORT	LONG
AUX1	AUX1	AUX1	AUX1
AUX2	AUX2	AUX2	AUX2
AUX3	AUX3	AUX3	AUX3
AUX4	AUX4	AUX4	AUX4
AUX5	AUX5	AUX5	AUX5
AUX6	AUX6	AUX6	AUX6
AUX7	AUX7	AUX7	AUX7
AUX8	AUX8	AUX8	AUX8
BUS1	BUS1	BUS1	BUS1
BUS2	BUS2	BUS2	BUS2
BUS3	BUS3	BUS3	BUS3
BUS4	BUS4	BUS4	BUS4
BUS5	BUS5	BUS5	BUS5
BUS6	BUS6	BUS6	BUS6
BUS7	BUS7	BUS7	BUS7
BUS8	BUS8	BUS8	BUS8
STEREO	ST	ST	STEREO

## GPI Trigger Source List

#	Source	#	Source	#	Source	#	Source
0	NO ASSIGN	53	CH53 FADER ON	106	CH33 FADER OFF	159	UDEF13 LATCH
1	CH1 FADER ON	54	CH54 FADER ON	107	CH34 FADER OFF	160	UDEF14 LATCH
2	CH2 FADER ON	55	CH55 FADER ON	108	CH35 FADER OFF	161	UDEF15 LATCH
3	CH3 FADER ON	56	CH56 FADER ON	109	CH36 FADER OFF	162	UDEF16 LATCH
4	CH4 FADER ON	57	BUS1 FADER ON	110	CH37 FADER OFF	163	UDEF1 UNLATCH
5	CH5 FADER ON	58	BUS2 FADER ON	111	CH38 FADER OFF	164	UDEF2 UNLATCH
6	CH6 FADER ON	59	BUS3 FADER ON	112	CH39 FADER OFF	165	UDEF3 UNLATCH
7	CH7 FADER ON	60	BUS4 FADER ON	113	CH40 FADER OFF	166	UDEF4 UNLATCH
8	CH8 FADER ON	61	BUS5 FADER ON	114	CH41 FADER OFF	167	UDEF5 UNLATCH
9	CH9 FADER ON	62	BUS6 FADER ON	115	CH42 FADER OFF	168	UDEF6 UNLATCH
10	CH10 FADER ON	63	BUS7 FADER ON	116	CH43 FADER OFF	169	UDEF7 UNLATCH
11	CH11 FADER ON	64	BUS8 FADER ON	117	CH44 FADER OFF	170	UDEF8 UNLATCH
12	CH12 FADER ON	65	AUX1 FADER ON	118	CH45 FADER OFF	171	UDEF9 UNLATCH
13	CH13 FADER ON	66	AUX2 FADER ON	119	CH46 FADER OFF	172	UDEF10 UNLATCH
14	CH14 FADER ON	67	AUX3 FADER ON	120	CH47 FADER OFF	173	UDEF11 UNLATCH
15	CH15 FADER ON	68	AUX4 FADER ON	121	CH48 FADER OFF	174	UDEF12 UNLATCH
16	CH16 FADER ON	69	AUX5 FADER ON	122	CH49 FADER OFF	175	UDEF13 UNLATCH
17	CH17 FADER ON	70	AUX6 FADER ON	123	CH50 FADER OFF	176	UDEF14 UNLATCH
18	CH18 FADER ON	71	AUX7 FADER ON	124	CH51 FADER OFF	177	UDEF15 UNLATCH
19	CH19 FADER ON	72	AUX8 FADER ON	125	CH52 FADER OFF	178	UDEF16 UNLATCH
20	CH20 FADER ON	73	STEREO FADER ON	126	CH53 FADER OFF	179	REC LAMP
21	CH21 FADER ON	74	CH1 FADER OFF	127	CH54 FADER OFF	180	POWER ON
22	CH22 FADER ON	75	CH2 FADER OFF	128	CH55 FADER OFF		
23	CH23 FADER ON	76	CH3 FADER OFF	129	CH56 FADER OFF		
24	CH24 FADER ON	77	CH4 FADER OFF	130	BUS1 FADER OFF		
25	CH25 FADER ON	78	CH5 FADER OFF	131	BUS2 FADER OFF		
26	CH26 FADER ON	79	CH6 FADER OFF	132	BUS3 FADER OFF		
27	CH27 FADER ON	80	CH7 FADER OFF	133	BUS4 FADER OFF		
28	CH28 FADER ON	81	CH8 FADER OFF	134	BUS5 FADER OFF		
29	CH29 FADER ON	82	CH9 FADER OFF	135	BUS6 FADER OFF		
30	CH30 FADER ON	83	CH10 FADER OFF	136	BUS7 FADER OFF		
31	CH31 FADER ON	84	CH11 FADER OFF	137	BUS8 FADER OFF		
32	CH32 FADER ON	85	CH12 FADER OFF	138	AUX1 FADER OFF		
33	CH33 FADER ON	86	CH13 FADER OFF	139	AUX2 FADER OFF		
34	CH34 FADER ON	87	CH14 FADER OFF	140	AUX3 FADER OFF		
35	CH35 FADER ON	88	CH15 FADER OFF	141	AUX4 FADER OFF		
36	CH36 FADER ON	89	CH16 FADER OFF	142	AUX5 FADER OFF		
37	CH37 FADER ON	90	CH17 FADER OFF	143	AUX6 FADER OFF		
38	CH38 FADER ON	91	CH18 FADER OFF	144	AUX7 FADER OFF		
39	CH39 FADER ON	92	CH19 FADER OFF	145	AUX8 FADER OFF		
40	CH40 FADER ON	93	CH20 FADER OFF	146	STEREO FADER OFF		
41	CH41 FADER ON	94	CH21 FADER OFF	147	UDEF1 LATCH		
42	CH42 FADER ON	95	CH22 FADER OFF	148	UDEF2 LATCH		
43	CH43 FADER ON	96	CH23 FADER OFF	149	UDEF3 LATCH		
44	CH44 FADER ON	97	CH24 FADER OFF	150	UDEF4 LATCH		
45	CH45 FADER ON	98	CH25 FADER OFF	151	UDEF5 LATCH		
46	CH46 FADER ON	99	CH26 FADER OFF	152	UDEF6 LATCH		
47	CH47 FADER ON	100	CH27 FADER OFF	153	UDEF7 LATCH		
48	CH48 FADER ON	101	CH28 FADER OFF	154	UDEF8 LATCH		
49	CH49 FADER ON	102	CH29 FADER OFF	155	UDEF9 LATCH		
50	CH50 FADER ON	103	CH30 FADER OFF	156	UDEF10 LATCH		
51	CH51 FADER ON	104	CH31 FADER OFF	157	UDEF11 LATCH		
52	CH52 FADER ON	105	CH32 FADER OFF	158	UDEF12 LATCH		

## User Defined Remote Layer Initial Bank Settings

### Bank 1 (GM Vol & Pan)

ID	Name		Controller	Data Format																
	Short	Long		1	2	3	4	5	6	7	8	9	10	11	12	13	14	15	16	
RM01	GM01	GM-CH01 VOL&PAN	ON	END	-	-	-	-	-	-	-	-	-	-	-	-	-	-	-	
			ENCODER	B0	0A	ENC	END	-	-	-	-	-	-	-	-	-	-	-	-	-
			FADER	B0	07	FAD	END	-	-	-	-	-	-	-	-	-	-	-	-	-
RM02	GM02	GM-CH02 VOL&PAN	ON	END	-	-	-	-	-	-	-	-	-	-	-	-	-	-	-	
			ENCODER	B1	0A	ENC	END	-	-	-	-	-	-	-	-	-	-	-	-	-
			FADER	B1	07	FAD	END	-	-	-	-	-	-	-	-	-	-	-	-	-
RM03	GM03	GM-CH03 VOL&PAN	ON	END	-	-	-	-	-	-	-	-	-	-	-	-	-	-	-	
			ENCODER	B2	0A	ENC	END	-	-	-	-	-	-	-	-	-	-	-	-	-
			FADER	B2	07	FAD	END	-	-	-	-	-	-	-	-	-	-	-	-	-
RM04	GM04	GM-CH04 VOL&PAN	ON	END	-	-	-	-	-	-	-	-	-	-	-	-	-	-	-	
			ENCODER	B3	0A	ENC	END	-	-	-	-	-	-	-	-	-	-	-	-	-
			FADER	B3	07	FAD	END	-	-	-	-	-	-	-	-	-	-	-	-	-
RM05	GM05	GM-CH05 VOL&PAN	ON	END	-	-	-	-	-	-	-	-	-	-	-	-	-	-	-	
			ENCODER	B4	0A	ENC	END	-	-	-	-	-	-	-	-	-	-	-	-	-
			FADER	B4	07	FAD	END	-	-	-	-	-	-	-	-	-	-	-	-	-
RM06	GM06	GM-CH06 VOL&PAN	ON	END	-	-	-	-	-	-	-	-	-	-	-	-	-	-	-	
			ENCODER	B5	0A	ENC	END	-	-	-	-	-	-	-	-	-	-	-	-	-
			FADER	B5	07	FAD	END	-	-	-	-	-	-	-	-	-	-	-	-	-
RM07	GM07	GM-CH07 VOL&PAN	ON	END	-	-	-	-	-	-	-	-	-	-	-	-	-	-	-	
			ENCODER	B6	0A	ENC	END	-	-	-	-	-	-	-	-	-	-	-	-	-
			FADER	B6	07	FAD	END	-	-	-	-	-	-	-	-	-	-	-	-	-
RM08	GM08	GM-CH08 VOL&PAN	ON	END	-	-	-	-	-	-	-	-	-	-	-	-	-	-	-	
			ENCODER	B7	0A	ENC	END	-	-	-	-	-	-	-	-	-	-	-	-	-
			FADER	B7	07	FAD	END	-	-	-	-	-	-	-	-	-	-	-	-	-
RM09	GM09	GM-CH09 VOL&PAN	ON	END	-	-	-	-	-	-	-	-	-	-	-	-	-	-	-	
			ENCODER	B8	0A	ENC	END	-	-	-	-	-	-	-	-	-	-	-	-	-
			FADER	B8	07	FAD	END	-	-	-	-	-	-	-	-	-	-	-	-	-
RM10	GM10	GM-CH10 VOL&PAN	ON	END	-	-	-	-	-	-	-	-	-	-	-	-	-	-	-	
			ENCODER	B9	0A	ENC	END	-	-	-	-	-	-	-	-	-	-	-	-	-
			FADER	B9	07	FAD	END	-	-	-	-	-	-	-	-	-	-	-	-	-
RM11	GM11	GM-CH11 VOL&PAN	ON	END	-	-	-	-	-	-	-	-	-	-	-	-	-	-	-	
			ENCODER	BA	0A	ENC	END	-	-	-	-	-	-	-	-	-	-	-	-	-
			FADER	BA	07	FAD	END	-	-	-	-	-	-	-	-	-	-	-	-	-
RM12	GM12	GM-CH12 VOL&PAN	ON	END	-	-	-	-	-	-	-	-	-	-	-	-	-	-	-	
			ENCODER	BB	0A	ENC	END	-	-	-	-	-	-	-	-	-	-	-	-	-
			FADER	BB	07	FAD	END	-	-	-	-	-	-	-	-	-	-	-	-	-
RM13	GM13	GM-CH13 VOL&PAN	ON	END	-	-	-	-	-	-	-	-	-	-	-	-	-	-	-	
			ENCODER	BC	0A	ENC	END	-	-	-	-	-	-	-	-	-	-	-	-	-
			FADER	BC	07	FAD	END	-	-	-	-	-	-	-	-	-	-	-	-	-
RM14	GM14	GM-CH14 VOL&PAN	ON	END	-	-	-	-	-	-	-	-	-	-	-	-	-	-	-	
			ENCODER	BD	0A	ENC	END	-	-	-	-	-	-	-	-	-	-	-	-	-
			FADER	BD	07	FAD	END	-	-	-	-	-	-	-	-	-	-	-	-	-
RM15	GM15	GM-CH15 VOL&PAN	ON	END	-	-	-	-	-	-	-	-	-	-	-	-	-	-	-	
			ENCODER	BE	0A	ENC	END	-	-	-	-	-	-	-	-	-	-	-	-	-
			FADER	BE	07	FAD	END	-	-	-	-	-	-	-	-	-	-	-	-	-
RM16	GM16	GM-CH16 VOL&PAN	ON	END	-	-	-	-	-	-	-	-	-	-	-	-	-	-	-	
			ENCODER	BF	0A	ENC	END	-	-	-	-	-	-	-	-	-	-	-	-	-
			FADER	BF	07	FAD	END	-	-	-	-	-	-	-	-	-	-	-	-	-

**Bank 2 (GM Vol & Effect 1)**

ID	Name		Controller	Data Format																
	Short	Long		1	2	3	4	5	6	7	8	9	10	11	12	13	14	15	16	
RM01	GM01	GM-CH01 VOL&EFF1	ON	END	-	-	-	-	-	-	-	-	-	-	-	-	-	-	-	
			ENCODER	B0	0C	ENC	END	-	-	-	-	-	-	-	-	-	-	-	-	-
			FADER	B0	07	FAD	END	-	-	-	-	-	-	-	-	-	-	-	-	-
RM02	GM02	GM-CH02 VOL&EFF1	ON	END	-	-	-	-	-	-	-	-	-	-	-	-	-	-	-	
			ENCODER	B1	0C	ENC	END	-	-	-	-	-	-	-	-	-	-	-	-	-
			FADER	B1	07	FAD	END	-	-	-	-	-	-	-	-	-	-	-	-	-
RM03	GM03	GM-CH03 VOL&EFF1	ON	END	-	-	-	-	-	-	-	-	-	-	-	-	-	-	-	
			ENCODER	B2	0C	ENC	END	-	-	-	-	-	-	-	-	-	-	-	-	-
			FADER	B2	07	FAD	END	-	-	-	-	-	-	-	-	-	-	-	-	-
RM04	GM04	GM-CH04 VOL&EFF1	ON	END	-	-	-	-	-	-	-	-	-	-	-	-	-	-	-	
			ENCODER	B3	0C	ENC	END	-	-	-	-	-	-	-	-	-	-	-	-	-
			FADER	B3	07	FAD	END	-	-	-	-	-	-	-	-	-	-	-	-	-
RM05	GM05	GM-CH05 VOL&EFF1	ON	END	-	-	-	-	-	-	-	-	-	-	-	-	-	-	-	
			ENCODER	B4	0C	ENC	END	-	-	-	-	-	-	-	-	-	-	-	-	-
			FADER	B4	07	FAD	END	-	-	-	-	-	-	-	-	-	-	-	-	-
RM06	GM06	GM-CH06 VOL&EFF1	ON	END	-	-	-	-	-	-	-	-	-	-	-	-	-	-	-	
			ENCODER	B5	0C	ENC	END	-	-	-	-	-	-	-	-	-	-	-	-	-
			FADER	B5	07	FAD	END	-	-	-	-	-	-	-	-	-	-	-	-	-
RM07	GM07	GM-CH07 VOL&EFF1	ON	END	-	-	-	-	-	-	-	-	-	-	-	-	-	-	-	
			ENCODER	B6	0C	ENC	END	-	-	-	-	-	-	-	-	-	-	-	-	-
			FADER	B6	07	FAD	END	-	-	-	-	-	-	-	-	-	-	-	-	-
RM08	GM08	GM-CH08 VOL&EFF1	ON	END	-	-	-	-	-	-	-	-	-	-	-	-	-	-	-	
			ENCODER	B7	0C	ENC	END	-	-	-	-	-	-	-	-	-	-	-	-	-
			FADER	B7	07	FAD	END	-	-	-	-	-	-	-	-	-	-	-	-	-
RM09	GM09	GM-CH09 VOL&EFF1	ON	END	-	-	-	-	-	-	-	-	-	-	-	-	-	-	-	
			ENCODER	B8	0C	ENC	END	-	-	-	-	-	-	-	-	-	-	-	-	-
			FADER	B8	07	FAD	END	-	-	-	-	-	-	-	-	-	-	-	-	-
RM10	GM10	GM-CH10 VOL&EFF1	ON	END	-	-	-	-	-	-	-	-	-	-	-	-	-	-	-	
			ENCODER	B9	0C	ENC	END	-	-	-	-	-	-	-	-	-	-	-	-	-
			FADER	B9	07	FAD	END	-	-	-	-	-	-	-	-	-	-	-	-	-
RM11	GM11	GM-CH11 VOL&EFF1	ON	END	-	-	-	-	-	-	-	-	-	-	-	-	-	-	-	
			ENCODER	BA	0C	ENC	END	-	-	-	-	-	-	-	-	-	-	-	-	-
			FADER	BA	07	FAD	END	-	-	-	-	-	-	-	-	-	-	-	-	-
RM12	GM12	GM-CH12 VOL&EFF1	ON	END	-	-	-	-	-	-	-	-	-	-	-	-	-	-	-	
			ENCODER	BB	0C	ENC	END	-	-	-	-	-	-	-	-	-	-	-	-	-
			FADER	BB	07	FAD	END	-	-	-	-	-	-	-	-	-	-	-	-	-
RM13	GM13	GM-CH13 VOL&EFF1	ON	END	-	-	-	-	-	-	-	-	-	-	-	-	-	-	-	
			ENCODER	BC	0C	ENC	END	-	-	-	-	-	-	-	-	-	-	-	-	-
			FADER	BC	07	FAD	END	-	-	-	-	-	-	-	-	-	-	-	-	-
RM14	GM14	GM-CH14 VOL&EFF1	ON	END	-	-	-	-	-	-	-	-	-	-	-	-	-	-	-	
			ENCODER	BD	0C	ENC	END	-	-	-	-	-	-	-	-	-	-	-	-	-
			FADER	BD	07	FAD	END	-	-	-	-	-	-	-	-	-	-	-	-	-
RM15	GM15	GM-CH15 VOL&EFF1	ON	END	-	-	-	-	-	-	-	-	-	-	-	-	-	-	-	
			ENCODER	BE	0C	ENC	END	-	-	-	-	-	-	-	-	-	-	-	-	-
			FADER	BE	07	FAD	END	-	-	-	-	-	-	-	-	-	-	-	-	-
RM16	GM16	GM-CH16 VOL&EFF1	ON	END	-	-	-	-	-	-	-	-	-	-	-	-	-	-	-	
			ENCODER	BF	0C	ENC	END	-	-	-	-	-	-	-	-	-	-	-	-	-
			FADER	BF	07	FAD	END	-	-	-	-	-	-	-	-	-	-	-	-	-



**Bank 3 (XG Vol & Pan)**

ID	Name		Controller	Data Format																
	Short	Long		1	2	3	4	5	6	7	8	9	10	11	12	13	14	15	16	
RM01	XG01	XG-CH01 VOL&PAN	ON	END	-	-	-	-	-	-	-	-	-	-	-	-	-	-	-	
			ENCODER	F0	43	10	4C	08	00	0E	ENC	F7	END	-	-	-	-	-	-	-
			FADER	F0	43	10	4C	08	00	0B	FAD	F7	END	-	-	-	-	-	-	-
RM02	XG02	XG-CH02 VOL&PAN	ON	END	-	-	-	-	-	-	-	-	-	-	-	-	-	-	-	
			ENCODER	F0	43	10	4C	08	01	0E	ENC	F7	END	-	-	-	-	-	-	-
			FADER	F0	43	10	4C	08	01	0B	FAD	F7	END	-	-	-	-	-	-	-
RM03	XG03	XG-CH03 VOL&PAN	ON	END	-	-	-	-	-	-	-	-	-	-	-	-	-	-	-	
			ENCODER	F0	43	10	4C	08	02	0E	ENC	F7	END	-	-	-	-	-	-	-
			FADER	F0	43	10	4C	08	02	0B	FAD	F7	END	-	-	-	-	-	-	-
RM04	XG04	XG-CH04 VOL&PAN	ON	END	-	-	-	-	-	-	-	-	-	-	-	-	-	-	-	
			ENCODER	F0	43	10	4C	08	03	0E	ENC	F7	END	-	-	-	-	-	-	-
			FADER	F0	43	10	4C	08	03	0B	FAD	F7	END	-	-	-	-	-	-	-
RM05	XG05	XG-CH05 VOL&PAN	ON	END	-	-	-	-	-	-	-	-	-	-	-	-	-	-	-	
			ENCODER	F0	43	10	4C	08	04	0E	ENC	F7	END	-	-	-	-	-	-	-
			FADER	F0	43	10	4C	08	04	0B	FAD	F7	END	-	-	-	-	-	-	-
RM06	XG06	XG-CH06 VOL&PAN	ON	END	-	-	-	-	-	-	-	-	-	-	-	-	-	-	-	
			ENCODER	F0	43	10	4C	08	05	0E	ENC	F7	END	-	-	-	-	-	-	-
			FADER	F0	43	10	4C	08	05	0B	FAD	F7	END	-	-	-	-	-	-	-
RM07	XG07	XG-CH07 VOL&PAN	ON	END	-	-	-	-	-	-	-	-	-	-	-	-	-	-	-	
			ENCODER	F0	43	10	4C	08	06	0E	ENC	F7	END	-	-	-	-	-	-	-
			FADER	F0	43	10	4C	08	06	0B	FAD	F7	END	-	-	-	-	-	-	-
RM08	XG08	XG-CH08 VOL&PAN	ON	END	-	-	-	-	-	-	-	-	-	-	-	-	-	-	-	
			ENCODER	F0	43	10	4C	08	07	0E	ENC	F7	END	-	-	-	-	-	-	-
			FADER	F0	43	10	4C	08	07	0B	FAD	F7	END	-	-	-	-	-	-	-
RM09	XG09	XG-CH09 VOL&PAN	ON	END	-	-	-	-	-	-	-	-	-	-	-	-	-	-	-	
			ENCODER	F0	43	10	4C	08	08	0E	ENC	F7	END	-	-	-	-	-	-	-
			FADER	F0	43	10	4C	08	08	0B	FAD	F7	END	-	-	-	-	-	-	-
RM10	XG10	XG-CH10 VOL&PAN	ON	END	-	-	-	-	-	-	-	-	-	-	-	-	-	-	-	
			ENCODER	F0	43	10	4C	08	09	0E	ENC	F7	END	-	-	-	-	-	-	-
			FADER	F0	43	10	4C	08	09	0B	FAD	F7	END	-	-	-	-	-	-	-
RM11	XG11	XG-CH11 VOL&PAN	ON	END	-	-	-	-	-	-	-	-	-	-	-	-	-	-	-	
			ENCODER	F0	43	10	4C	08	0A	0E	ENC	F7	END	-	-	-	-	-	-	-
			FADER	F0	43	10	4C	08	0A	0B	FAD	F7	END	-	-	-	-	-	-	-
RM12	XG12	XG-CH12 VOL&PAN	ON	END	-	-	-	-	-	-	-	-	-	-	-	-	-	-	-	
			ENCODER	F0	43	10	4C	08	0B	0E	ENC	F7	END	-	-	-	-	-	-	-
			FADER	F0	43	10	4C	08	0B	0B	FAD	F7	END	-	-	-	-	-	-	-
RM13	XG13	XG-CH13 VOL&PAN	ON	END	-	-	-	-	-	-	-	-	-	-	-	-	-	-	-	
			ENCODER	F0	43	10	4C	08	0C	0E	ENC	F7	END	-	-	-	-	-	-	-
			FADER	F0	43	10	4C	08	0C	0B	FAD	F7	END	-	-	-	-	-	-	-
RM14	XG14	XG-CH14 VOL&PAN	ON	END	-	-	-	-	-	-	-	-	-	-	-	-	-	-	-	
			ENCODER	F0	43	10	4C	08	0D	0E	ENC	F7	END	-	-	-	-	-	-	-
			FADER	F0	43	10	4C	08	0D	0B	FAD	F7	END	-	-	-	-	-	-	-
RM15	XG15	XG-CH15 VOL&PAN	ON	END	-	-	-	-	-	-	-	-	-	-	-	-	-	-	-	
			ENCODER	F0	43	10	4C	08	0E	0E	ENC	F7	END	-	-	-	-	-	-	-
			FADER	F0	43	10	4C	08	0E	0B	FAD	F7	END	-	-	-	-	-	-	-
RM16	XG16	XG-CH16 VOL&PAN	ON	END	-	-	-	-	-	-	-	-	-	-	-	-	-	-	-	
			ENCODER	F0	43	10	4C	08	0F	0E	ENC	F7	END	-	-	-	-	-	-	-
			FADER	F0	43	10	4C	08	0F	0B	FAD	F7	END	-	-	-	-	-	-	-

**Bank 4 (Nuendo VST Mixer)**

ID	Name		Controller	Data Format																
	Short	Long		1	2	3	4	5	6	7	8	9	10	11	12	13	14	15	16	
RM01	CH1	VST MIXER CH1	ON	B0	40	SW	END	-	-	-	-	-	-	-	-	-	-	-	-	
			ENCODER	B0	0A	ENC	END	-	-	-	-	-	-	-	-	-	-	-	-	-
			FADER	B0	07	FAD	END	-	-	-	-	-	-	-	-	-	-	-	-	-
RM02	CH2	VST MIXER CH2	ON	B1	40	SW	END	-	-	-	-	-	-	-	-	-	-	-	-	
			ENCODER	B1	0A	ENC	END	-	-	-	-	-	-	-	-	-	-	-	-	-
			FADER	B1	07	FAD	END	-	-	-	-	-	-	-	-	-	-	-	-	-
RM03	CH3	VST MIXER CH3	ON	B2	40	SW	END	-	-	-	-	-	-	-	-	-	-	-	-	
			ENCODER	B2	0A	ENC	END	-	-	-	-	-	-	-	-	-	-	-	-	-
			FADER	B2	07	FAD	END	-	-	-	-	-	-	-	-	-	-	-	-	-
RM04	CH4	VST MIXER CH4	ON	B3	40	SW	END	-	-	-	-	-	-	-	-	-	-	-	-	
			ENCODER	B3	0A	ENC	END	-	-	-	-	-	-	-	-	-	-	-	-	-
			FADER	B3	07	FAD	END	-	-	-	-	-	-	-	-	-	-	-	-	-
RM05	CH5	VST MIXER CH5	ON	B4	40	SW	END	-	-	-	-	-	-	-	-	-	-	-	-	
			ENCODER	B4	0A	ENC	END	-	-	-	-	-	-	-	-	-	-	-	-	-
			FADER	B4	07	FAD	END	-	-	-	-	-	-	-	-	-	-	-	-	-
RM06	CH6	VST MIXER CH6	ON	B5	40	SW	END	-	-	-	-	-	-	-	-	-	-	-	-	
			ENCODER	B5	0A	ENC	END	-	-	-	-	-	-	-	-	-	-	-	-	-
			FADER	B5	07	FAD	END	-	-	-	-	-	-	-	-	-	-	-	-	-
RM07	CH7	VST MIXER CH7	ON	B6	40	SW	END	-	-	-	-	-	-	-	-	-	-	-	-	
			ENCODER	B6	0A	ENC	END	-	-	-	-	-	-	-	-	-	-	-	-	-
			FADER	B6	07	FAD	END	-	-	-	-	-	-	-	-	-	-	-	-	-
RM08	CH8	VST MIXER CH8	ON	B7	40	SW	END	-	-	-	-	-	-	-	-	-	-	-	-	
			ENCODER	B7	0A	ENC	END	-	-	-	-	-	-	-	-	-	-	-	-	-
			FADER	B7	07	FAD	END	-	-	-	-	-	-	-	-	-	-	-	-	-
RM09	CH9	VST MIXER CH9	ON	B8	40	SW	END	-	-	-	-	-	-	-	-	-	-	-	-	
			ENCODER	B8	0A	ENC	END	-	-	-	-	-	-	-	-	-	-	-	-	-
			FADER	B8	07	FAD	END	-	-	-	-	-	-	-	-	-	-	-	-	-
RM10	CH10	VST MIXER CH10	ON	B9	40	SW	END	-	-	-	-	-	-	-	-	-	-	-	-	
			ENCODER	B9	0A	ENC	END	-	-	-	-	-	-	-	-	-	-	-	-	-
			FADER	B9	07	FAD	END	-	-	-	-	-	-	-	-	-	-	-	-	-
RM11	CH11	VST MIXER CH11	ON	BA	40	SW	END	-	-	-	-	-	-	-	-	-	-	-	-	
			ENCODER	BA	0A	ENC	END	-	-	-	-	-	-	-	-	-	-	-	-	-
			FADER	BA	07	FAD	END	-	-	-	-	-	-	-	-	-	-	-	-	-
RM12	CH12	VST MIXER CH12	ON	BB	40	SW	END	-	-	-	-	-	-	-	-	-	-	-	-	
			ENCODER	BB	0A	ENC	END	-	-	-	-	-	-	-	-	-	-	-	-	-
			FADER	BB	07	FAD	END	-	-	-	-	-	-	-	-	-	-	-	-	-
RM13	CH13	VST MIXER CH13	ON	BC	40	SW	END	-	-	-	-	-	-	-	-	-	-	-	-	
			ENCODER	BC	0A	ENC	END	-	-	-	-	-	-	-	-	-	-	-	-	-
			FADER	BC	07	FAD	END	-	-	-	-	-	-	-	-	-	-	-	-	-
RM14	CH14	VST MIXER CH14	ON	BD	40	SW	END	-	-	-	-	-	-	-	-	-	-	-	-	
			ENCODER	BD	0A	ENC	END	-	-	-	-	-	-	-	-	-	-	-	-	-
			FADER	BD	07	FAD	END	-	-	-	-	-	-	-	-	-	-	-	-	-
RM15	CH15	VST MIXER CH15	ON	BE	40	SW	END	-	-	-	-	-	-	-	-	-	-	-	-	
			ENCODER	BE	0A	ENC	END	-	-	-	-	-	-	-	-	-	-	-	-	-
			FADER	BE	07	FAD	END	-	-	-	-	-	-	-	-	-	-	-	-	-
RM16	CH16	VST MIXER CH16	ON	BF	40	SW	END	-	-	-	-	-	-	-	-	-	-	-	-	
			ENCODER	BF	0A	ENC	END	-	-	-	-	-	-	-	-	-	-	-	-	-
			FADER	BF	07	FAD	END	-	-	-	-	-	-	-	-	-	-	-	-	-

## Effects Parameters

### REVERB HALL, REVERB ROOM, REVERB STAGE, REVERB PLATE

One input, two output hall, room, stage, and plate reverb simulations, all with gates.

Parameter	Range	Description
REV TIME	0.3–99.0 s	Reverb time
INI. DLY	0.0–500.0 ms	Initial delay before reverb begins
HI. RATIO	0.1–1.0	High-frequency reverb time ratio
LO. RATIO	0.1–2.4	Low-frequency reverb time ratio
DIFF.	0–10	Reverb diffusion (left–right reverb spread)
DENSITY	0–100%	Reverb density
E/R DLY	0.0–100.0 ms	Delay between early reflections and reverb
E/R BAL.	0–100%	Balance of early reflections and reverb (0% = all reverb, 100% = all early reflections)
HPF	THRU, 21.2 Hz–8.00 kHz	High-pass filter cutoff frequency
LPF	50.0 Hz–16.0 kHz, THRU	Low-pass filter cutoff frequency
GATE LVL	OFF, –60 to 0 dB	Level at which gate kicks in
ATTACK	0–120 ms	Gate opening speed
HOLD	1	Gate open time
DECAY	2	Gate closing speed

- 0.02 ms–2.13 s (fs=44.1 kHz), 0.02 ms–1.96 s (fs=48 kHz), 0.01 ms–1.06 s (fs=88.2 kHz), 0.01 ms–981 ms (fs=96 kHz)
- 6 ms–46.0 s (fs=44.1 kHz), 5 ms–42.3 s (fs=48 kHz), 3 ms–23.0 s (fs=88.2 kHz), 3 ms–21.1 s (fs=96 kHz)

### EARLY REF.

One input, two output early reflections.

Parameter	Range	Description
TYPE	S-Hall, L-Hall, Random, Revers, Plate, Spring	Type of early reflection simulation
ROOMSIZE	0.1–20.0	Reflection spacing
LIVENESS	0–10	Early reflections decay characteristics (0 = dead, 10 = live)
INI. DLY	0.0–500.0 ms	Initial delay before reverb begins
DIFF.	0–10	Reflection diffusion (left–right reflection spread)
DENSITY	0–100%	Reflection density
ER NUM.	1–19	Number of early reflections
FB.GAIN	–99 to +99%	Feedback gain
HI. RATIO	0.1–1.0	High-frequency feedback ratio
HPF	THRU, 21.2 Hz–8.00 kHz	High-pass filter cutoff frequency
LPF	50.0 Hz–16.0 kHz, THRU	Low-pass filter cutoff frequency

## GATE REVERB, REVERSE GATE

One input, two output early reflections with gate, and early reflections with reverse gate.

Parameter	Range	Description
TYPE	Type-A, Type-B	Type of early reflection simulation
ROOMSIZE	0.1–20.0	Reflection spacing
LIVENESS	0–10	Early reflections decay characteristics (0 = dead, 10 = live)
INI. DLY	0.0–500.0 ms	Initial delay before reverb begins
DIFF.	0–10	Reflection diffusion (left–right reflection spread)
DENSITY	0–100%	Reflection density
HI. RATIO	0.1–1.0	High-frequency feedback ratio
ER NUM.	1–19	Number of early reflections
FB.GAIN	–99 to +99%	Feedback gain
HPF	THRU, 21.2 Hz–8.00 kHz	High-pass filter cutoff frequency
LPF	50.0 Hz–16.0 kHz, THRU	Low-pass filter cutoff frequency

## MONO DELAY

One input, two output basic repeat delay.

Parameter	Range	Description
DELAY	0.0–2730.0 ms	Delay time
FB. GAIN	–99 to +99%	Feedback gain (plus values for normal-phase feedback, minus values for reverse-phase feedback)
HI. RATIO	0.1–1.0	High-frequency feedback ratio
HPF	THRU, 21.2 Hz–8.00 kHz	High-pass filter cutoff frequency
LPF	50.0 Hz–16.0 kHz, THRU	Low-pass filter cutoff frequency
SYNC	OFF, ON	Tempo parameter sync on/off
NOTE	1	Used in conjunction with TEMPO to determine DELAY

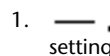
1.  (Max. value depends on tempo setting)

## STEREO DELAY

Two input, two output basic stereo delay.

Parameter	Range	Description
DELAY L	0.0–1350.0 ms	Left channel delay time
DELAY R	0.0–1350.0 ms	Right channel delay time
FB. G L	–99 to +99%	Left channel feedback (plus values for normal-phase feedback, minus values for reverse-phase feedback)
FB. G R	–99 to +99%	Right channel feedback (plus values for normal-phase feedback, minus values for reverse-phase feedback)
HI. RATIO	0.1–1.0	High-frequency feedback ratio
HPF	THRU, 21.2 Hz–8.00 kHz	High-pass filter cutoff frequency
LPF	50.0 Hz–16.0 kHz, THRU	Low-pass filter cutoff frequency
SYNC	OFF, ON	Tempo parameter sync on/off
NOTE L	1	Used in conjunction with TEMPO to determine left channel DELAY
NOTE R	1	Used in conjunction with TEMPO to determine right channel DELAY

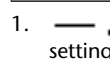
1.  (Maximum value depends on the tempo setting)

## MOD. DELAY

One input, two output basic repeat delay with modulation.

Parameter	Range	Description
DELAY	0.0–2725.0 ms	Delay time
FB. GAIN	–99 to +99%	Feedback gain (plus values for normal-phase feedback, minus values for reverse-phase feedback)
HI. RATIO	0.1–1.0	High-frequency feedback ratio
FREQ.	0.05–40.00 Hz	Modulation speed
DEPTH	0–100%	Modulation depth
WAVE	Sine, Tri	Modulation waveform
HPF	THRU, 21.2 Hz–8.00 kHz	High-pass filter cutoff frequency
LPF	50.0 Hz–16.0 kHz, THRU	Low-pass filter cutoff frequency
SYNC	OFF, ON	Tempo parameter sync on/off
DLY.NOTE	1	Used in conjunction with TEMPO to determine DELAY
MOD.NOTE	2	Used in conjunction with TEMPO to determine FREQ

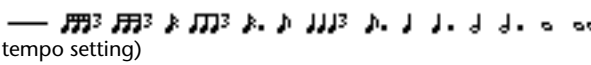
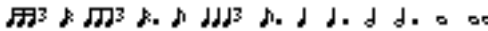
1.  (Maximum value depends on the tempo setting)
2. 

## DELAY LCR

One input, two output 3-tap delay (left, center, right).

Parameter	Range	Description
DELAY L	0.0–2730.0 ms	Left channel delay time
DELAY C	0.0–2730.0 ms	Center channel delay time
DELAY R	0.0–2730.0 ms	Right channel delay time
FB. DLY	0.0–2730.0 ms	Feedback delay time
LEVEL L	–100 to +100%	Left channel delay level
LEVEL C	–100 to +100%	Center channel delay level
LEVEL R	–100 to +100%	Right channel delay level
FB. GAIN	–99 to +99%	Feedback gain (plus values for normal-phase feedback, minus values for reverse-phase feedback)
HI. RATIO	0.1–1.0	High-frequency feedback ratio
HPF	THRU, 21.2 Hz–8.00 kHz	High-pass filter cutoff frequency
LPF	50.0 Hz–16.0 kHz, THRU	Low-pass filter cutoff frequency
SYNC	OFF, ON	Tempo parameter sync on/off
NOTE L	1	Used in conjunction with TEMPO to determine DELAY L
NOTE C	1	Used in conjunction with TEMPO to determine DELAY C
NOTE R	1	Used in conjunction with TEMPO to determine DELAY R
NOTE FB	1	Used in conjunction with TEMPO to determine FB. DLY

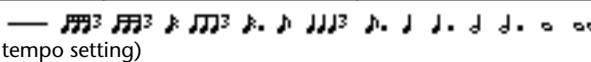
1.  (Maximum value depends on the tempo setting)

## ECHO

Two input, two output stereo delay with crossed feedback loop.

Parameter	Range	Description
DELAY L	0.0–1350.0 ms	Left channel delay time
DELAY R	0.0–1350.0 ms	Right channel delay time
FB.DLY L	0.0–1350.0 ms	Left channel feedback delay time
FB.DLY R	0.0–1350.0 ms	Right channel feedback delay time
FB. G L	–99 to +99%	Left channel feedback gain (plus values for normal-phase feedback, minus values for reverse-phase feedback)
FB. G R	–99 to +99%	Right channel feedback gain (plus values for normal-phase feedback, minus values for reverse-phase feedback)
L->R FBG	–99 to +99%	Left to right channel feedback gain (plus values for normal-phase feedback, minus values for reverse-phase feedback)
R->L FBG	–99 to +99%	Right to left channel feedback gain (plus values for normal-phase feedback, minus values for reverse-phase feedback)
HI. RATIO	0.1–1.0	High-frequency feedback ratio
HPF	THRU, 21.2 Hz–8.00 kHz	High-pass filter cutoff frequency
LPF	50.0 Hz–16.0 kHz, THRU	Low-pass filter cutoff frequency
SYNC	OFF, ON	Tempo parameter sync on/off
NOTE L	1	Used in conjunction with TEMPO to determine DELAY L
NOTE R	1	Used in conjunction with TEMPO to determine DELAY R
NOTE FBL	1	Used in conjunction with TEMPO to determine FB.DLY L
NOTE FBR	1	Used in conjunction with TEMPO to determine FB.DLY R

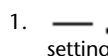
1.  (Maximum value depends on the tempo setting)

## CHORUS

Two input, two output chorus effect.

Parameter	Range	Description
FREQ.	0.05–40.00 Hz	Modulation speed
AM DEPTH	0–100%	Amplitude modulation depth
PM DEPTH	0–100%	Pitch modulation depth
MOD. DLY	0.0–500.0 ms	Modulation delay time
WAVE	Sine, Tri	Modulation waveform
LSH F	21.2 Hz–8.00 kHz	Low shelving filter frequency
LSH G	–12.0 to +12.0 dB	Low shelving filter gain
EQ F	100 Hz–8.00 kHz	EQ (peaking type) frequency
EQ G	–12.0 to +12.0 dB	EQ (peaking type) gain
EQ Q	10.0–0.10	EQ (peaking type) bandwidth
HSH F	50.0 Hz–16.0 kHz	High shelving filter frequency
HSH G	–12.0 to +12.0 dB	High shelving filter gain
SYNC	OFF, ON	Tempo parameter sync on/off
NOTE	1	Used in conjunction with TEMPO to determine FREQ.

1. 

## FLANGE

Two input, two output flange effect.

Parameter	Range	Description
FREQ.	0.05–40.00 Hz	Modulation speed
DEPTH	0–100%	Modulation depth
MOD. DLY	0.0–500.0 ms	Modulation delay time
FB. GAIN	–99 to +99%	Feedback gain (plus values for normal-phase feedback, minus values for reverse-phase feedback)
WAVE	Sine, Tri	Modulation waveform
LSH F	21.2 Hz–8.00 kHz	Low shelving filter frequency
LSH G	–12.0 to +12.0 dB	Low shelving filter gain
EQ F	100 Hz–8.00 kHz	EQ (peaking type) frequency
EQ G	–12.0 to +12.0 dB	EQ (peaking type) gain
EQ Q	10.0–0.10	EQ (peaking type) bandwidth
HSH F	50.0 Hz–16.0 kHz	High shelving filter frequency
HSH G	–12.0 to +12.0 dB	High shelving filter gain
SYNC	OFF, ON	Tempo parameter sync on/off
NOTE	<sup>1</sup>	Used in conjunction with TEMPO to determine FREQ.

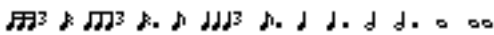
1. 

## SYMPHONIC

Two input, two output symphonic effect.

Parameter	Range	Description
FREQ.	0.05–40.00 Hz	Modulation speed
DEPTH	0–100%	Modulation depth
MOD. DLY	0.0–500.0 ms	Modulation delay time
WAVE	Sine, Tri	Modulation waveform
LSH F	21.2 Hz–8.00 kHz	Low shelving filter frequency
LSH G	–12.0 to +12.0 dB	Low shelving filter gain
EQ F	100 Hz–8.00 kHz	EQ (peaking type) frequency
EQ G	–12.0 to +12.0 dB	EQ (peaking type) gain
EQ Q	10.0–0.10	EQ (peaking type) bandwidth
HSH F	50.0 Hz–16.0 kHz	High shelving filter frequency
HSH G	–12.0 to +12.0 dB	High shelving filter gain
SYNC	OFF, ON	Tempo parameter sync on/off
NOTE	<sup>1</sup>	Used in conjunction with TEMPO to determine FREQ.

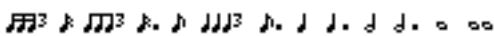
1. 

## PHASER

Two input, two output 16-stage phaser.

Parameter	Range	Description
FREQ.	0.05–40.00 Hz	Modulation speed
DEPTH	0–100%	Modulation depth
FB. GAIN	–99 to +99%	Feedback gain (plus values for normal-phase feedback, minus values for reverse-phase feedback)
OFFSET	0–100	Lowest phase-shifted frequency offset
PHASE	0.00–354.38 degrees	Left and right modulation phase balance
STAGE	2, 4, 6, 8, 10, 12, 14, 16	Number of phase shift stages
LSH F	21.2 Hz–8.00 kHz	Low shelving filter frequency
LSH G	–12.0 to +12.0 dB	Low shelving filter gain
HSH F	50.0 Hz–16.0 kHz	High shelving filter frequency
HSH G	–12.0 to +12.0 dB	High shelving filter gain
SYNC	OFF, ON	Tempo parameter sync on/off
NOTE	1	Used in conjunction with TEMPO to determine FREQ.

1. 

## AUTO PAN

Two input, two output autopanner.

Parameter	Range	Description
FREQ.	0.05–40.00 Hz	Modulation speed
DEPTH	0–100%	Modulation depth
DIR.	1	Panning direction
WAVE	Sine, Tri, Square	Modulation waveform
LSH F	21.2 Hz–8.00 kHz	Low shelving filter frequency
LSH G	–12.0 to +12.0 dB	Low shelving filter gain
EQ F	100 Hz–8.00 kHz	EQ (peaking type) frequency
EQ G	–12.0 to +12.0 dB	EQ (peaking type) gain
EQ Q	10.0–0.10	EQ (peaking type) bandwidth
HSH F	50.0 Hz–16.0 kHz	High shelving filter frequency
HSH G	–12.0 to +12.0 dB	High shelving filter gain
SYNC	OFF, ON	Tempo parameter sync on/off
NOTE	2	Used in conjunction with TEMPO to determine FREQ.

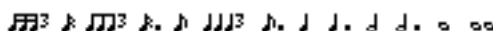
1. L<->R, L->R, L<-R, Turn L, Turn R
2. 



## TREMOLO

Two input, two output tremolo effect.

Parameter	Range	Description
FREQ.	0.05–40.00 Hz	Modulation speed
DEPTH	0–100%	Modulation depth
WAVE	Sine, Tri, Square	Modulation waveform
LSH F	21.2 Hz–8.00 kHz	Low shelving filter frequency
LSH G	–12.0 to +12.0 dB	Low shelving filter gain
EQ F	100 Hz–8.00 kHz	EQ (peaking type) frequency
EQ G	–12.0 to +12.0 dB	EQ (peaking type) gain
EQ Q	10.0–0.10	EQ (peaking type) bandwidth
HSH F	50.0 Hz–16.0 kHz	High shelving filter frequency
HSH G	–12.0 to +12.0 dB	High shelving filter gain
SYNC	OFF, ON	Tempo parameter sync on/off
NOTE	<sup>1</sup>	Used in conjunction with TEMPO to determine FREQ.

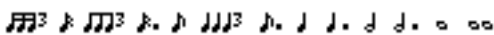
1. 

## HQ. PITCH

One input, two output high-quality pitch shifter.

Parameter	Range	Description
PITCH	–12 to +12 semitones	Pitch shift
FINE	–50 to +50 cents	Pitch shift fine
DELAY	0.0–1000.0 ms	Delay time
FB. GAIN	–99 to +99%	Feedback gain (plus values for normal-phase feedback, minus values for reverse-phase feedback)
MODE	1–10	Pitch shift precision
SYNC	OFF, ON	Tempo parameter sync on/off
NOTE	<sup>1</sup>	Used in conjunction with TEMPO to determine DELAY

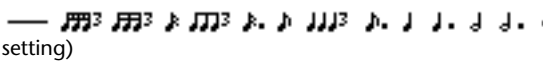
1.  (Maximum value depends on the tempo setting)

## DUAL PITCH

Two input, two output pitch shifter.

Parameter	Range	Description
PITCH 1	-24 to +24 semitones	Channel #1 pitch shift
FINE 1	-50 to +50 cents	Channel #1 pitch shift fine
LEVEL 1	-100 to +100%	Channel #1 level (plus values for normal phase, minus values for reverse phase)
PAN 1	L63 to R63	Channel #1 pan
DELAY 1	0.0-1000.0 ms	Channel #1 delay time
FB. G 1	-99 to +99%	Channel #1 feedback gain (plus values for normal-phase feedback, minus values for reverse-phase feedback)
PITCH 2	-24 to +24 semitones	Channel #2 pitch shift
FINE 2	-50 to +50 cents	Channel #2 pitch shift fine
LEVEL 2	-100 to +100%	Channel #2 level (plus values for normal phase, minus values for reverse phase)
PAN 2	L63 to R63	Channel #2 pan
DELAY 2	0.0-1000.0 ms	Channel #2 delay time
FB. G 2	-99 to +99%	Channel #2 feedback gain (plus values for normal-phase feedback, minus values for reverse-phase feedback)
MODE	1-10	Pitch shift precision
SYNC	OFF, ON	Tempo parameter sync on/off
NOTE 1	1	Used in conjunction with TEMPO to determine Channel #1 delay
NOTE 2	1	Used in conjunction with TEMPO to determine Channel #2 delay

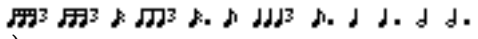
1.  (Maximum value depends on the tempo setting)

## ROTARY

One input, two output rotary speaker simulator.

Parameter	Range	Description
ROTATE	STOP, START	Rotation stop, start
SPEED	SLOW, FAST	Rotation speed (see SLOW and FAST parameters)
SLOW	0.05-10.00 Hz	SLOW rotation speed
FAST	0.05-10.00 Hz	FAST rotation speed
DRIVE	0-100	Overdrive level
ACCEL	0-10	Acceleration at speed changes
LOW	0-100	Low-frequency filter
HIGH	0-100	High-frequency filter

## RING MOD.

Two input, two output ring modulator.

Parameter	Range	Description
SOURCE	OSC, SELF	Modulation source: oscillator or input signal
OSC FREQ	0.0–5000.0 Hz	Oscillator frequency
FM FREQ.	0.05–40.00 Hz	Oscillator frequency modulation speed
FM DEPTH	0–100%	Oscillator frequency modulation depth
SYNC	OFF, ON	Tempo parameter sync on/off
NOTE FM	<sup>1</sup>	Used in conjunction with TEMPO to determine FM FREQ

1. 

## MOD. FILTER

Two input, two output modulation filter.

Parameter	Range	Description
FREQ.	0.05–40.00 Hz	Modulation speed
DEPTH	0–100%	Modulation depth
PHASE	0.00–354.38 degrees	Left-channel modulation and right-channel modulation phase difference
TYPE	LPF, HPF, BPF	Filter type: low pass, high pass, band pass
OFFSET	0–100	Filter frequency offset
RESO.	0–20	Filter resonance
LEVEL	0–100	Output level
SYNC	OFF, ON	Tempo parameter sync on/off
NOTE	<sup>1</sup>	Used in conjunction with TEMPO to determine FREQ

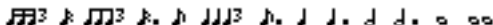
1. 

## DISTORTION

One input, two output distortion effect.

Parameter	Range	Description
DST TYPE	DST1, DST2, OVD1, OVD2, CRUNCH	Distortion type (DST = distortion, OVD = overdrive)
DRIVE	0–100	Distortion drive
MASTER	0–100	Master volume
STONE	–10 to +10	Tone
N. GATE	0–20	Noise reduction

**AMP SIMULATE**

One input, two output guitar amp simulator.

Parameter	Range	Description
AMP TYPE	1	Guitar amp simulation type
DST TYPE	DST1, DST2, OVD1, OVD2, CRUNCH	Distortion type (DST = distortion, OVD = overdrive)
DRIVE	0–100	Distortion drive
MASTER	0–100	Master volume
BASS	0–100	Bass tone control
MIDDLE	0–100	Middle tone control
TREBLE	0–100	High tone control
CAB DEP	0–100%	Speaker cabinet simulation depth
EQ F	100–8.00 kHz	Parametric equalizer frequency
EQ G	–12.0 to +12.0 dB	Parametric equalizer gain
EQ Q	10.0–0.10	Parametric equalizer bandwidth
N. GATE	0–20	Noise reduction

1. STK-M1, STK-M2, THRASH, MIDBST, CMB-PG, CMB-VR, CMB-DX, CMB-TW, MINI, FLAT

**DYNA. FILTER**

Two input, two output dynamically controlled filter.

Parameter	Range	Description
SOURCE	INPUT, MIDI	Control source: input signal or MIDI Note On velocity
SENSE	0–100	Sensitivity
DIR.	UP, DOWN	Upward or downward frequency change
DECAY	1	Filter frequency change decay speed
TYPE	LPF, HPF, BPF	Filter type
OFFSET	0–100	Filter frequency offset
RESO.	0–20	Filter resonance
LEVEL	0–100	Output Level

1. 6 ms–46.0 s ( $f_s=44.1$  kHz), 5 ms–42.3 s ( $f_s=48$  kHz), 3 ms–23.0 s ( $f_s=88.2$  kHz), 3 ms–21.1 s ( $f_s=96$  kHz)

**DYNA. FLANGE**

Two input, two output dynamically controlled flanger.

Parameter	Range	Description
<b>SOURCE</b>	INPUT, MIDI	Control source: input signal or MIDI Note On velocity
<b>SENSE</b>	0–100	Sensitivity
<b>DIR.</b>	UP, DOWN	Upward or downward frequency change
<b>DECAY</b>	1	Decay speed
<b>OFFSET</b>	0–100	Delay time offset
<b>FB.GAIN</b>	–99 to +99%	Feedback gain (plus values for normal-phase feedback, minus values for reverse-phase feedback)
<b>LSH F</b>	21.2 Hz–8.00 kHz	Low shelving filter frequency
<b>LSH G</b>	–12.0 to +12.0 dB	Low shelving filter gain
<b>EQ F</b>	100 Hz–8.00 kHz	EQ (peaking type) frequency
<b>EQ G</b>	–12.0 to +12.0 dB	EQ (peaking type) gain
<b>EQ Q</b>	10.0–0.10	EQ (peaking type) bandwidth
<b>HSH F</b>	50.0 Hz–16.0 kHz	High shelving filter frequency
<b>HSH G</b>	–12.0 to +12.0 dB	High shelving filter gain

1. 6 ms–46.0 s (fs=44.1 kHz), 5 ms–42.3 s (fs=48 kHz), 3 ms–23.0 s (fs=88.2 kHz), 3 ms–21.1 s (fs=96 kHz)

**DYNA. PHASER**

Two input, two output dynamically controlled phaser.

Parameter	Range	Description
<b>SOURCE</b>	INPUT, MIDI	Control source: input signal or MIDI Note On velocity
<b>SENSE</b>	0–100	Sensitivity
<b>DIR.</b>	UP, DOWN	Upward or downward frequency change
<b>DECAY</b>	1	Decay speed
<b>OFFSET</b>	0–100	Lowest phase-shifted frequency offset
<b>FB.GAIN</b>	–99 to +99%	Feedback gain (plus values for normal-phase feedback, minus values for reverse-phase feedback)
<b>STAGE</b>	2, 4, 6, 8, 10, 12, 14, 16	Number of phase shift stages
<b>LSH F</b>	21.2 Hz–8.00 kHz	Low shelving filter frequency
<b>LSH G</b>	–12.0 to +12.0 dB	Low shelving filter gain
<b>HSH F</b>	50.0 Hz–16.0 kHz	High shelving filter frequency
<b>HSH G</b>	–12.0 to +12.0 dB	High shelving filter gain

1. 6 ms–46.0 s (fs=44.1 kHz), 5 ms–42.3 s (fs=48 kHz), 3 ms–23.0 s (fs=88.2 kHz), 3 ms–21.1 s (fs=96 kHz)

**REV+CHORUS**

One input, two output reverb and chorus effects in parallel.

Parameter	Range	Description
REV TIME	0.3–99.0 s	Reverb time
INI. DLY	0.0–500.0 ms	Initial delay before reverb begins
HI. RATIO	0.1–1.0	High-frequency reverb time ratio
DIFF.	0–10	Spread
DENSITY	0–100%	Reverb density
HPF	THRU, 21.2 Hz–8.00 kHz	High-pass filter cutoff frequency
LPF	50.0 Hz–16.0 kHz, THRU	Low-pass filter cutoff frequency
REV/CHO	0–100%	Reverb and chorus balance (0% = all reverb, 100% = all chorus)
FREQ.	0.05–40.00 Hz	Modulation speed
AM DEPTH	0–100%	Amplitude modulation depth
PM DEPTH	0–100%	Pitch modulation depth
MOD. DLY	0.0–500.0 ms	Modulation delay time
WAVE	Sine, Tri	Modulation waveform
SYNC	OFF, ON	Tempo parameter sync on/off
NOTE	1	Used in conjunction with TEMPO to determine FREQ.

1. 

**REV->CHORUS**

One input, two output reverb and chorus effects in series.

Parameter	Range	Description
REV TIME	0.3–99.0 s	Reverb time
INI. DLY	0.0–500.0 ms	Initial delay before reverb begins
HI. RATIO	0.1–1.0	High-frequency reverb time ratio
DIFF.	0–10	Spread
DENSITY	0–100%	Reverb density
HPF	THRU, 21.2 Hz–8.00 kHz	High-pass filter cutoff frequency
LPF	50.0 Hz–16.0 kHz, THRU	Low-pass filter cutoff frequency
REV.BAL	0–100%	Reverb and chorused reverb balance (0% = all chorused reverb, 100% = all reverb)
FREQ.	0.05–40.00 Hz	Modulation speed
AM DEPTH	0–100%	Amplitude modulation depth
PM DEPTH	0–100%	Pitch modulation depth
MOD. DLY	0.0–500.0 ms	Modulation delay time
WAVE	Sine, Tri	Modulation waveform
SYNC	OFF, ON	Tempo parameter sync on/off
NOTE	1	Used in conjunction with TEMPO to determine FREQ.

1. 

**REV+FLANGE**

One input, two output reverb and flanger effects in parallel.

Parameter	Range	Description
REV TIME	0.3–99.0 s	Reverb time
INI. DLY	0.0–500.0 ms	Initial delay before reverb begins
HI. RATIO	0.1–1.0	High-frequency reverb time ratio
DIFF.	0–10	Spread
DENSITY	0–100%	Reverb density
HPF	THRU, 21.2 Hz–8.00 kHz	High-pass filter cutoff frequency
LPF	50.0 Hz–16.0 kHz, THRU	Low-pass filter cutoff frequency
REV/FLG	0–100%	Reverb and flange balance (0% = all reverb, 100% = all flange)
FREQ.	0.05–40.00 Hz	Modulation speed
DEPTH	0–100%	Modulation depth
MOD. DLY	0.0–500.0 ms	Modulation delay time
FB. GAIN	–99 to +99%	Feedback gain (plus values for normal-phase feedback, minus values for reverse-phase feedback)
WAVE	Sine, Tri	Modulation waveform
SYNC	OFF, ON	Tempo parameter sync on/off
NOTE	<sup>1</sup>	Used in conjunction with TEMPO to determine FREQ.

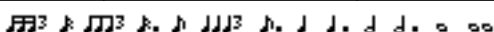
1. 

**REV->FLANGE**

One input, two output reverb and flanger effects in series.

Parameter	Range	Description
REV TIME	0.3–99.0 s	Reverb time
INI. DLY	0.0–500.0 ms	Initial delay before reverb begins
HI. RATIO	0.1–1.0	High-frequency reverb time ratio
DIFF.	0–10	Spread
DENSITY	0–100%	Reverb density
HPF	THRU, 21.2 Hz–8.00 kHz	High-pass filter cutoff frequency
LPF	50.0 Hz–16.0 kHz, THRU	Low-pass filter cutoff frequency
REV.BAL	0–100%	Reverb and flanged reverb balance (0% = all flanged reverb, 100% = all reverb)
FREQ.	0.05–40.00 Hz	Modulation speed
DEPTH	0–100%	Modulation depth
MOD. DLY	0.0–500.0 ms	Modulation delay time
FB. GAIN	–99 to +99%	Feedback gain (plus values for normal-phase feedback, minus values for reverse-phase feedback)
WAVE	Sine, Tri	Modulation waveform
SYNC	OFF, ON	Tempo parameter sync on/off
NOTE	<sup>1</sup>	Used in conjunction with TEMPO to determine FREQ.

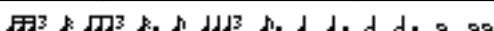
1. 

**REV+SYMPHO.**

One input, two output reverb and symphonic effects in parallel.

Parameter	Range	Description
REV TIME	0.3–99.0 s	Reverb time
INI. DLY	0.0–500.0 ms	Initial delay before reverb begins
HI. RATIO	0.1–1.0	High-frequency reverb time ratio
DIFF.	0–10	Spread
DENSITY	0–100%	Reverb density
HPF	THRU, 21.2 Hz–8.00 kHz	High-pass filter cutoff frequency
LPF	50.0 Hz–16.0 kHz, THRU	Low-pass filter cutoff frequency
REV/SYM	0–100%	Reverb and symphonic balance (0% = all reverb, 100% = all symphonic)
FREQ.	0.05–40.00 Hz	Modulation speed
DEPTH	0–100%	Modulation depth
MOD. DLY	0.0–500.0 ms	Modulation delay time
WAVE	Sine, Tri	Modulation waveform
SYNC	OFF, ON	Tempo parameter sync on/off
NOTE	<sup>1</sup>	Used in conjunction with TEMPO to determine FREQ.

1. 

**REV->SYMPHO.**

One input, two output reverb and symphonic effects in series.

Parameter	Range	Description
REV TIME	0.3–99.0 s	Reverb time
INI. DLY	0.0–500.0 ms	Initial delay before reverb begins
HI. RATIO	0.1–1.0	High-frequency reverb time ratio
DIFF.	0–10	Spread
DENSITY	0–100%	Reverb density
HPF	THRU, 21.2 Hz–8.00 kHz	High-pass filter cutoff frequency
LPF	50.0 Hz–16.0 kHz, THRU	Low-pass filter cutoff frequency
REV.BAL	0–100%	Reverb and symphonic reverb balance (0% = all symphonic reverb, 100% = all reverb)
FREQ.	0.05–40.00 Hz	Modulation speed
DEPTH	0–100%	Modulation depth
MOD. DLY	0.0–500.0 ms	Modulation delay time
WAVE	Sine, Tri	Modulation waveform
SYNC	OFF, ON	Tempo parameter sync on/off
NOTE	<sup>1</sup>	Used in conjunction with TEMPO to determine FREQ.

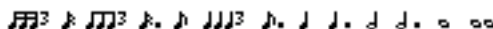
1. 



**REV->PAN**

One input, two output reverb and autopan effects in parallel.

Parameter	Range	Description
REV TIME	0.3–99.0 s	Reverb time
INI. DLY	0.0–500.0 ms	Initial delay before reverb begins
HI. RATIO	0.1–1.0	High-frequency reverb time ratio
DIFF.	0–10	Spread
DENSITY	0–100%	Reverb density
HPF	THRU, 21.2 Hz–8.00 kHz	High-pass filter cutoff frequency
LPF	50.0 Hz–16.0 kHz, THRU	Low-pass filter cutoff frequency
REV.BAL	0–100%	Reverb and panned reverb balance (0% = all panned reverb, 100% = all reverb)
FREQ.	0.05–40.00 Hz	Modulation speed
DEPTH	0–100%	Modulation depth
DIR.	1	Panning direction
WAVE	Sine, Tri, Square	Modulation waveform
SYNC	OFF, ON	Tempo parameter sync on/off
NOTE	2	Used in conjunction with TEMPO to determine FREQ.

1. L<->R, L->R, L<-R, Turn L, Turn R

2. 

**DELAY+ER.**

One input, two output delay and early reflections effects in parallel.

Parameter	Range	Description
DELAY L	0.0–1000.0 ms	Left channel delay time
DELAY R	0.0–1000.0 ms	Right channel delay time
FB. DLY	0.0–1000.0 ms	Feedback delay time
FB. GAIN	–99 to +99%	Feedback gain (plus values for normal-phase feedback, minus values for reverse-phase feedback)
HI. RATIO	0.1–1.0	High-frequency feedback ratio
HPF	THRU, 21.2 Hz–8.00 kHz	High-pass filter cutoff frequency
LPF	50.0 Hz–16.0 kHz, THRU	Low-pass filter cutoff frequency
DLY/ER	0–100%	Delay and early reflections balance (0% = all delay, 100% = all early reflections)
TYPE	S-Hall, L-Hall, Random, Revers, Plate, Spring	Type of early reflection simulation
ROOMSIZE	0.1–20.0	Reflection spacing
LIVENESS	0–10	Early reflections decay characteristics (0 = dead, 10 = live)
INI. DLY	0.0–500.0 ms	Initial delay before reverb begins
DIFF.	0–10	Spread
DENSITY	0–100%	Reverb density
ER NUM.	1–19	Number of early reflections
SYNC	OFF, ON	Tempo parameter sync on/off
NOTE L	1	Used in conjunction with TEMPO to determine left channel DELAY L
NOTE R	1	Used in conjunction with TEMPO to determine right channel DELAY R
NOTE FB	1	Used in conjunction with TEMPO to determine FB. DLY

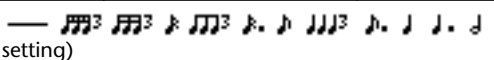
1.  (Maximum value depends on the tempo setting)

**DELAY->ER.**

One input, two output delay and early reflections effects in series.

Parameter	Range	Description
<b>DELAY L</b>	0.0–1000.0 ms	Left channel delay time
<b>DELAY R</b>	0.0–1000.0 ms	Right channel delay time
<b>FB. DLY</b>	0.0–1000.0 ms	Feedback delay time
<b>FB. GAIN</b>	–99 to +99%	Feedback gain (plus values for normal-phase feedback, minus values for reverse-phase feedback)
<b>HI. RATIO</b>	0.1–1.0	High-frequency feedback ratio
<b>HPF</b>	THRU, 21.2 Hz–8.00 kHz	High-pass filter cutoff frequency
<b>LPF</b>	50.0 Hz–16.0 kHz, THRU	Low-pass filter cutoff frequency
<b>DLY.BAL</b>	0–100%	Delay and early reflected delay balance (0% = all early reflected delay, 100% = all delay)
<b>TYPE</b>	S-Hall, L-Hall, Random, Revers, Plate, Spring	Type of early reflection simulation
<b>ROOMSIZE</b>	0.1–20.0	Reflection spacing
<b>LIVENESS</b>	0–10	Early reflections decay characteristics (0 = dead, 10 = live)
<b>INI. DLY</b>	0.0–500.0 ms	Initial delay before reverb begins
<b>DIFF.</b>	0–10	Spread
<b>DENSITY</b>	0–100%	Reverb density
<b>ER NUM.</b>	1–19	Number of early reflections
<b>SYNC</b>	OFF, ON	Tempo parameter sync on/off
<b>NOTE L</b>	1	Used in conjunction with TEMPO to determine left channel DELAY L
<b>NOTE R</b>	1	Used in conjunction with TEMPO to determine right channel DELAY R
<b>NOTE FB</b>	1	Used in conjunction with TEMPO to determine FB. DLY

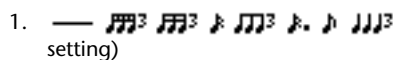
1.  (Maximum value depends on the tempo setting)

**DELAY+REV**

One input, two output delay and reverb effects in parallel.

Parameter	Range	Description
DELAY L	0.0–1000.0 ms	Left channel delay time
DELAY R	0.0–1000.0 ms	Right channel delay time
FB. DLY	0.0–1000.0 ms	Feedback delay time
FB. GAIN	–99 to +99%	Feedback gain (plus values for normal-phase feedback, minus values for reverse-phase feedback)
DELAY HI	0.1–1.0	Delay high-frequency feedback ratio
HPF	THRU, 21.2 Hz–8.00 kHz	High-pass filter cutoff frequency
LPF	50.0 Hz–16.0 kHz, THRU	Low-pass filter cutoff frequency
DLY.BAL	0–100%	Delay and reverb balance (0% = all delay, 100% = all reverb)
REV TIME	0.3–99.0 s	Reverb time
INI. DLY	0.0–500.0 ms	Initial delay before reverb begins
REV HI	0.1–1.0	High-frequency reverb time ratio
DIFF.	0–10	Spread
DENSITY	0–100%	Reverb density
SYNC	OFF, ON	Tempo parameter sync on/off
NOTE L	1	Used in conjunction with TEMPO to determine left channel DELAY L
NOTE R	1	Used in conjunction with TEMPO to determine right channel DELAY R
NOTE FB	1	Used in conjunction with TEMPO to determine FB. DLY

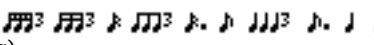
1.  (Maximum value depends on the tempo setting)

**DELAY->REV**

One input, two output delay and reverb effects in series.



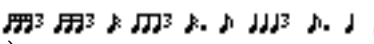



















Parameter	Range	Description
DELAY L	0.0–1000.0 ms	Left channel delay time
DELAY R	0.0–1000.0 ms	Right channel delay time
FB. DLY	0.0–1000.0 ms	Feedback delay time
FB. GAIN	–99 to +99%	Feedback gain (plus values for normal-phase feedback, minus values for reverse-phase feedback)
DELAY HI	0.1–1.0	Delay high-frequency feedback ratio
HPF	THRU, 21.2 Hz–8.00 kHz	High-pass filter cutoff frequency
LPF	50.0 Hz–16.0 kHz, THRU	Low-pass filter cutoff frequency
DLY.BAL	0–100%	Delay and delayed reverb balance (0% = all delayed reverb, 100% = all delay)
REV TIME	0.3–99.0 s	Reverb time
INI. DLY	0.0–500.0 ms	Initial delay before reverb begins
REV HI	0.1–1.0	High-frequency reverb time ratio
DIFF.	0–10	Spread
DENSITY	0–100%	Reverb density
SYNC	OFF, ON	Tempo parameter sync on/off
NOTE L	1	Used in conjunction with TEMPO to determine left channel DELAY L
NOTE R	*1	Used in conjunction with TEMPO to determine right channel DELAY R
NOTE FB	*1	Used in conjunction with TEMPO to determine FB. DLY

1.  (Maximum value depends on the tempo setting)

### DIST->DELAY

One input, two output distortion and delay effects in series.

Parameter	Range	Description
DST TYPE	DST1, DST2, OVD1, OVD2, CRUNCH	Distortion type (DST = distortion, OVD = overdrive)
DRIVE	0–100	Distortion drive
MASTER	0–100	Master volume
TONE	–10 to +10	Tone control
N. GATE	0–20	Noise reduction
DELAY	0.0–2725.0 ms	Delay time
FB. GAIN	–99 to +99%	Feedback gain (plus values for normal-phase feedback, minus values for reverse-phase feedback)
HI. RATIO	0.1–1.0	High-frequency feedback ratio
FREQ.	0.05–40.00 Hz	Modulation speed
DEPTH	0–100%	Modulation depth
DLY.BAL	0–100%	Distortion and delay balance (0% = all distortion, 100% = all delayed distortion)
SYNC	OFF, ON	Tempo parameter sync on/off
DLY.NOTE	1	Used in conjunction with TEMPO to determine DELAY
MOD.NOTE	2	Used in conjunction with TEMPO to determine FREQ.

1.            (Maximum value depends on the tempo setting)
2.            

### MULTI FILTER

Two input, two output 3-band multi-filter (24 dB/octave).

Parameter	Range	Description
TYPE 1	HPF, LPF, BPF	Filter 1 type: high pass, low pass, band pass
TYPE 2	HPF, LPF, BPF	Filter 2 type: high pass, low pass, band pass
TYPE 3	HPF, LPF, BPF	Filter 3 type: high pass, low pass, band pass
FREQ. 1	28.0 Hz–16.0 kHz	Filter 1 frequency
FREQ. 2	28.0 Hz–16.0 kHz	Filter 2 frequency
FREQ. 3	28.0 Hz–16.0 kHz	Filter 3 frequency
LEVEL 1	0–100	Filter 1 level
LEVEL 2	0–100	Filter 2 level
LEVEL 3	0–100	Filter 3 level
RESO. 1	0–20	Filter 1 resonance
RESO. 2	0–20	Filter 2 resonance
RESO. 3	0–20	Filter 3 resonance

## FREEZE

One input, one output basic sampler.

Parameter	Range	Description
REC MODE	MANUAL, INPUT	In MANUAL mode, recording is started by pressing the REC and PLAY buttons. In INPUT mode, Record-Ready mode is engaged by pressing the REC button, and actual recording is triggered by the input signal.
REC DLY	-1000 to +1000 ms	Recording delay. For plus values, recording starts after the trigger is received. For minus values, recording starts before the trigger is received.
TRG LVL	-60 to 0 dB	Input trigger level (i.e., the signal level required to trigger recording or playback)
TRG MASK	0-1000 ms	Once playback has been triggered, subsequent triggers are ignored for the duration of the TRG MASK time.
PLY MODE	MOMENT, CONTI., INPUT	In MOMENT mode, the sample plays only while the that the PLAY button is pressed. In CONT mode, playback continues once the PLAY button has been pressed. The number of times the sample plays is set using the LOOP NUM parameter. In INPUT mode, playback is triggered by the input signal.
START	1	Playback start point in milliseconds
END	1	Playback end point in milliseconds
LOOP	1	Loop start point in milliseconds
LOOP NUM	0-100	Number of times the sample plays
START [SAMPLE]	0-262000	Playback start point in samples
END [SAMPLE]	0-262000	Playback end point in samples
LOOP [SAMPLE]	0-262000	Loop start point in samples
PITCH	-12 to +12 semitones	Playback pitch shift
FINE	-50 to +50 cents	Playback pitch shift fine
MIDI TRG	OFF, C1-C6, ALL	PLAY button can be triggered by using MIDI Note on/off messages.

1. 0.0-5941.0 ms (fs=44.1 kHz), 0.0 ms-5458.3 ms (fs=48 kHz), 0.0-2970.5 ms (fs=88.2 kHz), 0.0 ms-2729.2 ms (fs=96 kHz)

## ST REVERB

Two input, two output stereo reverb.

Parameter	Range	Description
REV TIME	0.3-99.0 s	Reverb time
REV TYPE	Hall, Room, Stage, Plate	Reverb type
INI. DLY	0.0-100.0 ms	Initial delay before reverb begins
HI. RATIO	0.1-1.0	High-frequency reverb time ratio
LO. RATIO	0.1-2.4	Low-frequency reverb time ratio
DIFF.	0-10	Reverb diffusion (left-right reverb spread)
DENSITY	0-100%	Reverb density
E/R BAL.	0-100%	Balance of early reflections and reverb (0% = all reverb, 100% = all early reflections)
HPF	THRU, 21.2 Hz-8.00 kHz	High-pass filter cutoff frequency
LPF	50.0 Hz-16.0 kHz, THRU	Low-pass filter cutoff frequency

## REVERB 5.1

One input, six output reverb for 5.1 surround, with surround panning.

Parameter	Range	Description
REV TIME	0.3–99.0 s	Reverb time
REV TYPE	Hall, Room, Stage, Plate	Reverb type
HI. RATIO	0.1–1.0	High-frequency reverb time ratio
DIFF.	0–10	Reverb diffusion (left–right reverb spread)
DENSITY	0–100%	Reverb density
HPF	THRU, 21.2 Hz–8.00 kHz	High-pass filter cutoff frequency
LPF	50.0 Hz–16.0 kHz, THRU	Low-pass filter cutoff frequency
DIV.	0–100%	Divergence determines how the front center signal is fed to the Left, Right, and Center channels. When set to 0%, it's fed only to the Left and Right channels (i.e., Phantom Center). When set to 50%, it's fed equally to the Left, Right, and Center channels. When set to 100%, it's fed to only the Center channel (i.e., Real Center).
ROOMSIZE	0.1–20.0	Size of simulated room's reverb
POS L/R	L63–R63	Left/right listening position
POS F/R	F63–R63	Front/rear listening position
POS CTRL	OFF, NOR, INV	1
ER L/R	L63–R63	Left/right early reflections position
ER F/R	F63–R63	Front/rear early reflections position
ER LVL	0–100%	Early reflections level
ER CTRL	OFF, NOR, INV	1
REV L/R	L63–R63	Left/right reverb position
REV F/R	F63–R63	Front/rear reverb position
REV LVL	0–100%	Reverb level
REV CTRL	OFF, NOR, INV	1
POS RAD.	0–63	Radius of the panning track at the listening position
ER RAD.	0–63	Radius of the panning track for early reflections
REV RAD.	0–63	Radius of the panning track for reverb

- When set to NOR, the position can be set by using the Joystick so long as the SELECTED CHANNEL PAN/SURROUND [EFFECT] button's indicator is on. When set to INV, the Joystick will work inversely. When set to OFF, joystick control is off.

## OCTA REVERB

Eight input, eight output reverb.

Parameter	Range	Description
REV TIME	0.3–99.0 s	Reverb time
REV TYPE	Hall, Room, Stage, Plate	Reverb type
INI. DLY	0.0–100.0 ms	Initial delay before reverb begins
HI. RATIO	0.1–1.0	High-frequency reverb time ratio
LO. RATIO	0.1–2.4	Low-frequency reverb time ratio
DIFF.	0–10	Reverb diffusion (left–right reverb spread)
DENSITY	0–100%	Reverb density
E/R BAL.	0–100%	Balance of early reflections and reverb (0% = all reverb, 100% = all early reflections)
HPF	THRU, 21.2 Hz–8.00 kHz	High-pass filter cutoff frequency
LPF	50.0 Hz–16.0 kHz, THRU	Low-pass filter cutoff frequency

## AUTO PAN 5.1

Six input, six output autopanner for 5.1 surround.

Parameter	Range	Description
<b>SOURCE</b>	OFF, HOLD, INPUT1, INPUT2, INPUT3, INPUT4, INPUT5, INPUT6, MIDI	Source specifies the trigger that will initiate auto pan. When you press the TRIGGER button in the screen, auto pan will begin regardless of the setting of this parameter. OFF: No trigger is specified. Auto pan will always be off. HOLD: No trigger is specified. Auto pan will always be on. INPUT 1-6: The input signal to effect inputs 1-6 will be the trigger. MIDI: MIDI note-on messages will be the trigger.
<b>TRG LVL</b>	-60 to 0 dB	If SOURCE is set to INPUT, any signal with a level greater than the setting of this parameter will be detected as a trigger.
<b>TRG MASK</b>	0–1000 ms	Trigger Mask specifies the time from when a trigger is received until the next trigger will be accepted.
<b>TIME</b>	0.1 s–10.0 s	The time after which autopan starts once it's been triggered
<b>SPEED</b>	0.05–40.00 Hz	Autopan speed
<b>DIR.</b>	Turn L, Turn R	Autopan direction
<b>OFFSET</b>	-180 to +180 degrees	Pan offset
<b>HPF</b>	THRU, 21.2 Hz–8.00 kHz	High-pass filter cutoff frequency
<b>LPF</b>	50.0 Hz–16.0 kHz, THRU	Low-pass filter cutoff frequency

- When you press the RESET button, the phase will be initialized to the setting of the OFFSET parameter.

## CHORUS 5.1

Six input, six output chorus for 5.1 surround.

Parameter	Range	Description
<b>FREQ.</b>	0.05–40.00 Hz	Modulation speed
<b>AM DEPTH</b>	0–100%	Amplitude modulation depth
<b>PM DEPTH</b>	0–100%	Pitch modulation depth
<b>MOD. DLY</b>	0.0–400.0 ms	Modulation delay time
<b>WAVE</b>	Sine, Tri	Modulation waveform
<b>HPF</b>	THRU, 21.2 Hz–8.00 kHz	High-pass filter cutoff frequency
<b>LPF</b>	50.0 Hz–16.0 kHz, THRU	Low-pass filter cutoff frequency
<b>SYNC</b>	OFF, ON	Tempo parameter sync on/off
<b>NOTE</b>	1	Used in conjunction with TEMPO to determine FREQ.

1. 

### FLANGE 5.1

Six input, six output flanger for 5.1 surround.

Parameter	Range	Description
FREQ.	0.05–40.00 Hz	Modulation speed
DEPTH	0–100%	Modulation depth
MOD. DLY	0.0–400.0 ms	Modulation delay time
FB. GAIN	–99 to +99%	Feedback gain (plus values for normal-phase feedback, minus values for reverse-phase feedback)
WAVE	Sine, Tri	Modulation waveform
HPF	THRU, 21.2 Hz–8.00 kHz	High-pass filter cutoff frequency
LPF	50.0 Hz–16.0 kHz, THRU	Low-pass filter cutoff frequency
SYNC	OFF, ON	Tempo parameter sync on/off
NOTE	1	Used in conjunction with TEMPO to determine FREQ.

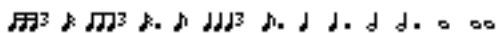
1. 

### SYMPHO. 5.1

Six input, six output symphonic effect for 5.1 surround.

Parameter	Range	Description
FREQ.	0.05–40.00 Hz	Modulation speed
DEPTH	0–100%	Modulation depth
MOD. DLY	0.0–400.0 ms	Modulation delay time
WAVE	Sine, Tri	Modulation waveform
HPF	THRU, 21.2 Hz–8.00 kHz	High-pass filter cutoff frequency
LPF	50.0 Hz–16.0 kHz, THRU	Low-pass filter cutoff frequency
SYNC	OFF, ON	Tempo parameter sync on/off
NOTE	1	Used in conjunction with TEMPO to determine FREQ.

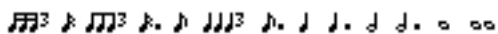
1. 



**M.BAND DYNA.**

Two input, two output 3-band dynamics processor, with individual solo and gain reduction metering for each band.

Parameter	Range	Description
<b>LOW GAIN</b>	-96.0 to +12.0 dB	Low band level
<b>MID GAIN</b>	-96.0 to +12.0 dB	Mid band level
<b>HI. GAIN</b>	-96.0 to +12.0 dB	High band level
<b>PRESENCE</b>	-10 to +10	For positive values, the threshold of the high band is lowered and the threshold of the low band is increased. For negative values, the opposite will occur. When set to 0, all three bands are affected the same.
<b>CMP. THRE</b>	24.0 to 0.0 dB	Compressor threshold
<b>CMP. RAT</b>	1:1 to 20:1	Compressor ratio
<b>CMP. ATK</b>	0–120 ms	Compressor attack
<b>CMP. REL</b>	1	Compressor release time
<b>CMP. KNEE</b>	0–5	Compressor knee
<b>LOOKUP</b>	0.0–100.0 ms	Lookup delay
<b>CMP. BYP</b>	OFF, ON	Compressor bypass
<b>L–M XOVR</b>	21.2 Hz–8.00 kHz	Low/mid crossover frequency
<b>M–H XOVR</b>	21.2 Hz–8.00 kHz	Mid/high crossover frequency
<b>SLOPE</b>	-6 to -12 dB	Filter slope
<b>CEILING</b>	-6.0 to 0.0 dB, OFF	Specifies the maximum output level
<b>EXP. THRE</b>	-54.0 to -24.0 dB	Expander threshold
<b>EXP. RAT</b>	1:1 to ∞:1	Expander ratio
<b>EXP. REL</b>	1	Expander release time
<b>EXP. BYP</b>	OFF, ON	Expander bypass
<b>LIM. THRE</b>	-12.0 to 0.0 dB	Limiter threshold
<b>LIM. ATK</b>	0–120 ms	Limiter attack
<b>LIM. REL</b>	1	Limiter release time
<b>LIM. BYP</b>	OFF, ON	Limiter bypass
<b>LIM. KNEE</b>	0–5	Limiter knee
<b>SOLO LOW</b>	OFF, ON	If this is on, only the low-frequency band will be output.
<b>SOLO MID</b>	OFF, ON	If this is on, only the mid-frequency band will be output.
<b>SOLO HIGH</b>	OFF, ON	If this is on, only the high-frequency band will be output.

1. 6 ms–46.0 s (fs=44.1 kHz), 5 ms–42.3 s (fs=48 kHz), 3 ms–23.0 s (fs=88.2 kHz), 3 ms–21.1 s (fs=96 kHz)

**COMP 5.1**

Six input, six output compressor for 5.1 surround, with individual solo for each band, and gain reduction metering of left and right (L+R), left surround and right surround (LS+RS), center (C), or LFE channels.

Parameter	Range	Description
<b>LOW GAIN</b>	-96.0 to +12.0 dB	Low band level
<b>MID GAIN</b>	-96.0 to +12.0 dB	Mid band level
<b>HI. GAIN</b>	-96.0 to +12.0 dB	High band level
<b>PRESENCE</b>	-10 to +10	For positive values, the threshold of the high band is lowered and the threshold of the low band is increased. For negative values, the opposite will occur. When set to 0, all three bands are affected the same.
<b>THRE.</b>	-24.0 to 0.0 dB	Compressor threshold
<b>RATIO</b>	1:1 to ∞:1	Compressor ratio
<b>ATTACK</b>	0–120 ms	Compressor attack
<b>RELEASE</b>	1	Compressor release time
<b>KNEE</b>	0–5	Compressor knee
<b>LOOKUP</b>	0.0–100.0 ms	Lookup delay
<b>KEY LINK</b>	2	Key-in linking
<b>L–M XOVR</b>	21.2 Hz–8.00 kHz	Low/mid crossover frequency
<b>M–H XOVR</b>	21.2 Hz–8.00 kHz	Mid/high crossover frequency
<b>SLOPE</b>	-6 to -12 dB	Filter slope
<b>CEILING</b>	-6.0 to 0.0 dB, OFF	Specifies the maximum output level
<b>SOLO LOW</b>	OFF, ON	If this is on, only the low-frequency band will be output.
<b>SOLO MID</b>	OFF, ON	If this is on, only the mid-frequency band will be output.
<b>SOLO HIGH</b>	OFF, ON	If this is on, only the high-frequency band will be output.

- 6 ms–46.0 s (fs=44.1 kHz), 5 ms–42.3 s (fs=48 kHz), 3 ms–23.0 s (fs=88.2 kHz), 3 ms–21.1 s (fs=96 kHz)
- 5.1: Key-in's of all inputs are linked  
5.0: Key-in's of L, C, R, LS, and RS are linked (LFE is independent)  
3+2: Key-in's of L, C, and R, and key-in's of LS and RS, are linked respectively (LFE is independent)  
2+2: Key-in's of L and R, and key-in's of LS and RS, are linked respectively (C and LFE are independent)

**COMPAND 5.1**

Six input, six output compander for 5.1 surround, with individual solo for each band, and gain reduction metering of left and right (L+R), left surround and right surround (LS+RS), center (C), or LFE channels.

Parameter	Range	Description
<b>LOW GAIN</b>	-96.0 to +12.0 dB	Low band level
<b>MID GAIN</b>	-96.0 to +12.0 dB	Mid band level
<b>HI. GAIN</b>	-96.0 to +12.0 dB	High band level
<b>PRESENCE</b>	-10 to +10	For positive values, the threshold of the high band is lowered and the threshold of the low band is increased. For negative values, the opposite will occur. When set to 0, all three bands are affected the same.
<b>THRE.</b>	-24.0 to 0.0 dB	Compressor threshold
<b>RATIO</b>	1:1 to 20:1	Compressor ratio
<b>ATTACK</b>	0–120 ms	Attack time
<b>RELEASE</b>	1	Release time
<b>WIDTH</b>	1–90 dB	Compressor effect range and expander effect width
<b>TYPE</b>	Soft, Hard	Companer type
<b>LOOKUP</b>	0.0–100.0 ms	Lookup delay
<b>KEY LINK</b>	<sup>2</sup>	Key-in linking
<b>L–M XOVR</b>	21.2 Hz–8.00 kHz	Low/mid crossover frequency
<b>M–H XOVR</b>	21.2 Hz–8.00 kHz	Mid/high crossover frequency
<b>SLOPE</b>	-6 to -12 dB	Filter slope
<b>CEILING</b>	-6.0 to 0.0 dB, OFF	Specifies the maximum output level
<b>SOLO LOW</b>	OFF, ON	If this is on, only the low-frequency band will be output.
<b>SOLO MID</b>	OFF, ON	If this is on, only the mid-frequency band will be output.
<b>SOLO HIGH</b>	OFF, ON	If this is on, only the high-frequency band will be output.

- 6 ms–46.0 s (fs=44.1 kHz), 5 ms–42.3 s (fs=48 kHz), 3 ms–23.0 s (fs=88.2 kHz), 3 ms–21.1 s (fs=96 kHz)
- 5.1: Key-in's of all inputs are linked  
5.0: Key-in's of L, C, R, LS, and RS are linked (LFE is independent)  
3+2: Key-in's of L, C, and R, and key-in's of LS and RS, are linked respectively (LFE is independent)  
2+2: Key-in's of L and R, and key-in's of LS and RS, are linked respectively (C and LFE are independent)

## Preset EQ Parameters

#	Title	Parameter				
			LOW	L-MID	H-MID	HIGH
01	Bass Drum 1		PEAKING	PEAKING	PEAKING	H.SHELF
		G	+3.5 dB	-3.5 dB	0.0 dB	+4.0 dB
		F	100 Hz	265 Hz	1.06 kHz	5.30 kHz
		Q	1.2	10	0.9	—
02	Bass Drum 2		PEAKING	PEAKING	PEAKING	LPF
		G	+8.0 dB	-7.0 dB	+6.0 dB	ON
		F	80 Hz	400 Hz	2.50 kHz	12.5 kHz
		Q	1.4	4.5	2.2	—
03	Snare Drum 1		PEAKING	PEAKING	PEAKING	H.SHELF
		G	-0.5 dB	0.0 dB	+3.0 dB	+4.5 dB
		F	132 Hz	1.00 kHz	3.15 kHz	5.00 kHz
		Q	1.2	4.5	0.11	—
04	Snare Drum 2		L.SHELF	PEAKING	PEAKING	PEAKING
		G	+1.5 dB	-8.5 dB	+2.5 dB	+4.0 dB
		F	180 Hz	335 Hz	2.36 kHz	4.00 kHz
		Q	—	10	0.7	0.1
05	Tom-tom 1		PEAKING	PEAKING	PEAKING	PEAKING
		G	+2.0 dB	-7.5 dB	+2.0 dB	+1.0 dB
		F	212 Hz	670 Hz	4.50 kHz	6.30 kHz
		Q	1.4	10	1.2	0.28
06	Cymbal		L.SHELF	PEAKING	PEAKING	H.SHELF
		G	-2.0 dB	0.0 dB	0.0 dB	+3.0 dB
		F	106 Hz	425 Hz	1.06 kHz	13.2 kHz
		Q	—	8	0.9	—
07	High Hat		L.SHELF	PEAKING	PEAKING	H.SHELF
		G	-4.0 dB	-2.5 dB	+1.0 dB	+0.5 dB
		F	95 Hz	425 Hz	2.80 kHz	7.50 kHz
		Q	—	0.5	1	—
08	Percussion		L.SHELF	PEAKING	PEAKING	H.SHELF
		G	-4.5 dB	0.0 dB	+2.0 dB	0.0 dB
		F	100 Hz	400 Hz	2.80 kHz	17.0 kHz
		Q	—	4.5	0.56	—
09	E. Bass 1		L.SHELF	PEAKING	PEAKING	H.SHELF
		G	-7.5 dB	+4.5 dB	+2.5 dB	0.0 dB
		F	35.5 Hz	112 Hz	2.00 kHz	4.00 kHz
		Q	—	5	4.5	—
10	E. Bass 2		PEAKING	PEAKING	PEAKING	H.SHELF
		G	+3.0 dB	0.0 dB	+2.5 dB	+0.5 dB
		F	112 Hz	112 Hz	2.24 kHz	4.00 kHz
		Q	0.1	5	6.3	—

#	Title	Parameter				
			LOW	L-MID	H-MID	HIGH
11	Syn. Bass 1		PEAKING	PEAKING	PEAKING	H.SHELF
		G	+3.5 dB	+8.5 dB	0.0 dB	0.0 dB
		F	85 Hz	950 Hz	4.00 kHz	12.5 kHz
		Q	0.1	8	4.5	—
12	Syn. Bass 2		PEAKING	PEAKING	PEAKING	H.SHELF
		G	+2.5 dB	0.0 dB	+1.5 dB	0.0 dB
		F	125 Hz	180 Hz	1.12 kHz	12.5 kHz
		Q	1.6	8	2.2	—
13	Piano 1		L.SHELF	PEAKING	PEAKING	H.SHELF
		G	-6.0 dB	0.0 dB	+2.0 dB	+4.0 dB
		F	95 Hz	950 Hz	3.15 kHz	7.50 kHz
		Q	—	8	0.9	—
14	Piano 2		PEAKING	PEAKING	PEAKING	H.SHELF
		G	+3.5 dB	-8.5 dB	+1.5 dB	+3.0 dB
		F	224 Hz	600 Hz	3.15 kHz	5.30 kHz
		Q	5.6	10	0.7	—
15	E. G. Clean		PEAKING	PEAKING	PEAKING	H.SHELF
		G	+2.0 dB	-5.5 dB	+0.5 dB	+2.5 dB
		F	265 Hz	400 Hz	1.32 kHz	4.50 kHz
		Q	0.18	10	6.3	—
16	E. G. Crunch 1		PEAKING	PEAKING	PEAKING	PEAKING
		G	+4.5 dB	0.0 dB	+4.0 dB	+2.0 dB
		F	140 Hz	1.00 kHz	1.90 kHz	5.60 kHz
		Q	8	4.5	0.63	9
17	E. G. Crunch 2		PEAKING	PEAKING	PEAKING	H.SHELF
		G	+2.5 dB	+1.5 dB	+2.5 dB	0.0 dB
		F	125 Hz	450 Hz	3.35 kHz	19.0 kHz
		Q	8	0.4	0.16	—
18	E. G. Dist. 1		L.SHELF	PEAKING	PEAKING	H.SHELF
		G	+5.0 dB	0.0 dB	+3.5 dB	0.0 dB
		F	355 Hz	950 Hz	3.35 kHz	12.5 kHz
		Q	—	9	10	—
19	E. G. Dist. 2		L.SHELF	PEAKING	PEAKING	H.SHELF
		G	+6.0 dB	-8.5 dB	+4.5 dB	+4.0 dB
		F	315 Hz	1.06 kHz	4.25 kHz	12.5 kHz
		Q	—	10	4	—
20	A. G. Stroke 1		PEAKING	PEAKING	PEAKING	H.SHELF
		G	-2.0 dB	0.0 dB	+1.0 dB	+4.0 dB
		F	106 Hz	1.00 kHz	1.90 kHz	5.30 kHz
		Q	0.9	4.5	3.5	—
21	A. G. Stroke 2		L.SHELF	PEAKING	PEAKING	H.SHELF
		G	-3.5 dB	-2.0 dB	0.0 dB	+2.0 dB
		F	300 Hz	750 Hz	2.00 kHz	3.55 kHz
		Q	—	9	4.5	—

#	Title	Parameter				
			LOW	L-MID	H-MID	HIGH
22	A. G. Arpeg. 1		L.SHELF	PEAKING	PEAKING	PEAKING
		G	-0.5 dB	0.0 dB	0.0 dB	+2.0 dB
		F	224 Hz	1.00 kHz	4.00 kHz	6.70 kHz
		Q	—	4.5	4.5	0.12
23	A. G. Arpeg. 2		L.SHELF	PEAKING	PEAKING	H.SHELF
		G	0.0 dB	-5.5 dB	0.0 dB	+4.0 dB
		F	180 Hz	355 Hz	4.00 kHz	4.25 kHz
		Q	—	7	4.5	—
24	Brass Sec.		PEAKING	PEAKING	PEAKING	PEAKING
		G	-2.0 dB	-1.0 dB	+1.5 dB	+3.0 dB
		F	90 Hz	850 Hz	2.12 kHz	4.50 kHz
		Q	2.8	2	0.7	7
25	Male Vocal 1		PEAKING	PEAKING	PEAKING	PEAKING
		G	-0.5 dB	0.0 dB	+2.0 dB	+3.5 dB
		F	190 Hz	1.00 kHz	2.00 kHz	6.70 kHz
		Q	0.11	4.5	0.56	0.11
26	Male Vocal 2		PEAKING	PEAKING	PEAKING	H.SHELF
		G	+2.0 dB	-5.0 dB	-2.5 dB	+4.0 dB
		F	170 Hz	236 Hz	2.65 kHz	6.70 kHz
		Q	0.11	10	5.6	—
27	Female Vo. 1		PEAKING	PEAKING	PEAKING	PEAKING
		G	-1.0 dB	+1.0 dB	+1.5 dB	+2.0 dB
		F	118 Hz	400 Hz	2.65 kHz	6.00 kHz
		Q	0.18	0.45	0.56	0.14
28	Female Vo. 2		L.SHELF	PEAKING	PEAKING	H.SHELF
		G	-7.0 dB	+1.5 dB	+1.5 dB	+2.5 dB
		F	112 Hz	335 Hz	2.00 kHz	6.70 kHz
		Q	—	0.16	0.2	—
29	Chorus & Harmo		PEAKING	PEAKING	PEAKING	PEAKING
		G	-2.0 dB	-1.0 dB	+1.5 dB	+3.0 dB
		F	90 Hz	850 Hz	2.12 kHz	4.50 kHz
		Q	2.8	2	0.7	7
30	Total EQ 1		PEAKING	PEAKING	PEAKING	H.SHELF
		G	-0.5 dB	0.0 dB	+3.0 dB	+6.5 dB
		F	95 Hz	950 Hz	2.12 kHz	16.0 kHz
		Q	7	2.2	5.6	—
31	Total EQ 2		PEAKING	PEAKING	PEAKING	H.SHELF
		G	+4.0 dB	+1.5 dB	+2.0 dB	+6.0 dB
		F	95 Hz	750 Hz	1.80 kHz	18.0 kHz
		Q	7	2.8	5.6	—
32	Total EQ 3		L.SHELF	PEAKING	PEAKING	H.SHELF
		G	+1.5 dB	+0.5 dB	+2.0 dB	+4.0 dB
		F	67 Hz	850 Hz	1.90 kHz	15.0 kHz
		Q	—	0.28	0.7	—

#	Title	Parameter				
			LOW	L-MID	H-MID	HIGH
33	Bass Drum 3		PEAKING	PEAKING	PEAKING	PEAKING
		G	+3.5 dB	-10.0 dB	+3.5 dB	0.0 dB
		F	118 Hz	315 Hz	4.25 kHz	20.0 kHz
		Q	2	10	0.4	0.4
34	Snare Drum 3		L.SHELF	PEAKING	PEAKING	PEAKING
		G	0.0 dB	+2.0 dB	+3.5 dB	0.0 dB
		F	224 Hz	560 Hz	4.25 kHz	4.00 kHz
		Q	—	4.5	2.8	0.1
35	Tom-tom 2		L.SHELF	PEAKING	PEAKING	H.SHELF
		G	-9.0 dB	+1.5 dB	+2.0 dB	0.0 dB
		F	90 Hz	212 Hz	5.30 kHz	17.0 kHz
		Q	—	4.5	1.2	—
36	Piano 3		PEAKING	PEAKING	PEAKING	H.SHELF
		G	+4.5 dB	-13.0 dB	+4.5 dB	+2.5 dB
		F	100 Hz	475 Hz	2.36 kHz	10.0 kHz
		Q	8	10	9	—
37	Piano Low		PEAKING	PEAKING	PEAKING	H.SHELF
		G	-5.5 dB	+1.5 dB	+6.0 dB	0.0 dB
		F	190 Hz	400 Hz	6.70 kHz	12.5 kHz
		Q	10	6.3	2.2	—
38	Piano High		PEAKING	PEAKING	PEAKING	PEAKING
		G	-5.5 dB	+1.5 dB	+5.0 dB	+3.0 dB
		F	190 Hz	400 Hz	6.70 kHz	5.60 kHz
		Q	10	6.3	2.2	0.1
39	Fine-EQ Cass		L.SHELF	PEAKING	PEAKING	H.SHELF
		G	-1.5 dB	0.0 dB	+1.0 dB	+3.0 dB
		F	75 Hz	1.00 kHz	4.00 kHz	12.5 kHz
		Q	—	4.5	1.8	—
40	Narrator		PEAKING	PEAKING	PEAKING	H.SHELF
		G	-4.0 dB	-1.0 dB	+2.0 dB	0.0 dB
		F	106 Hz	710 Hz	2.50 kHz	10.0 kHz
		Q	4	7	0.63	—

## Preset Gate Parameters ( $f_s = 44.1$ kHz)

#	Title	Type	Parameter	Value
1	Gate	GATE	Threshold (dB)	-26
			Range (dB)	-56
			Attack (ms)	0
			Hold (ms)	2.56
			Decay (ms)	331
2	Ducking	DUCKING	Threshold (dB)	-19
			Range (dB)	-22
			Attack (ms)	93
			Hold (ms)	1.20 S
			Decay (ms)	6.32 S
3	A. Dr. BD	GATE	Threshold (dB)	-11
			Range (dB)	-53
			Attack (ms)	0
			Hold (ms)	1.93
			Decay (ms)	400
4	A. Dr. SN	GATE	Threshold (dB)	-8
			Range (dB)	-23
			Attack (ms)	1
			Hold (ms)	0.63
			Decay (ms)	238

## Preset Compressor Parameters ( $f_s = 44.1$ kHz)

#	Title	Type	Parameter	Value
1	Comp	COMP	Threshold (dB)	-8
			Ratio ( :1)	2.5
			Attack (ms)	60
			Out gain (dB)	0.0
			Knee	2
			Release (ms)	250
2	Expand	EXPAND	Threshold (dB)	-23
			Ratio ( :1)	1.7
			Attack (ms)	1
			Out gain (dB)	3.5
			Knee	2
			Release (ms)	70
3	Compander (H)	COMPAND-H	Threshold (dB)	-10
			Ratio ( :1)	3.5
			Attack (ms)	1
			Out gain (dB)	0.0
			Width (dB)	6
			Release (ms)	250
4	Compander (S)	COMPAND-S	Threshold (dB)	-8
			Ratio ( :1)	4
			Attack (ms)	25
			Out gain (dB)	0.0
			Width (dB)	24
			Release (ms)	180



#	Title	Type	Parameter	Value
5	A. Dr. BD	COMP	Threshold (dB)	-24
			Ratio ( :1)	3
			Attack (ms)	9
			Out gain (dB)	5.5
			Knee	2
			Release (ms)	58
6	A. Dr. BD	COMPAND-H	Threshold (dB)	-11
			Ratio ( :1)	3.5
			Attack (ms)	1
			Out gain (dB)	-1.5
			Width (dB)	7
			Release (ms)	192
7	A. Dr. SN	COMP	Threshold (dB)	-17
			Ratio ( :1)	2.5
			Attack (ms)	8
			Out gain (dB)	3.5
			Knee	2
			Release (ms)	12
8	A. Dr. SN	EXPAND	Threshold (dB)	-23
			Ratio ( :1)	2
			Attack (ms)	0
			Out gain (dB)	0.5
			Knee	2
			Release (ms)	151
9	A. Dr. SN	COMPAND-S	Threshold (dB)	-8
			Ratio ( :1)	1.7
			Attack (ms)	11
			Out gain (dB)	0.0
			Width (dB)	10
			Release (ms)	128
10	A. Dr. Tom	EXPAND	Threshold (dB)	-20
			Ratio ( :1)	2
			Attack (ms)	2
			Out gain (dB)	5.0
			Knee	2
			Release (ms)	749
11	A. Dr. OverTop	COMPAND-S	Threshold (dB)	-24
			Ratio ( :1)	2
			Attack (ms)	38
			Out gain (dB)	-3.5
			Width (dB)	54
			Release (ms)	842
12	E. B. Finger	COMP	Threshold (dB)	-12
			Ratio ( :1)	2
			Attack (ms)	15
			Out gain (dB)	4.5
			Knee	2
			Release (ms)	470

#	Title	Type	Parameter	Value
13	E. B. Slap	COMP	Threshold (dB)	-12
			Ratio ( :1)	1.7
			Attack (ms)	6
			Out gain (dB)	4.0
			Knee	hard
			Release (ms)	133
14	Syn. Bass	COMP	Threshold (dB)	-10
			Ratio ( :1)	3.5
			Attack (ms)	9
			Out gain (dB)	3.0
			Knee	hard
			Release (ms)	250
15	Piano1	COMP	Threshold (dB)	-9
			Ratio ( :1)	2.5
			Attack (ms)	17
			Out gain (dB)	1.0
			Knee	hard
			Release (ms)	238
16	Piano2	COMP	Threshold (dB)	-18
			Ratio ( :1)	3.5
			Attack (ms)	7
			Out gain (dB)	6.0
			Knee	2
			Release (ms)	174
17	E. Guitar	COMP	Threshold (dB)	-8
			Ratio ( :1)	3.5
			Attack (ms)	7
			Out gain (dB)	2.5
			Knee	4
			Release (ms)	261
18	A. Guitar	COMP	Threshold (dB)	-10
			Ratio ( :1)	2.5
			Attack (ms)	5
			Out gain (dB)	1.5
			Knee	2
			Release (ms)	238
19	Strings1	COMP	Threshold (dB)	-11
			Ratio ( :1)	2
			Attack (ms)	33
			Out gain (dB)	1.5
			Knee	2
			Release (ms)	749
20	Strings2	COMP	Threshold (dB)	-12
			Ratio ( :1)	1.5
			Attack (ms)	93
			Out gain (dB)	1.5
			Knee	4
			Release (ms)	1.35 S

#	Title	Type	Parameter	Value
21	Strings3	COMP	Threshold (dB)	-17
			Ratio ( :1)	1.5
			Attack (ms)	76
			Out gain (dB)	2.5
			Knee	2
			Release (ms)	186
22	BrassSection	COMP	Threshold (dB)	-18
			Ratio ( :1)	1.7
			Attack (ms)	18
			Out gain (dB)	4.0
			Knee	1
			Release (ms)	226
23	Syn. Pad	COMP	Threshold (dB)	-13
			Ratio ( :1)	2
			Attack (ms)	58
			Out gain (dB)	2.0
			Knee	1
			Release (ms)	238
24	SamplingPerc	COMPAND-S	Threshold (dB)	-18
			Ratio ( :1)	1.7
			Attack (ms)	8
			Out gain (dB)	-2.5
			Width (dB)	18
			Release (ms)	238
25	Sampling BD	COMP	Threshold (dB)	-14
			Ratio ( :1)	2
			Attack (ms)	2
			Out gain (dB)	3.5
			Knee	4
			Release (ms)	35
26	Sampling SN	COMP	Threshold (dB)	-18
			Ratio ( :1)	4
			Attack (ms)	8
			Out gain (dB)	8.0
			Knee	hard
			Release (ms)	354
27	Hip Comp	COMPAND-S	Threshold (dB)	-23
			Ratio ( :1)	20
			Attack (ms)	15
			Out gain (dB)	0.0
			Width (dB)	15
			Release (ms)	163
28	Solo Vocal1	COMP	Threshold (dB)	-20
			Ratio ( :1)	2.5
			Attack (ms)	31
			Out gain (dB)	2.0
			Knee	1
			Release (ms)	342

#	Title	Type	Parameter	Value
29	Solo Vocal2	COMP	Threshold (dB)	-8
			Ratio ( :1)	2.5
			Attack (ms)	26
			Out gain (dB)	1.5
			Knee	3
			Release (ms)	331
30	Chorus	COMP	Threshold (dB)	-9
			Ratio ( :1)	1.7
			Attack (ms)	39
			Out gain (dB)	2.5
			Knee	2
			Release (ms)	226
31	Click Erase	EXPAND	Threshold (dB)	-33
			Ratio ( :1)	2
			Attack (ms)	1
			Out gain (dB)	2.0
			Knee	2
			Release (ms)	284
32	Announcer	COMPAND-H	Threshold (dB)	-14
			Ratio ( :1)	2.5
			Attack (ms)	1
			Out gain (dB)	-2.5
			Width (dB)	18
			Release (ms)	180
33	Limiter1	COMPAND-S	Threshold (dB)	-9
			Ratio ( :1)	3
			Attack (ms)	20
			Out gain (dB)	-3.0
			Width (dB)	90
			Release (ms)	3.90 s
34	Limiter2	COMP	Threshold (dB)	0
			Ratio ( :1)	∞
			Attack (ms)	0
			Out gain (dB)	0.0
			Knee	hard
			Release (ms)	319
35	Total Comp1	COMP	Threshold (dB)	-18
			Ratio ( :1)	3.5
			Attack (ms)	94
			Out gain (dB)	2.5
			Knee	hard
			Release (ms)	447
36	Total Comp2	COMP	Threshold (dB)	-16
			Ratio ( :1)	6
			Attack (ms)	11
			Out gain (dB)	6.0
			Knee	1
			Release (ms)	180

# Appendix B: Specifications

## General Spec

Number of scene memories		99
Sampling Frequency	Internal	44.1 kHz, 48 kHz, 88.2 kHz, 96 kHz
	External	Normal rate: 44.1 kHz–10% to 48 kHz+6% Double rate: 88.2 kHz–10% to 96 kHz+6%
Signal Delay	fs=48 kHz	Less than 1.6 ms CH INPUT to OMNI OUT
	fs=96 kHz	Less than 0.8 ms CH INPUT to OMNI OUT
Fader		100 mm motorized with touch sense × 17
Fader Resolution		+10 to –138, –∞ dB input faders 0 to –138, –∞ dB master faders, stereo fader
Total Harmonic Distortion <sup>1</sup> (CH INPUT to OMNI OUT) (Input Gain=Min.)	fs=48 kHz	Less than 0.05% 20 Hz to 20 kHz @ +14 dB into 600 Ω Less than 0.01% 1 kHz @ +24 dB into 600 Ω
	fs=96 kHz	Less than 0.05% 20 Hz to 40 kHz @ +14 dB into 600 Ω Less than 0.01% 1 kHz @ +24 dB into 600 Ω
Frequency Response (CH INPUT to OMNI OUT)	fs=48 kHz	20 Hz–20 kHz, 0.5, –1.5 dB @ +4 dB into 600 Ω
	fs=96 kHz	20 Hz–40 kHz, 0.5, –1.5 dB @ +4 dB into 600 Ω
Dynamic Range (maximum level to noise level)		110 dB typ. DA Converter (OMNI OUT) 106 dB typ. AD+DA (to OMNI OUT) @ fs=48 kHz 106 dB typ. AD+DA (to OMNI OUT) @ fs=96 kHz
Hum & Noise <sup>2</sup> (20 Hz–20 kHz) Rs=150 Ω		–128 dB Equivalent Input Noise
		–86 dB residual output noise. OMNI OUT (STEREO OUT off)
		Input Gain=Max. Input Pad =0 dB
		–86 dB (90 dB S/N) OMNI OUT (STEREO fader at nominal level and all CH INPUT faders at minimum level)
		Input Pad =0 dB Input Sensitivity =–60 dB
		–64 dB (68 dB S/N) OMNI OUT (STEREO fader at nominal level and one CH INPUT fader at nominal level)
Maximum Voltage Gain		74 dB CH INPUT (CH1–16) to OMNI OUT (STEREO, BUS, AUX)
Crosstalk (@ 1 kHz) Input Gain=Min.		80 dB adjacent input channels (CH1–16) 80 dB input to output
AD Input (1–16)	Phantom switch	+48 V DC
	Pad switch	0/20 dB attenuation
	Gain control	44 dB (–60 to –16), detented
	Peak indicator	LED (red) turns on when post HA level reaches 3 dB below clipping at digital domain
	Signal indicator	LED (green) turns on when post HA level reaches 20 dB below nominal at digital domain
	AD converter	24-bit linear, 128-times oversampling (fs=44.1, 48 kHz), 64-times oversampling (fs=88.2, 96 kHz)
Analog Input (OMNI IN 1–4)	AD converter	24-bit linear, 128-times oversampling (fs=44.1, 48 kHz), 64-times oversampling (fs=88.2, 96 kHz)
Option Input (SLOT 1–2)	Available cards	Optional digital interface cards (MY16, MY8, MY4 series)
Digital Input (2TR IN DIGITAL 1–2)	SRC	On/off (1:3 and 3:1 maximum input to output sample rate ratio)

Input Channel CH1–48	Input patch	—	
	Phase	Normal/reverse	
	Gate-type <sup>3</sup>	On/off	
		Key in: 12 ch Group (1–12, 13–24, 25–36, 37–48)/AUX1–8	
	Comp-type <sup>4</sup>	On/off	
		Key in: self /Stereo Link	
		Pre EQ/pre fader/post fader	
	Attenuator	–96.0 to +12.0 dB (0.1 dB step)	
	EQ	4-band PEQ (TYPE1) <sup>5</sup>	
		On/off	
	Delay	0–43400 samples	
	On/off	—	
	Fader	100 mm motorized (INPUT/AUX1–8)	
	Aux send	On/off	
		AUX1–8; pre fader/post fader	
	Solo	On/off	
		Pre fader/after pan	
Pan	127 positions (Left= 1–63, Center, Right= 1–63)		
Surround pan	127 × 127 positions [(Left= 1–63, Center, Right= 1–63)] × [(Front= 1–63, Center, Rear= 1–63)]		
LFE level	–∞, –96 dB to +10 dB (256 step)		
Routing	STEREO, BUS1–8, DIRECT OUT		
Direct out	Pre EQ/pre fader/post fader		
Metering	Displayed on LCD		
	Peak hold on/off		
TALKBACK	Level control	Analog rotary potentiometer	
	AD converter	24-bit linear, 128-times oversampling (@fs=44.1, 48 kHz), 64-times oversampling (@fs=88.2, 96 kHz)	
	Talkback select	Built-in microphone/AD IN 1–16/OMNI IN 1–4	
	On/off	—	
OSCILLATOR	Level	0 to –96 dB (1 dB step)	
	On/off	—	
	Waveform	Sine 100 Hz, sine 1 kHz, sine 10 kHz, 400 Hz/1 kHz, pink noise, burst noise	
	Routing	BUS1–8, AUX1–8, STEREO L, R	
OMNI OUT 1–12	Output patch	STEREO, BUS1–8, AUX1–8, SURROUND MONITOR, CONTROL ROOM, DIRECT OUT 1–48, INSERT OUT (CH1–48, BUS1–8, AUX1–8, STEREO), MONITOR MATRIX OUT, SOLO OUT, CASCADE OUT (BUS1–8, AUX 1–8, STEREO, SOLO)	
	DA converter	24-bit linear, 128-times oversampling (@fs=44.1, 48 kHz), 64-times oversampling (@fs=88.2, 96 kHz)	
2TR OUT DIGITAL 1–2	Dither	On/off	
		Word length 16, 20, 24-bit	
Output patch	STEREO, BUS1–8, AUX 1–8, CONTROL ROOM, DIRECT OUT 1–48, INSERT OUT (CH 1–48, BUS 1–8, AUX 1–8, STEREO), SOLO OUT, CASCADE OUT (BUS 1–8, AUX 1–8, STEREO, SOLO)		
Option Output (SLOT 1–2)	Available card	Optional digital interface card (MY16, MY8, MY4 series)	
	Output patch	STEREO, BUS1–8, AUX 1–8, SURROUND MONITOR, CONTROL ROOM, DIRECT OUT 1–48, INSERT OUT (CH 1–48, BUS 1–8, AUX 1–8, STEREO), MONITOR MATRIX OUT, SOLO OUT, CASCADE OUT (BUS 1–8, AUX 1–8, STEREO, SOLO)	
Dither	On/off		
	Word length 16/20/24-bit		

STEREO	Comp-type <sup>4</sup>	On/off
		Pre EQ/pre fader/post fader
	Attenuator	-96.0 to +12.0 dB (0.1 dB step)
	EQ	4-band PEQ <sup>5</sup>
		On/off
	On/off	—
	Fader	100 mm motorized
	Balance	127 positions (Left=1-63, Center, Right=1-63)
	Delay	0-29100 samples
Metering	Displayed on LCD	
	Peak hold on/off	
	32-elements x2 LED meters	
BUS1-8	Comp-type <sup>4</sup>	On/off
		Pre EQ/pre fader/post fader
	Attenuator	-96.0 to +12.0 dB (0.1 dB step)
	EQ	4-band PEQ <sup>5</sup>
		On/off
	On/off	—
	Fader	100 mm motorized
	Delay	0-29100 samples
	Bus to stereo	Level (-∞, -138 dB to 0 dB)
		On/off
Pan: 127 positions (Left=1-63, Center, Right=1-63)		
Metering	Displayed on LCD	
	Peak hold on/off	
AUX1-8	Comp-type <sup>4</sup>	On/off
		Pre EQ/pre fader/post fader
	Attenuator	-96.0 to +12.0 dB (0.1 dB step)
	EQ	4-band PEQ <sup>5</sup>
		On/off
	On/off	—
	Fader	100 mm motorized
	Delay	0-29100 samples
Metering	Displayed on LCD	
	Peak hold on/off	
SURROUND MONITOR	Mute	On/off
	Solo	On/off
	Source	BUS1-8, SLOT 1-2
	Monitor to C-R	On/off
	Oscillator	Pink noise/500-2 kHz/1 kHz
	Monitor matrix	6.1→6.1, 6.1→5.1, 6.1→3-1, 6.1→ST, 5.1→5.1, 5.1→3-1, 5.1→ST, 3-1→3-1, 3-1→ST
	Bass management	5 presets
	Monitor alignment	ATT (-12.0 dB to 12 dB 0.1 dB step), Delay (0-30.0 msec 0.02 msec step)
INTERNAL EFFECTS (EFFECT 1-4)	Bypass	On/off
	In/out	8-in, 8-out (EFFECT1): depends on effects type
		2-in, 2-out (EFFECT2-4): depends on effects type
	Effect-in from	AUX1-8/INSERT OUT/effect-out (out 1, 2 only)
Effect-out 1, 2 to	Input patch/effect-in	

Power Requirements	U.S./Canada	120 V, 60 Hz 135 W
	Other	220–240 V, 50/60 Hz 135 W
Dimensions	(H x D x W)	200 x 585 x 436 mm (7.8" x 23.0" x 17.1") With MB1000 and SP1000 installed: 295 x 635 x 486 mm (11.6" x 25.0" x 19.1")
Net weight		20 kg (75 lbs)
Operating free-air temperature range		10–35°C (50–95°F)
Storage temperature range		–20 to 60°C (–4 to 140°F)
Supplied Accessories		AC Cable, CD-ROM (Studio Manager), Owner’s Manual, Studio Manager Installation Guide
Options		Digital interface card (MY16, MY8, MY4 series) PEAK METER BRIDGE: MB1000 SIDE PANEL: SP1000 RACK MOUNT KIT: RK1

1. Total harmonic distortion is measured with a 6 dB/octave filter @ 80 kHz.
2. Hum & Noise are measured with a 6 dB/octave filter @ 12.7 kHz; equivalent to a 20 kHz filter with infinite dB/octave attenuation.
3. See “Gate Parameters” on page 328.
4. See “Comp Parameters” on page 329.
5. See “EQ Parameters” on page 328.

### EQ Parameters

	LOW/HPF	L-MID	H-MID	HIGH /LPF
Q	0.1–10.0 (41 points) low shelving HPF	0.1–10.0 (41 points)		0.1–10.0 (41 points) high shelving LPF
F	21.2 Hz–20 kHz (1/12 oct step)			
G	±18 dB (0.1 dB step) HPF: on/off	±18 dB (0.1 dB step)		±18 dB (0.1 dB step) LPF: on/off

### Gate Parameters

Gate	Threshold	–54 dB to 0 dB (0.1 dB step)
	Range	–70 dB to 0 dB (1 dB step)
	Attack	0 ms–120 ms (1 ms step)
	Hold	0.02 ms–1.96 s (216 points) @ 48 kHz
		0.02 ms–2.13 s (216 points) @ 44.1 kHz
		0.01 ms–981 ms (216 points) @ 96 kHz
		0.01 ms–1.06 s (216 points) @ 88.2 kHz
	Decay	5 ms–42.3 s (160 points) @ 48 kHz
		6 ms–46.0 s (160 points) @ 44.1 kHz
		3 ms–21.1 s (160 points) @ 96 kHz
3 ms–23.0 s (160 points) @ 88.2 kHz		
Ducking	Threshold	–54 dB to 0 dB (0.1 dB step)
	Range	–70 dB to 0 dB (1 dB step)
	Attack	0 ms–120 ms (1 ms step)
	Hold	0.02 ms–1.96 s (216 points) @ 48 kHz
		0.02 ms–2.13 s (216 points) @ 44.1 kHz
		0.01 ms–981 ms (216 points) @ 96 kHz
		0.01 ms–1.06 s (216 points) @ 88.2 kHz
	Decay	5 ms–42.3 s (160 points) @ 48 kHz
		6 ms–46.0 s (160 points) @ 44.1 kHz
		3 ms–21.1 s (160 points) @ 96 kHz
3 ms–23.0 s (160 points) @ 88.2 kHz		



## Comp Parameters

Compressor	Threshold	-54 dB to 0 dB (0.1 dB step)
	Ratio (x :1)	x=1, 1.1, 1.3, 1.5, 1.7, 2, 2.5, 3, 3.5, 4, 5, 6, 8, 10, 20, ∞ (16 points)
	Out gain	0 dB to +18 dB (0.1 dB step)
	Knee	Hard, 1, 2, 3, 4, 5 (6 step)
	Attack	0 ms–120 ms (1 ms step)
	Release	5 ms–42.3 s (160 points) @ 48 kHz
		6 ms–46.0 s (160 points) @ 44.1 kHz
3 ms–21.1 s (160 points) @ 96 kHz		
3 ms–23.0 s (160 points) @ 88.2 kHz		
Expander	Threshold	-54 dB to 0 dB (0.1 dB step)
	Ratio (x :1)	x=1, 1.1, 1.3, 1.5, 1.7, 2, 2.5, 3, 3.5, 4, 5, 6, 8, 10, 20, ∞ (16 points)
	Out gain	0 dB to +18 dB (0.1 dB step)
	Knee	Hard, 1, 2, 3, 4, 5 (6 points)
	Attack	0 ms–120 ms (1 ms step)
	Release	5 ms–42.3 s (160 points) @ 48 kHz
		6 ms–46.0 s (160 points) @ 44.1 kHz
3 ms–21.1 s (160 points) @ 96 kHz		
3 ms–23.0 s (160 points) @ 88.2 kHz		
Compander H	Threshold	-54 dB to 0 dB (0.1 dB step)
	Ratio (x :1)	x=1, 1.1, 1.3, 1.5, 1.7, 2, 2.5, 3, 3.5, 4, 5, 6, 8, 10, 20 (15 points)
	Out gain	-18 dB to 0 dB (0.1 dB step)
	Width	1 dB–90 dB (1 dB step)
	Attack	0 ms–120 ms (1 ms step)
	Release	5 ms–42.3 s (160 points) @ 48 kHz
		6 ms–46.0 s (160 points) @ 44.1 kHz
3 ms–21.1 s (160 points) @ 96 kHz		
3 ms–23.0 s (160 points) @ 88.2 kHz		
Compander S	Threshold	-54 dB to 0 dB (0.1 dB step)
	Ratio (x :1)	x=1, 1.1, 1.3, 1.5, 1.7, 2, 2.5, 3, 3.5, 4, 5, 6, 8, 10, 20 (15 points)
	Out gain	-18 dB to 0 dB (0.1 dB step)
	Width	1 dB–90 dB (1 dB step)
	Attack	0 ms–120 ms (1 ms step)
	Release	5 ms–42.3 s (160 points) @ 48 kHz
		6 ms–46.0 s (160 points) @ 44.1 kHz
3 ms–21.1 s (160 points) @ 96 kHz		
3 ms–23.0 s (160 points) @ 88.2 kHz		

## Libraries

Effect library (EFFECT 1–4)	Presets	52 (EFFECT 2–4: 44)
	User memories	76
Compressor library	Presets	36
	User memories	92
Gate library	Presets	4
	User memories	124
EQ library	Presets	40
	User memories	160
Channel library	Presets	2
	User memories	127
Surround Monitor library	Presets	1
	User memories	32
Input patch library	Presets	1
	User memories	32
Output patch library	Presets	1
	User memories	32
Bus to Stereo library	Presets	1
	User memories	32

## Analog Input Spec

Input	PAD	GAIN	Actual Load Impedance	For Use With Nominal	Input level			Connector
					Sensitivity <sup>1</sup>	Nominal	Max. before clip	
INPUT 1–16	0	–60 dB	3k Ω	50–600 Ω Mics & 600 Ω Lines	–70 dB (0.245 mV)	–60 dB (0.775 mV)	–40 dB (7.75 mV)	XLR-3-31 type (Balanced) <sup>2</sup>
		–16 dB			–26 dB (38.8 mV)	–16 dB (0.123 V)	+4 dB (1.23 V)	
	20	–6 dB (388 mV)			+4 dB (1.23 V)	+24 dB (12.28 V)		
OMNI IN 1–4	—	—	10k Ω	600 Ω Lines	+4 dB (1.23 V)	+4 dB (1.23 V)	+24 dB (12.28 V)	

1. Sensitivity is the lowest level that will produce an output of +4 dB (1.23 V) or the nominal output level when the unit is set to maximum gain. (All faders and level controls are maximum position.)
2. XLR-3-31 type connectors are balanced (1=GND, 2=HOT, 3=COLD).

In these specifications, when dB represents a specific voltage, 0 dB is referenced to 0.775 Vrms.

All input AD converters (INPUT 1–16, OMNI INPUT 1–4, TALKBACK) are 24-bit linear, 128-times oversampling. (@fs=44.1, 48 kHz)

+48 V DC (phantom power) is supplied to CH INPUT (1–16) XLR type connectors via individual switches.

## Analog Output Spec

Output	Actual Source Impedance	For Use With Nominal	Output level		Connector
			Nominal	Max. before clip	
OMNI OUT 1–12	150 Ω	600 Ω Lines	+4 dB (1.23 V)	+24 dB (12.28 V)	XLR-3-32 type (Balanced) <sup>1</sup>
PHONES	100 Ω	8 Ω Phones	4 mW	25 mW	Stereo Phone Jack (TRS) (Unbalanced) <sup>2</sup>
		40 Ω Phones	12 mW	75 mW	

1. XLR-3-32 type connectors are balanced (1=GND, 2=HOT, 3=COLD).
2. PHONES stereo phone jack is unbalanced (Tip=LEFT, Ring=RIGHT, Sleeve=GND).

In these specifications, when dB represents a specific voltage, 0 dB is referenced to 0.775 Vrms.

All output DA converters (OMINI OUT 1–12, PHONES) are 24-bit, 128-times oversampling. (@fs=44.1, 48 kHz)

## Digital Input Spec

Input		Format	Data length	Level	Connector
2TR IN DIGITAL	1	AES/EBU	24-bit	RS422	XLR-3-31 type (Balanced) <sup>1</sup>
	2	IEC-60958	24-bit	0.5 Vpp/75 Ω	Phono

1. XLR-3-31 type connectors are balanced (1=GND, 2=HOT, 3=COLD).

## Digital Output Spec

Output		Format	Data length	Level	Connector
2TR OUT DIGITAL	1	AES/EBU <sup>1</sup> Professional use	24-bit <sup>2</sup>	RS422	XLR-3-32 type (Balanced) <sup>3</sup>
	2	IEC-60958 <sup>4</sup> Consumer use	24-bit <sup>2</sup>	0.5V pp/75 Ω	Phono

1. Channel status of 2TR OUT DIGITAL 1  
 Type: linear PCM  
 Emphasis: NO  
 Sampling rate: depends on the internal configuration
2. Dither: word length 16/20/24 bit
3. XLR-3-32 type connectors are balanced (1=GND, 2=HOT, 3=COLD).
4. Channel status of 2TR OUT DIGITAL 2  
 Type: linear PCM  
 Category code: Digital signal mixer  
 Copy prohibit: NO  
 Emphasis: NO  
 Clock accuracy: Level II (1000 ppm)  
 Sampling rate: depends on the internal configuration

## I/O Slot Spec (1–2)

Each I/O SLOT accepts a digital interface card. SLOT #1 has a serial interface.

Maker	Model	Function	INPUT	OUTPUT 1	Format	Resolution	Frequency	The number of Available cards	Note
Yamaha	MY8-AT	Digital I/O	8	8	ADAT	24 bit	44.1/48 kHz	2	Can handle 24 bit/96 kHz by double channel mode
	MY16-AT	Digital I/O	16	16	ADAT	24 bit	44.1/48 kHz	2	Can handle 24 bit/96 kHz by double channel mode
	MY8-TD	Digital I/O	8	8	TASCAM	24 bit	44.1/48 kHz	2	Can handle 24 bit/96 kHz by double channel mode
	MY8-AE	Digital I/O	8	8	AES/EBU	24 bit	44.1/48 kHz	2	Can handle 24 bit/96 kHz by double channel mode
	MY8-AE96S	Digital I/O	8	8	AES/EBU	24 bit	44.1/48/88.2/96 kHz	2	Sampling Rate Converter for input
	MY8-AE96	Digital I/O	8	8	AES/EBU	24 bit	44.1/48/88.2/96 kHz	2	
	MY4-AD	ANALOG IN	4	—	—	24 bit	44.1/48 kHz	2	
	MY8-AD	ANALOG IN	8	—	—	20 bit	44.1/48 kHz	2	
	MY8-AD24	ANALOG IN	8	—	—	24 bit	44.1/48 kHz	2	
	MY8-AD96	ANALOG IN	8	—	—	24 bit	44.1/48/88.2/96 kHz	2	
	MY4-DA	ANALOG OUT	—	4	—	20 bit	44.1/48 kHz	2	
	MY8-DA96	ANALOG OUT	—	8	—	24 bit	44.1/48/88.2/96 kHz	2	
	MY8-mLAN	mLAN Interface	8	8	IEEE1394	24 bit	44.1/48 kHz	2	Maximum 5 nodes
Waves	Y56K	Effect & I/O	8	8	ADAT	24 bit	44.1/48 kHz	1	
Apogee	AP8AD	ANALOG IN	8	—	—	24 bit	44.1/48/88.2/96 kHz	2	4ch @fs=88.2, 96 kHz
	AP8DA	ANALOG OUT	—	8	—	24 bit	44.1/48/88.2/96 kHz	2	4ch @fs=88.2, 96 kHz

1. Selectable from STEREO/BUS/AUX/DIRECT/EXT INSERT/SURROUND MONITOR/CR MONITOR. Details depend on each interface card.

## Control I/O Spec

I/O Port		Format	Level	Connector in Console
TO HOST USB		USB	0 V–3.3 V	B type USB connector
MIDI	IN <sup>1</sup>	MIDI	—	DIN Connector 5P
	OUT	MIDI	—	DIN Connector 5P
TIME CODE INPUT		SMPTE	Nominal –10 dB/10k Ω	XLR-3-31 type (Balanced) <sup>2</sup>
WORD CLOCK	IN	—	TTL/75 Ω	BNC Connector
	OUT	—	TTL/75 Ω	BNC Connector
CONTROL		—	C-MOS IN, Open collector OUT 1pin: 150 mA, 8pin total: 500 mA	D-SUB Connector 25P (Female)
REMOTE		—	RS422	D-SUB Connector 9P (Male)
METER		—	RS422	D-SUB Connector 15P (Female)

1. MIDI IN can use as TIME CODE IN MTC.
2. XLR-3-31 type connectors are balanced (1=GND, 2=HOT, 3=COLD).

## REMOTE Port

Pin	Signal	Pin	Signal
1	GND	6	RX+/GND <sup>1</sup>
2	RX-/RX- <sup>1</sup>	7	RTS/RX+ <sup>1</sup>
3	TX-/TX+ <sup>1</sup>	8	CTS/TX- <sup>1</sup>
4	TX+/GND <sup>1</sup>	9	GND
5	N.C.		

1. RS422 (for AD824)/SONY 9 pin protocol (P2)

## CONTROL Port

Pin	Signal	Pin	Signal
1	GPO0	14	GPO1
2	GPO2	15	GPO3
3	GPO4	16	GPO5
4	GPO6	17	GPO7
5	GND	18	GND
6	GND	19	GND
7	GND	20	GND
8	GND	21	+5V
9	+5V	22	GPI0
10	GPI1	23	GPI2
11	GPI3	24	N.C.
12	N.C.	25	N.C.
13	N.C.		

## Dimensions

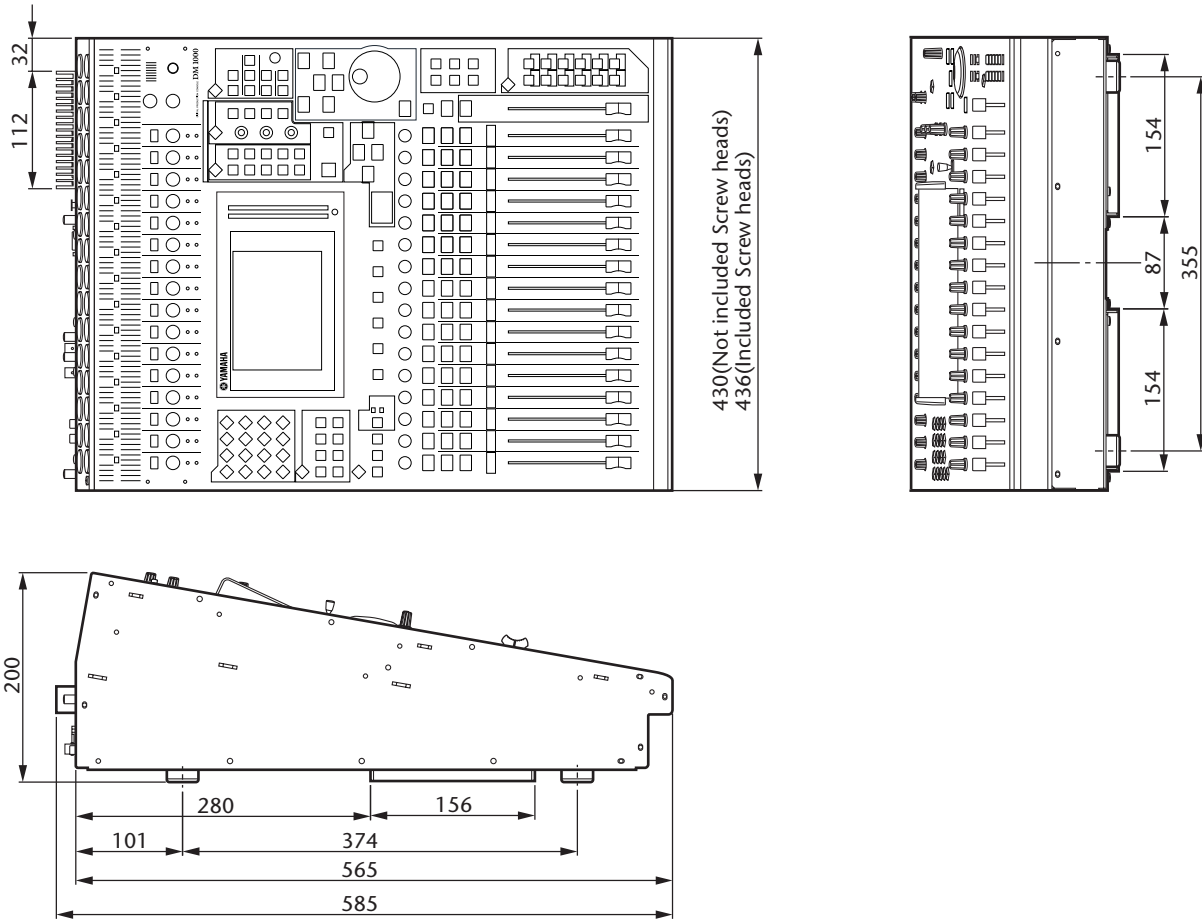

Unit: mm

### Dimensions with the MB1000 and SP1000 installed:

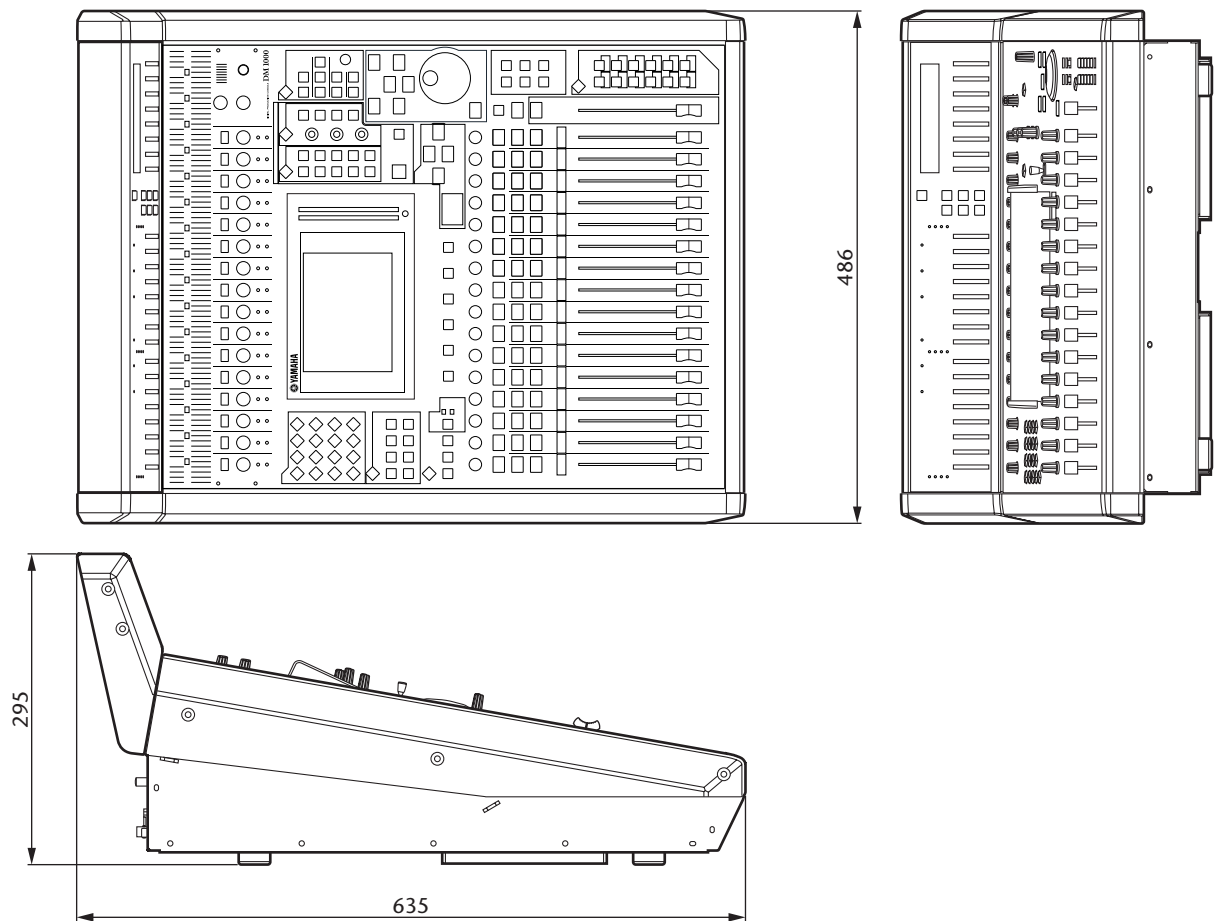

Unit: mm

Specifications and descriptions in this owner's manual are for information purposes only. Yamaha Corp. reserves the right to change or modify products or specifications at any time without prior notice. Since specifications, equipment or options may not be the same in every locale, please check with your Yamaha dealer.

#### European Models

Purchaser/User Information specified in EN55103-1 and EN55103-2.

Inrush Current: 28 A

Conforms to Environments: E1, E2, E3 and E4

# Appendix C: MIDI

## Scene Memory to Program Change Table

Program Change #	Initial Scene #	User Scene #
1	01	
2	02	
3	03	
4	04	
5	05	
6	06	
7	07	
8	08	
9	09	
10	10	
11	11	
12	12	
13	13	
14	14	
15	15	
16	16	
17	17	
18	18	
19	19	
20	20	
21	21	
22	22	
23	23	
24	24	
25	25	
26	26	
27	27	
28	28	
29	29	
30	30	
31	31	
32	32	
33	33	
34	34	
35	35	
36	36	
37	37	
38	38	
39	39	
40	40	
41	41	
42	42	
43	43	

Program Change #	Initial Scene #	User Scene #
44	44	
45	45	
46	46	
47	47	
48	48	
49	49	
50	50	
51	51	
52	52	
53	53	
54	54	
55	55	
56	56	
57	57	
58	58	
59	59	
60	60	
61	61	
62	62	
63	63	
64	64	
65	65	
66	66	
67	67	
68	68	
69	69	
70	70	
71	71	
72	72	
73	73	
74	74	
75	75	
76	76	
77	77	
78	78	
79	79	
80	80	
81	81	
82	82	
83	83	
84	84	
85	85	
86	86	

Program Change#	Initial Scene #	User Scene #
87	87	
88	88	
89	89	
90	90	
91	91	
92	92	
93	93	
94	94	
95	95	
96	96	
97	97	
98	98	
99	99	
100	00	
101	—	
102	—	
103	—	
104	—	
105	—	
106	—	
107	—	
108	—	
109	—	
110	—	
111	—	
112	—	
113	—	
114	—	
115	—	
116	—	
117	—	
118	—	
119	—	
120	—	
121	—	
122	—	
123	—	
124	—	
125	—	
126	—	
127	—	
128	—	



## Initial Parameter to Control Change Table

### CHANNEL1

#	High	Mid	Low
0	NO ASSIGN		
1	FADER H	CHANNEL	INPUT1
2	FADER H	CHANNEL	INPUT2
3	FADER H	CHANNEL	INPUT3
4	FADER H	CHANNEL	INPUT4
5	FADER H	CHANNEL	INPUT5
6	FADER H	CHANNEL	INPUT6
7	FADER H	CHANNEL	INPUT7
8	FADER H	CHANNEL	INPUT8
9	FADER H	CHANNEL	INPUT9
10	FADER H	CHANNEL	INPUT10
11	FADER H	CHANNEL	INPUT11
12	FADER H	CHANNEL	INPUT12
13	FADER H	CHANNEL	INPUT13
14	FADER H	CHANNEL	INPUT14
15	FADER H	CHANNEL	INPUT15
16	FADER H	CHANNEL	INPUT16
17	FADER H	CHANNEL	INPUT17
18	FADER H	CHANNEL	INPUT18
19	FADER H	CHANNEL	INPUT19
20	FADER H	CHANNEL	INPUT20
21	FADER H	CHANNEL	INPUT21
22	FADER H	CHANNEL	INPUT22
23	FADER H	CHANNEL	INPUT23
24	FADER H	CHANNEL	INPUT24
25	FADER H	MASTER	BUS1
26	FADER H	MASTER	BUS2
27	FADER H	MASTER	BUS3
28	FADER H	MASTER	BUS4
29	NO ASSIGN		
30	FADER H	MASTER	STEREO
31	NO ASSIGN		
32	NO ASSIGN		
33	FADER L	CHANNEL	INPUT1
34	FADER L	CHANNEL	INPUT2
35	FADER L	CHANNEL	INPUT3
36	FADER L	CHANNEL	INPUT4
37	FADER L	CHANNEL	INPUT5
38	FADER L	CHANNEL	INPUT6
39	FADER L	CHANNEL	INPUT7
40	FADER L	CHANNEL	INPUT8
41	FADER L	CHANNEL	INPUT9
42	FADER L	CHANNEL	INPUT10
43	FADER L	CHANNEL	INPUT11
44	FADER L	CHANNEL	INPUT12
45	FADER L	CHANNEL	INPUT13
46	FADER L	CHANNEL	INPUT14
47	FADER L	CHANNEL	INPUT15
48	FADER L	CHANNEL	INPUT16
49	FADER L	CHANNEL	INPUT17
50	FADER L	CHANNEL	INPUT18
51	FADER L	CHANNEL	INPUT19
52	FADER L	CHANNEL	INPUT20
53	FADER L	CHANNEL	INPUT21
54	FADER L	CHANNEL	INPUT22
55	FADER L	CHANNEL	INPUT23
56	FADER L	CHANNEL	INPUT24

#	High	Mid	Low
57	FADER L	MASTER	BUS1
58	FADER L	MASTER	BUS2
59	FADER L	MASTER	BUS3
60	FADER L	MASTER	BUS4
61	NO ASSIGN		
62	FADER L	MASTER	STEREO
63	NO ASSIGN		
64	ON	CHANNEL	INPUT1
65	ON	CHANNEL	INPUT2
66	ON	CHANNEL	INPUT3
67	ON	CHANNEL	INPUT4
68	ON	CHANNEL	INPUT5
69	ON	CHANNEL	INPUT6
70	ON	CHANNEL	INPUT7
71	ON	CHANNEL	INPUT8
72	ON	CHANNEL	INPUT9
73	ON	CHANNEL	INPUT10
74	ON	CHANNEL	INPUT11
75	ON	CHANNEL	INPUT12
76	ON	CHANNEL	INPUT13
77	ON	CHANNEL	INPUT14
78	ON	CHANNEL	INPUT15
79	ON	CHANNEL	INPUT16
80	ON	CHANNEL	INPUT17
81	ON	CHANNEL	INPUT18
82	ON	CHANNEL	INPUT19
83	ON	CHANNEL	INPUT20
84	ON	CHANNEL	INPUT21
85	ON	CHANNEL	INPUT22
86	ON	CHANNEL	INPUT23
87	ON	CHANNEL	INPUT24
88	NO ASSIGN		
89	PAN	CHANNEL	INPUT1
90	PAN	CHANNEL	INPUT2
91	PAN	CHANNEL	INPUT3
92	PAN	CHANNEL	INPUT4
93	PAN	CHANNEL	INPUT5
94	PAN	CHANNEL	INPUT6
95	PAN	CHANNEL	INPUT7
102	PAN	CHANNEL	INPUT8
103	PAN	CHANNEL	INPUT9
104	PAN	CHANNEL	INPUT10
105	PAN	CHANNEL	INPUT11
106	PAN	CHANNEL	INPUT12
107	PAN	CHANNEL	INPUT13
108	PAN	CHANNEL	INPUT14
109	PAN	CHANNEL	INPUT15
110	PAN	CHANNEL	INPUT16
111	PAN	CHANNEL	INPUT17
112	PAN	CHANNEL	INPUT18
113	PAN	CHANNEL	INPUT19
114	PAN	CHANNEL	INPUT20
115	PAN	CHANNEL	INPUT21
116	PAN	CHANNEL	INPUT22
117	PAN	CHANNEL	INPUT23
118	PAN	CHANNEL	INPUT24
119	NO ASSIGN		

## CHANNEL2

#	High	Mid	Low
0	NO ASSIGN		
1	FADER H	CHANNEL	INPUT25
2	FADER H	CHANNEL	INPUT26
3	FADER H	CHANNEL	INPUT27
4	FADER H	CHANNEL	INPUT28
5	FADER H	CHANNEL	INPUT29
6	FADER H	CHANNEL	INPUT30
7	FADER H	CHANNEL	INPUT31
8	FADER H	CHANNEL	INPUT32
9	FADER H	CHANNEL	INPUT33
10	FADER H	CHANNEL	INPUT34
11	FADER H	CHANNEL	INPUT35
12	FADER H	CHANNEL	INPUT36
13	FADER H	CHANNEL	INPUT37
14	FADER H	CHANNEL	INPUT38
15	FADER H	CHANNEL	INPUT39
16	FADER H	CHANNEL	INPUT40
17	FADER H	CHANNEL	INPUT41
18	FADER H	CHANNEL	INPUT42
19	FADER H	CHANNEL	INPUT43
20	FADER H	CHANNEL	INPUT44
21	FADER H	CHANNEL	INPUT45
22	FADER H	CHANNEL	INPUT46
23	FADER H	CHANNEL	INPUT47
24	FADER H	CHANNEL	INPUT48
25	FADER H	MASTER	BUS5
26	FADER H	MASTER	BUS6
27	FADER H	MASTER	BUS7
28	FADER H	MASTER	BUS8
29	NO ASSIGN		
30	ON	MASTER	STEREO
31	NO ASSIGN		
32	NO ASSIGN		
33	FADER L	CHANNEL	INPUT25
34	FADER L	CHANNEL	INPUT26
35	FADER L	CHANNEL	INPUT27
36	FADER L	CHANNEL	INPUT28
37	FADER L	CHANNEL	INPUT29
38	FADER L	CHANNEL	INPUT30
39	FADER L	CHANNEL	INPUT31
40	FADER L	CHANNEL	INPUT32
41	FADER L	CHANNEL	INPUT33
42	FADER L	CHANNEL	INPUT34
43	FADER L	CHANNEL	INPUT35
44	FADER L	CHANNEL	INPUT36
45	FADER L	CHANNEL	INPUT37
46	FADER L	CHANNEL	INPUT38
47	FADER L	CHANNEL	INPUT39
48	FADER L	CHANNEL	INPUT40
49	FADER L	CHANNEL	INPUT41
50	FADER L	CHANNEL	INPUT42
51	FADER L	CHANNEL	INPUT43
52	FADER L	CHANNEL	INPUT44
53	FADER L	CHANNEL	INPUT45
54	FADER L	CHANNEL	INPUT46
55	FADER L	CHANNEL	INPUT47
56	FADER L	CHANNEL	INPUT48
57	FADER L	MASTER	BUS5
58	FADER L	MASTER	BUS6

#	High	Mid	Low
59	FADER L	MASTER	BUS7
60	FADER L	MASTER	BUS8
61	NO ASSIGN		
62	BALANCE	MASTER	STEREO
63	NO ASSIGN		
64	ON	CHANNEL	INPUT25
65	ON	CHANNEL	INPUT26
66	ON	CHANNEL	INPUT27
67	ON	CHANNEL	INPUT28
68	ON	CHANNEL	INPUT29
69	ON	CHANNEL	INPUT30
70	ON	CHANNEL	INPUT31
71	ON	CHANNEL	INPUT32
72	ON	CHANNEL	INPUT33
73	ON	CHANNEL	INPUT34
74	ON	CHANNEL	INPUT35
75	ON	CHANNEL	INPUT36
76	ON	CHANNEL	INPUT37
77	ON	CHANNEL	INPUT38
78	ON	CHANNEL	INPUT39
79	ON	CHANNEL	INPUT40
80	ON	CHANNEL	INPUT41
81	ON	CHANNEL	INPUT42
82	ON	CHANNEL	INPUT43
83	ON	CHANNEL	INPUT44
84	ON	CHANNEL	INPUT45
85	ON	CHANNEL	INPUT46
86	ON	CHANNEL	INPUT47
87	ON	CHANNEL	INPUT48
88	NO ASSIGN		
89	PAN	CHANNEL	INPUT25
90	PAN	CHANNEL	INPUT26
91	PAN	CHANNEL	INPUT27
92	PAN	CHANNEL	INPUT28
93	PAN	CHANNEL	INPUT29
94	PAN	CHANNEL	INPUT30
95	PAN	CHANNEL	INPUT31
102	PAN	CHANNEL	INPUT32
103	PAN	CHANNEL	INPUT33
104	PAN	CHANNEL	INPUT34
105	PAN	CHANNEL	INPUT35
106	PAN	CHANNEL	INPUT36
107	PAN	CHANNEL	INPUT37
108	PAN	CHANNEL	INPUT38
109	PAN	CHANNEL	INPUT39
110	PAN	CHANNEL	INPUT40
111	PAN	CHANNEL	INPUT41
112	PAN	CHANNEL	INPUT42
113	PAN	CHANNEL	INPUT43
114	PAN	CHANNEL	INPUT44
115	PAN	CHANNEL	INPUT45
116	PAN	CHANNEL	INPUT46
117	PAN	CHANNEL	INPUT47
118	PAN	CHANNEL	INPUT48
119	NO ASSIGN		

## CHANNEL3

#	High	Mid	Low
0	NO ASSIGN		
1	EQ	G LOW H	INPUT1
2	EQ	G LOW H	INPUT2
3	EQ	G LOW H	INPUT3
4	EQ	G LOW H	INPUT4
5	EQ	G LOW H	INPUT5
6	EQ	G LOW H	INPUT6
7	EQ	G LOW H	INPUT7
8	EQ	G LOW H	INPUT8
9	EQ	G LOW H	INPUT9
10	EQ	G LOW H	INPUT10
11	EQ	G LOW H	INPUT11
12	EQ	G LOW H	INPUT12
13	EQ	G LOW H	INPUT13
14	EQ	G LOW H	INPUT14
15	EQ	G LOW H	INPUT15
16	EQ	G LOW H	INPUT16
17	EQ	G LOW H	INPUT17
18	EQ	G LOW H	INPUT18
19	EQ	G LOW H	INPUT19
20	EQ	G LOW H	INPUT20
21	EQ	G LOW H	INPUT21
22	EQ	G LOW H	INPUT22
23	EQ	G LOW H	INPUT23
24	EQ	G LOW H	INPUT24
25	FADER H	MASTER	AUX1
26	FADER H	MASTER	AUX2
27	FADER H	MASTER	AUX3
28	FADER H	MASTER	AUX4
29	NO ASSIGN		
30	NO ASSIGN		
31	NO ASSIGN		
32	NO ASSIGN		
33	EQ	G LOW L	INPUT1
34	EQ	G LOW L	INPUT2
35	EQ	G LOW L	INPUT3
36	EQ	G LOW L	INPUT4
37	EQ	G LOW L	INPUT5
38	EQ	G LOW L	INPUT6
39	EQ	G LOW L	INPUT7
40	EQ	G LOW L	INPUT8
41	EQ	G LOW L	INPUT9
42	EQ	G LOW L	INPUT10
43	EQ	G LOW L	INPUT11
44	EQ	G LOW L	INPUT12
45	EQ	G LOW L	INPUT13
46	EQ	G LOW L	INPUT14
47	EQ	G LOW L	INPUT15
48	EQ	G LOW L	INPUT16
49	EQ	G LOW L	INPUT17
50	EQ	G LOW L	INPUT18
51	EQ	G LOW L	INPUT19
52	EQ	G LOW L	INPUT20
53	EQ	G LOW L	INPUT21
54	EQ	G LOW L	INPUT22
55	EQ	G LOW L	INPUT23
56	EQ	G LOW L	INPUT24
57	FADER L	MASTER	AUX1
58	FADER L	MASTER	AUX2

#	High	Mid	Low
59	FADER L	MASTER	AUX3
60	FADER L	MASTER	AUX4
61	NO ASSIGN		
62	NO ASSIGN		
63	NO ASSIGN		
64	EQ	F LOW	INPUT1
65	EQ	F LOW	INPUT2
66	EQ	F LOW	INPUT3
67	EQ	F LOW	INPUT4
68	EQ	F LOW	INPUT5
69	EQ	F LOW	INPUT6
70	EQ	F LOW	INPUT7
71	EQ	F LOW	INPUT8
72	EQ	F LOW	INPUT9
73	EQ	F LOW	INPUT10
74	EQ	F LOW	INPUT11
75	EQ	F LOW	INPUT12
76	EQ	F LOW	INPUT13
77	EQ	F LOW	INPUT14
78	EQ	F LOW	INPUT15
79	EQ	F LOW	INPUT16
80	EQ	F LOW	INPUT17
81	EQ	F LOW	INPUT18
82	EQ	F LOW	INPUT19
83	EQ	F LOW	INPUT20
84	EQ	F LOW	INPUT21
85	EQ	F LOW	INPUT22
86	EQ	F LOW	INPUT23
87	EQ	F LOW	INPUT24
88	NO ASSIGN		
89	EQ	Q LOW	INPUT1
90	EQ	Q LOW	INPUT2
91	EQ	Q LOW	INPUT3
92	EQ	Q LOW	INPUT4
93	EQ	Q LOW	INPUT5
94	EQ	Q LOW	INPUT6
95	EQ	Q LOW	INPUT7
102	EQ	Q LOW	INPUT8
103	EQ	Q LOW	INPUT9
104	EQ	Q LOW	INPUT10
105	EQ	Q LOW	INPUT11
106	EQ	Q LOW	INPUT12
107	EQ	Q LOW	INPUT13
108	EQ	Q LOW	INPUT14
109	EQ	Q LOW	INPUT15
110	EQ	Q LOW	INPUT16
111	EQ	Q LOW	INPUT17
112	EQ	Q LOW	INPUT18
113	EQ	Q LOW	INPUT19
114	EQ	Q LOW	INPUT20
115	EQ	Q LOW	INPUT21
116	EQ	Q LOW	INPUT22
117	EQ	Q LOW	INPUT23
118	EQ	Q LOW	INPUT24
119	NO ASSIGN		

## CHANNEL 4

#	High	Mid	Low
0	NO ASSIGN		
1	EQ	G LOW H	INPUT25
2	EQ	G LOW H	INPUT26
3	EQ	G LOW H	INPUT27
4	EQ	G LOW H	INPUT28
5	EQ	G LOW H	INPUT29
6	EQ	G LOW H	INPUT30
7	EQ	G LOW H	INPUT31
8	EQ	G LOW H	INPUT32
9	EQ	G LOW H	INPUT33
10	EQ	G LOW H	INPUT34
11	EQ	G LOW H	INPUT35
12	EQ	G LOW H	INPUT36
13	EQ	G LOW H	INPUT37
14	EQ	G LOW H	INPUT38
15	EQ	G LOW H	INPUT39
16	EQ	G LOW H	INPUT40
17	EQ	G LOW H	INPUT41
18	EQ	G LOW H	INPUT42
19	EQ	G LOW H	INPUT43
20	EQ	G LOW H	INPUT44
21	EQ	G LOW H	INPUT45
22	EQ	G LOW H	INPUT46
23	EQ	G LOW H	INPUT47
24	EQ	G LOW H	INPUT48
25	FADER H	MASTER	AUX5
26	FADER H	MASTER	AUX6
27	FADER H	MASTER	AUX7
28	FADER H	MASTER	AUX8
29	NO ASSIGN		
30	NO ASSIGN		
31	NO ASSIGN		
32	NO ASSIGN		
33	EQ	G LOW L	INPUT25
34	EQ	G LOW L	INPUT26
35	EQ	G LOW L	INPUT27
36	EQ	G LOW L	INPUT28
37	EQ	G LOW L	INPUT29
38	EQ	G LOW L	INPUT30
39	EQ	G LOW L	INPUT31
40	EQ	G LOW L	INPUT32
41	EQ	G LOW L	INPUT33
42	EQ	G LOW L	INPUT34
43	EQ	G LOW L	INPUT35
44	EQ	G LOW L	INPUT36
45	EQ	G LOW L	INPUT37
46	EQ	G LOW L	INPUT38
47	EQ	G LOW L	INPUT39
48	EQ	G LOW L	INPUT40
49	EQ	G LOW L	INPUT41
50	EQ	G LOW L	INPUT42
51	EQ	G LOW L	INPUT43
52	EQ	G LOW L	INPUT44
53	EQ	G LOW L	INPUT45
54	EQ	G LOW L	INPUT46
55	EQ	G LOW L	INPUT47
56	EQ	G LOW L	INPUT48
57	FADER L	MASTER	AUX5
58	FADER L	MASTER	AUX6

#	High	Mid	Low
59	FADER L	MASTER	AUX7
60	FADER L	MASTER	AUX8
61	NO ASSIGN		
62	NO ASSIGN		
63	NO ASSIGN		
64	EQ	F LOW	INPUT25
65	EQ	F LOW	INPUT26
66	EQ	F LOW	INPUT27
67	EQ	F LOW	INPUT28
68	EQ	F LOW	INPUT29
69	EQ	F LOW	INPUT30
70	EQ	F LOW	INPUT31
71	EQ	F LOW	INPUT32
72	EQ	F LOW	INPUT33
73	EQ	F LOW	INPUT34
74	EQ	F LOW	INPUT35
75	EQ	F LOW	INPUT36
76	EQ	F LOW	INPUT37
77	EQ	F LOW	INPUT38
78	EQ	F LOW	INPUT39
79	EQ	F LOW	INPUT40
80	EQ	F LOW	INPUT41
81	EQ	F LOW	INPUT42
82	EQ	F LOW	INPUT43
83	EQ	F LOW	INPUT44
84	EQ	F LOW	INPUT45
85	EQ	F LOW	INPUT46
86	EQ	F LOW	INPUT47
87	EQ	F LOW	INPUT48
88	NO ASSIGN		
89	EQ	Q LOW	INPUT25
90	EQ	Q LOW	INPUT26
91	EQ	Q LOW	INPUT27
92	EQ	Q LOW	INPUT28
93	EQ	Q LOW	INPUT29
94	EQ	Q LOW	INPUT30
95	EQ	Q LOW	INPUT31
102	EQ	Q LOW	INPUT32
103	EQ	Q LOW	INPUT33
104	EQ	Q LOW	INPUT34
105	EQ	Q LOW	INPUT35
106	EQ	Q LOW	INPUT36
107	EQ	Q LOW	INPUT37
108	EQ	Q LOW	INPUT38
109	EQ	Q LOW	INPUT39
110	EQ	Q LOW	INPUT40
111	EQ	Q LOW	INPUT41
112	EQ	Q LOW	INPUT42
113	EQ	Q LOW	INPUT43
114	EQ	Q LOW	INPUT44
115	EQ	Q LOW	INPUT45
116	EQ	Q LOW	INPUT46
117	EQ	Q LOW	INPUT47
118	EQ	Q LOW	INPUT48
119	NO ASSIGN		

## CHANNELS

#	High	Mid	Low
0	NO ASSIGN		
1	EQ	G LO-MID H	INPUT1
2	EQ	G LO-MID H	INPUT2
3	EQ	G LO-MID H	INPUT3
4	EQ	G LO-MID H	INPUT4
5	EQ	G LO-MID H	INPUT5
6	EQ	G LO-MID H	INPUT6
7	EQ	G LO-MID H	INPUT7
8	EQ	G LO-MID H	INPUT8
9	EQ	G LO-MID H	INPUT9
10	EQ	G LO-MID H	INPUT10
11	EQ	G LO-MID H	INPUT11
12	EQ	G LO-MID H	INPUT12
13	EQ	G LO-MID H	INPUT13
14	EQ	G LO-MID H	INPUT14
15	EQ	G LO-MID H	INPUT15
16	EQ	G LO-MID H	INPUT16
17	EQ	G LO-MID H	INPUT17
18	EQ	G LO-MID H	INPUT18
19	EQ	G LO-MID H	INPUT19
20	EQ	G LO-MID H	INPUT20
21	EQ	G LO-MID H	INPUT21
22	EQ	G LO-MID H	INPUT22
23	EQ	G LO-MID H	INPUT23
24	EQ	G LO-MID H	INPUT24
25	ON	MASTER	BUS1
26	ON	MASTER	BUS2
27	ON	MASTER	BUS3
28	ON	MASTER	BUS4
29	NO ASSIGN		
30	NO ASSIGN		
31	NO ASSIGN		
32	NO ASSIGN		
33	EQ	G LO-MID L	INPUT1
34	EQ	G LO-MID L	INPUT2
35	EQ	G LO-MID L	INPUT3
36	EQ	G LO-MID L	INPUT4
37	EQ	G LO-MID L	INPUT5
38	EQ	G LO-MID L	INPUT6
39	EQ	G LO-MID L	INPUT7
40	EQ	G LO-MID L	INPUT8
41	EQ	G LO-MID L	INPUT9
42	EQ	G LO-MID L	INPUT10
43	EQ	G LO-MID L	INPUT11
44	EQ	G LO-MID L	INPUT12
45	EQ	G LO-MID L	INPUT13
46	EQ	G LO-MID L	INPUT14
47	EQ	G LO-MID L	INPUT15
48	EQ	G LO-MID L	INPUT16
49	EQ	G LO-MID L	INPUT17
50	EQ	G LO-MID L	INPUT18
51	EQ	G LO-MID L	INPUT19
52	EQ	G LO-MID L	INPUT20
53	EQ	G LO-MID L	INPUT21
54	EQ	G LO-MID L	INPUT22
55	EQ	G LO-MID L	INPUT23
56	EQ	G LO-MID L	INPUT24
57	ON	MASTER	BUS5
58	ON	MASTER	BUS6

#	High	Mid	Low
59	ON	MASTER	BUS7
60	ON	MASTER	BUS8
61	NO ASSIGN		
62	NO ASSIGN		
63	NO ASSIGN		
64	EQ	F LO-MID	INPUT1
65	EQ	F LO-MID	INPUT2
66	EQ	F LO-MID	INPUT3
67	EQ	F LO-MID	INPUT4
68	EQ	F LO-MID	INPUT5
69	EQ	F LO-MID	INPUT6
70	EQ	F LO-MID	INPUT7
71	EQ	F LO-MID	INPUT8
72	EQ	F LO-MID	INPUT9
73	EQ	F LO-MID	INPUT10
74	EQ	F LO-MID	INPUT11
75	EQ	F LO-MID	INPUT12
76	EQ	F LO-MID	INPUT13
77	EQ	F LO-MID	INPUT14
78	EQ	F LO-MID	INPUT15
79	EQ	F LO-MID	INPUT16
80	EQ	F LO-MID	INPUT17
81	EQ	F LO-MID	INPUT18
82	EQ	F LO-MID	INPUT19
83	EQ	F LO-MID	INPUT20
84	EQ	F LO-MID	INPUT21
85	EQ	F LO-MID	INPUT22
86	EQ	F LO-MID	INPUT23
87	EQ	F LO-MID	INPUT24
88	NO ASSIGN		
89	EQ	Q LO-MID	INPUT1
90	EQ	Q LO-MID	INPUT2
91	EQ	Q LO-MID	INPUT3
92	EQ	Q LO-MID	INPUT4
93	EQ	Q LO-MID	INPUT5
94	EQ	Q LO-MID	INPUT6
95	EQ	Q LO-MID	INPUT7
102	EQ	Q LO-MID	INPUT8
103	EQ	Q LO-MID	INPUT9
104	EQ	Q LO-MID	INPUT10
105	EQ	Q LO-MID	INPUT11
106	EQ	Q LO-MID	INPUT12
107	EQ	Q LO-MID	INPUT13
108	EQ	Q LO-MID	INPUT14
109	EQ	Q LO-MID	INPUT15
110	EQ	Q LO-MID	INPUT16
111	EQ	Q LO-MID	INPUT17
112	EQ	Q LO-MID	INPUT18
113	EQ	Q LO-MID	INPUT19
114	EQ	Q LO-MID	INPUT20
115	EQ	Q LO-MID	INPUT21
116	EQ	Q LO-MID	INPUT22
117	EQ	Q LO-MID	INPUT23
118	EQ	Q LO-MID	INPUT24
119	NO ASSIGN		

## CHANNEL 6

#	High	Mid	Low
0	NO ASSIGN		
1	EQ	G LO-MID H	INPUT25
2	EQ	G LO-MID H	INPUT26
3	EQ	G LO-MID H	INPUT27
4	EQ	G LO-MID H	INPUT28
5	EQ	G LO-MID H	INPUT29
6	EQ	G LO-MID H	INPUT30
7	EQ	G LO-MID H	INPUT31
8	EQ	G LO-MID H	INPUT32
9	EQ	G LO-MID H	INPUT33
10	EQ	G LO-MID H	INPUT34
11	EQ	G LO-MID H	INPUT35
12	EQ	G LO-MID H	INPUT36
13	EQ	G LO-MID H	INPUT37
14	EQ	G LO-MID H	INPUT38
15	EQ	G LO-MID H	INPUT39
16	EQ	G LO-MID H	INPUT40
17	EQ	G LO-MID H	INPUT41
18	EQ	G LO-MID H	INPUT42
19	EQ	G LO-MID H	INPUT43
20	EQ	G LO-MID H	INPUT44
21	EQ	G LO-MID H	INPUT45
22	EQ	G LO-MID H	INPUT46
23	EQ	G LO-MID H	INPUT47
24	EQ	G LO-MID H	INPUT48
25	ON	MASTER	AUX1
26	ON	MASTER	AUX2
27	ON	MASTER	AUX3
28	ON	MASTER	AUX4
29	NO ASSIGN		
30	NO ASSIGN		
31	NO ASSIGN		
32	NO ASSIGN		
33	EQ	G LO-MID L	INPUT25
34	EQ	G LO-MID L	INPUT26
35	EQ	G LO-MID L	INPUT27
36	EQ	G LO-MID L	INPUT28
37	EQ	G LO-MID L	INPUT29
38	EQ	G LO-MID L	INPUT30
39	EQ	G LO-MID L	INPUT31
40	EQ	G LO-MID L	INPUT32
41	EQ	G LO-MID L	INPUT33
42	EQ	G LO-MID L	INPUT34
43	EQ	G LO-MID L	INPUT35
44	EQ	G LO-MID L	INPUT36
45	EQ	G LO-MID L	INPUT37
46	EQ	G LO-MID L	INPUT38
47	EQ	G LO-MID L	INPUT39
48	EQ	G LO-MID L	INPUT40
49	EQ	G LO-MID L	INPUT41
50	EQ	G LO-MID L	INPUT42
51	EQ	G LO-MID L	INPUT43
52	EQ	G LO-MID L	INPUT44
53	EQ	G LO-MID L	INPUT45
54	EQ	G LO-MID L	INPUT46
55	EQ	G LO-MID L	INPUT47
56	EQ	G LO-MID L	INPUT48
57	ON	MASTER	AUX5
58	ON	MASTER	AUX6

#	High	Mid	Low
59	ON	MASTER	AUX7
60	ON	MASTER	AUX8
61	NO ASSIGN		
62	NO ASSIGN		
63	NO ASSIGN		
64	EQ	F LO-MID	INPUT25
65	EQ	F LO-MID	INPUT26
66	EQ	F LO-MID	INPUT27
67	EQ	F LO-MID	INPUT28
68	EQ	F LO-MID	INPUT29
69	EQ	F LO-MID	INPUT30
70	EQ	F LO-MID	INPUT31
71	EQ	F LO-MID	INPUT32
72	EQ	F LO-MID	INPUT33
73	EQ	F LO-MID	INPUT34
74	EQ	F LO-MID	INPUT35
75	EQ	F LO-MID	INPUT36
76	EQ	F LO-MID	INPUT37
77	EQ	F LO-MID	INPUT38
78	EQ	F LO-MID	INPUT39
79	EQ	F LO-MID	INPUT40
80	EQ	F LO-MID	INPUT41
81	EQ	F LO-MID	INPUT42
82	EQ	F LO-MID	INPUT43
83	EQ	F LO-MID	INPUT44
84	EQ	F LO-MID	INPUT45
85	EQ	F LO-MID	INPUT46
86	EQ	F LO-MID	INPUT47
87	EQ	F LO-MID	INPUT48
88	NO ASSIGN		
89	EQ	Q LO-MID	INPUT25
90	EQ	Q LO-MID	INPUT26
91	EQ	Q LO-MID	INPUT27
92	EQ	Q LO-MID	INPUT28
93	EQ	Q LO-MID	INPUT29
94	EQ	Q LO-MID	INPUT30
95	EQ	Q LO-MID	INPUT31
102	EQ	Q LO-MID	INPUT32
103	EQ	Q LO-MID	INPUT33
104	EQ	Q LO-MID	INPUT34
105	EQ	Q LO-MID	INPUT35
106	EQ	Q LO-MID	INPUT36
107	EQ	Q LO-MID	INPUT37
108	EQ	Q LO-MID	INPUT38
109	EQ	Q LO-MID	INPUT39
110	EQ	Q LO-MID	INPUT40
111	EQ	Q LO-MID	INPUT41
112	EQ	Q LO-MID	INPUT42
113	EQ	Q LO-MID	INPUT43
114	EQ	Q LO-MID	INPUT44
115	EQ	Q LO-MID	INPUT45
116	EQ	Q LO-MID	INPUT46
117	EQ	Q LO-MID	INPUT47
118	EQ	Q LO-MID	INPUT48
119	NO ASSIGN		

## CHANNEL7

#	High	Mid	Low
0	NO ASSIGN		
1	EQ	G HI-MID H	INPUT1
2	EQ	G HI-MID H	INPUT2
3	EQ	G HI-MID H	INPUT3
4	EQ	G HI-MID H	INPUT4
5	EQ	G HI-MID H	INPUT5
6	EQ	G HI-MID H	INPUT6
7	EQ	G HI-MID H	INPUT7
8	EQ	G HI-MID H	INPUT8
9	EQ	G HI-MID H	INPUT9
10	EQ	G HI-MID H	INPUT10
11	EQ	G HI-MID H	INPUT11
12	EQ	G HI-MID H	INPUT12
13	EQ	G HI-MID H	INPUT13
14	EQ	G HI-MID H	INPUT14
15	EQ	G HI-MID H	INPUT15
16	EQ	G HI-MID H	INPUT16
17	EQ	G HI-MID H	INPUT17
18	EQ	G HI-MID H	INPUT18
19	EQ	G HI-MID H	INPUT19
20	EQ	G HI-MID H	INPUT20
21	EQ	G HI-MID H	INPUT21
22	EQ	G HI-MID H	INPUT22
23	EQ	G HI-MID H	INPUT23
24	EQ	G HI-MID H	INPUT24
25	NO ASSIGN		
26	NO ASSIGN		
27	NO ASSIGN		
28	NO ASSIGN		
29	NO ASSIGN		
30	NO ASSIGN		
31	NO ASSIGN		
32	NO ASSIGN		
33	EQ	G HI-MID L	INPUT1
34	EQ	G HI-MID L	INPUT2
35	EQ	G HI-MID L	INPUT3
36	EQ	G HI-MID L	INPUT4
37	EQ	G HI-MID L	INPUT5
38	EQ	G HI-MID L	INPUT6
39	EQ	G HI-MID L	INPUT7
40	EQ	G HI-MID L	INPUT8
41	EQ	G HI-MID L	INPUT9
42	EQ	G HI-MID L	INPUT10
43	EQ	G HI-MID L	INPUT11
44	EQ	G HI-MID L	INPUT12
45	EQ	G HI-MID L	INPUT13
46	EQ	G HI-MID L	INPUT14
47	EQ	G HI-MID L	INPUT15
48	EQ	G HI-MID L	INPUT16
49	EQ	G HI-MID L	INPUT17
50	EQ	G HI-MID L	INPUT18
51	EQ	G HI-MID L	INPUT19
52	EQ	G HI-MID L	INPUT20
53	EQ	G HI-MID L	INPUT21
54	EQ	G HI-MID L	INPUT22
55	EQ	G HI-MID L	INPUT23
56	EQ	G HI-MID L	INPUT24
57	NO ASSIGN		
58	NO ASSIGN		

#	High	Mid	Low
59	NO ASSIGN		
60	NO ASSIGN		
61	NO ASSIGN		
62	NO ASSIGN		
63	NO ASSIGN		
64	EQ	F HI-MID	INPUT1
65	EQ	F HI-MID	INPUT2
66	EQ	F HI-MID	INPUT3
67	EQ	F HI-MID	INPUT4
68	EQ	F HI-MID	INPUT5
69	EQ	F HI-MID	INPUT6
70	EQ	F HI-MID	INPUT7
71	EQ	F HI-MID	INPUT8
72	EQ	F HI-MID	INPUT9
73	EQ	F HI-MID	INPUT10
74	EQ	F HI-MID	INPUT11
75	EQ	F HI-MID	INPUT12
76	EQ	F HI-MID	INPUT13
77	EQ	F HI-MID	INPUT14
78	EQ	F HI-MID	INPUT15
79	EQ	F HI-MID	INPUT16
80	EQ	F HI-MID	INPUT17
81	EQ	F HI-MID	INPUT18
82	EQ	F HI-MID	INPUT19
83	EQ	F HI-MID	INPUT20
84	EQ	F HI-MID	INPUT21
85	EQ	F HI-MID	INPUT22
86	EQ	F HI-MID	INPUT23
87	EQ	F HI-MID	INPUT24
88	NO ASSIGN		
89	EQ	Q HI-MID	INPUT1
90	EQ	Q HI-MID	INPUT2
91	EQ	Q HI-MID	INPUT3
92	EQ	Q HI-MID	INPUT4
93	EQ	Q HI-MID	INPUT5
94	EQ	Q HI-MID	INPUT6
95	EQ	Q HI-MID	INPUT7
102	EQ	Q HI-MID	INPUT8
103	EQ	Q HI-MID	INPUT9
104	EQ	Q HI-MID	INPUT10
105	EQ	Q HI-MID	INPUT11
106	EQ	Q HI-MID	INPUT12
107	EQ	Q HI-MID	INPUT13
108	EQ	Q HI-MID	INPUT14
109	EQ	Q HI-MID	INPUT15
110	EQ	Q HI-MID	INPUT16
111	EQ	Q HI-MID	INPUT17
112	EQ	Q HI-MID	INPUT18
113	EQ	Q HI-MID	INPUT19
114	EQ	Q HI-MID	INPUT20
115	EQ	Q HI-MID	INPUT21
116	EQ	Q HI-MID	INPUT22
117	EQ	Q HI-MID	INPUT23
118	EQ	Q HI-MID	INPUT24
119	NO ASSIGN		

## CHANNEL 8

#	High	Mid	Low
0	NO ASSIGN		
1	EQ	G HI-MID H	INPUT25
2	EQ	G HI-MID H	INPUT26
3	EQ	G HI-MID H	INPUT27
4	EQ	G HI-MID H	INPUT28
5	EQ	G HI-MID H	INPUT29
6	EQ	G HI-MID H	INPUT30
7	EQ	G HI-MID H	INPUT31
8	EQ	G HI-MID H	INPUT32
9	EQ	G HI-MID H	INPUT33
10	EQ	G HI-MID H	INPUT34
11	EQ	G HI-MID H	INPUT35
12	EQ	G HI-MID H	INPUT36
13	EQ	G HI-MID H	INPUT37
14	EQ	G HI-MID H	INPUT38
15	EQ	G HI-MID H	INPUT39
16	EQ	G HI-MID H	INPUT40
17	EQ	G HI-MID H	INPUT41
18	EQ	G HI-MID H	INPUT42
19	EQ	G HI-MID H	INPUT43
20	EQ	G HI-MID H	INPUT44
21	EQ	G HI-MID H	INPUT45
22	EQ	G HI-MID H	INPUT46
23	EQ	G HI-MID H	INPUT47
24	EQ	G HI-MID H	INPUT48
25	NO ASSIGN		
26	NO ASSIGN		
27	NO ASSIGN		
28	NO ASSIGN		
29	NO ASSIGN		
30	NO ASSIGN		
31	NO ASSIGN		
32	NO ASSIGN		
33	EQ	G HI-MID L	INPUT25
34	EQ	G HI-MID L	INPUT26
35	EQ	G HI-MID L	INPUT27
36	EQ	G HI-MID L	INPUT28
37	EQ	G HI-MID L	INPUT29
38	EQ	G HI-MID L	INPUT30
39	EQ	G HI-MID L	INPUT31
40	EQ	G HI-MID L	INPUT32
41	EQ	G HI-MID L	INPUT33
42	EQ	G HI-MID L	INPUT34
43	EQ	G HI-MID L	INPUT35
44	EQ	G HI-MID L	INPUT36
45	EQ	G HI-MID L	INPUT37
46	EQ	G HI-MID L	INPUT38
47	EQ	G HI-MID L	INPUT39
48	EQ	G HI-MID L	INPUT40
49	EQ	G HI-MID L	INPUT41
50	EQ	G HI-MID L	INPUT42
51	EQ	G HI-MID L	INPUT43
52	EQ	G HI-MID L	INPUT44
53	EQ	G HI-MID L	INPUT45
54	EQ	G HI-MID L	INPUT46
55	EQ	G HI-MID L	INPUT47
56	EQ	G HI-MID L	INPUT48
57	NO ASSIGN		
58	NO ASSIGN		

#	High	Mid	Low
59	NO ASSIGN		
60	NO ASSIGN		
61	NO ASSIGN		
62	NO ASSIGN		
63	NO ASSIGN		
64	EQ	F HI-MID	INPUT25
65	EQ	F HI-MID	INPUT26
66	EQ	F HI-MID	INPUT27
67	EQ	F HI-MID	INPUT28
68	EQ	F HI-MID	INPUT29
69	EQ	F HI-MID	INPUT30
70	EQ	F HI-MID	INPUT31
71	EQ	F HI-MID	INPUT32
72	EQ	F HI-MID	INPUT33
73	EQ	F HI-MID	INPUT34
74	EQ	F HI-MID	INPUT35
75	EQ	F HI-MID	INPUT36
76	EQ	F HI-MID	INPUT37
77	EQ	F HI-MID	INPUT38
78	EQ	F HI-MID	INPUT39
79	EQ	F HI-MID	INPUT40
80	EQ	F HI-MID	INPUT41
81	EQ	F HI-MID	INPUT42
82	EQ	F HI-MID	INPUT43
83	EQ	F HI-MID	INPUT44
84	EQ	F HI-MID	INPUT45
85	EQ	F HI-MID	INPUT46
86	EQ	F HI-MID	INPUT47
87	EQ	F HI-MID	INPUT48
88	NO ASSIGN		
89	EQ	Q HI-MID	INPUT25
90	EQ	Q HI-MID	INPUT26
91	EQ	Q HI-MID	INPUT27
92	EQ	Q HI-MID	INPUT28
93	EQ	Q HI-MID	INPUT29
94	EQ	Q HI-MID	INPUT30
95	EQ	Q HI-MID	INPUT31
102	EQ	Q HI-MID	INPUT32
103	EQ	Q HI-MID	INPUT33
104	EQ	Q HI-MID	INPUT34
105	EQ	Q HI-MID	INPUT35
106	EQ	Q HI-MID	INPUT36
107	EQ	Q HI-MID	INPUT37
108	EQ	Q HI-MID	INPUT38
109	EQ	Q HI-MID	INPUT39
110	EQ	Q HI-MID	INPUT40
111	EQ	Q HI-MID	INPUT41
112	EQ	Q HI-MID	INPUT42
113	EQ	Q HI-MID	INPUT43
114	EQ	Q HI-MID	INPUT44
115	EQ	Q HI-MID	INPUT45
116	EQ	Q HI-MID	INPUT46
117	EQ	Q HI-MID	INPUT47
118	EQ	Q HI-MID	INPUT48
119	NO ASSIGN		



## CHANNEL9

#	High	Mid	Low
0	NO ASSIGN		
1	EQ	G HIGH H	INPUT1
2	EQ	G HIGH H	INPUT2
3	EQ	G HIGH H	INPUT3
4	EQ	G HIGH H	INPUT4
5	EQ	G HIGH H	INPUT5
6	EQ	G HIGH H	INPUT6
7	EQ	G HIGH H	INPUT7
8	EQ	G HIGH H	INPUT8
9	EQ	G HIGH H	INPUT9
10	EQ	G HIGH H	INPUT10
11	EQ	G HIGH H	INPUT11
12	EQ	G HIGH H	INPUT12
13	EQ	G HIGH H	INPUT13
14	EQ	G HIGH H	INPUT14
15	EQ	G HIGH H	INPUT15
16	EQ	G HIGH H	INPUT16
17	EQ	G HIGH H	INPUT17
18	EQ	G HIGH H	INPUT18
19	EQ	G HIGH H	INPUT19
20	EQ	G HIGH H	INPUT20
21	EQ	G HIGH H	INPUT21
22	EQ	G HIGH H	INPUT22
23	EQ	G HIGH H	INPUT23
24	EQ	G HIGH H	INPUT24
25	NO ASSIGN		
26	NO ASSIGN		
27	NO ASSIGN		
28	NO ASSIGN		
29	NO ASSIGN		
30	NO ASSIGN		
31	NO ASSIGN		
32	NO ASSIGN		
33	EQ	G HIGH L	INPUT1
34	EQ	G HIGH L	INPUT2
35	EQ	G HIGH L	INPUT3
36	EQ	G HIGH L	INPUT4
37	EQ	G HIGH L	INPUT5
38	EQ	G HIGH L	INPUT6
39	EQ	G HIGH L	INPUT7
40	EQ	G HIGH L	INPUT8
41	EQ	G HIGH L	INPUT9
42	EQ	G HIGH L	INPUT10
43	EQ	G HIGH L	INPUT11
44	EQ	G HIGH L	INPUT12
45	EQ	G HIGH L	INPUT13
46	EQ	G HIGH L	INPUT14
47	EQ	G HIGH L	INPUT15
48	EQ	G HIGH L	INPUT16
49	EQ	G HIGH L	INPUT17
50	EQ	G HIGH L	INPUT18
51	EQ	G HIGH L	INPUT19
52	EQ	G HIGH L	INPUT20
53	EQ	G HIGH L	INPUT21
54	EQ	G HIGH L	INPUT22
55	EQ	G HIGH L	INPUT23
56	EQ	G HIGH L	INPUT24
57	NO ASSIGN		
58	NO ASSIGN		

#	High	Mid	Low
59	NO ASSIGN		
60	NO ASSIGN		
61	NO ASSIGN		
62	NO ASSIGN		
63	NO ASSIGN		
64	EQ	F HIGH	INPUT1
65	EQ	F HIGH	INPUT2
66	EQ	F HIGH	INPUT3
67	EQ	F HIGH	INPUT4
68	EQ	F HIGH	INPUT5
69	EQ	F HIGH	INPUT6
70	EQ	F HIGH	INPUT7
71	EQ	F HIGH	INPUT8
72	EQ	F HIGH	INPUT9
73	EQ	F HIGH	INPUT10
74	EQ	F HIGH	INPUT11
75	EQ	F HIGH	INPUT12
76	EQ	F HIGH	INPUT13
77	EQ	F HIGH	INPUT14
78	EQ	F HIGH	INPUT15
79	EQ	F HIGH	INPUT16
80	EQ	F HIGH	INPUT17
81	EQ	F HIGH	INPUT18
82	EQ	F HIGH	INPUT19
83	EQ	F HIGH	INPUT20
84	EQ	F HIGH	INPUT21
85	EQ	F HIGH	INPUT22
86	EQ	F HIGH	INPUT23
87	EQ	F HIGH	INPUT24
88	NO ASSIGN		
89	EQ	Q HIGH	INPUT1
90	EQ	Q HIGH	INPUT2
91	EQ	Q HIGH	INPUT3
92	EQ	Q HIGH	INPUT4
93	EQ	Q HIGH	INPUT5
94	EQ	Q HIGH	INPUT6
95	EQ	Q HIGH	INPUT7
102	EQ	Q HIGH	INPUT8
103	EQ	Q HIGH	INPUT9
104	EQ	Q HIGH	INPUT10
105	EQ	Q HIGH	INPUT11
106	EQ	Q HIGH	INPUT12
107	EQ	Q HIGH	INPUT13
108	EQ	Q HIGH	INPUT14
109	EQ	Q HIGH	INPUT15
110	EQ	Q HIGH	INPUT16
111	EQ	Q HIGH	INPUT17
112	EQ	Q HIGH	INPUT18
113	EQ	Q HIGH	INPUT19
114	EQ	Q HIGH	INPUT20
115	EQ	Q HIGH	INPUT21
116	EQ	Q HIGH	INPUT22
117	EQ	Q HIGH	INPUT23
118	EQ	Q HIGH	INPUT24
119	NO ASSIGN		

## CHANNEL10

#	High	Mid	Low
0	NO ASSIGN		
1	EQ	G HIGH H	INPUT25
2	EQ	G HIGH H	INPUT26
3	EQ	G HIGH H	INPUT27
4	EQ	G HIGH H	INPUT28
5	EQ	G HIGH H	INPUT29
6	EQ	G HIGH H	INPUT30
7	EQ	G HIGH H	INPUT31
8	EQ	G HIGH H	INPUT32
9	EQ	G HIGH H	INPUT33
10	EQ	G HIGH H	INPUT34
11	EQ	G HIGH H	INPUT35
12	EQ	G HIGH H	INPUT36
13	EQ	G HIGH H	INPUT37
14	EQ	G HIGH H	INPUT38
15	EQ	G HIGH H	INPUT39
16	EQ	G HIGH H	INPUT40
17	EQ	G HIGH H	INPUT41
18	EQ	G HIGH H	INPUT42
19	EQ	G HIGH H	INPUT43
20	EQ	G HIGH H	INPUT44
21	EQ	G HIGH H	INPUT45
22	EQ	G HIGH H	INPUT46
23	EQ	G HIGH H	INPUT47
24	EQ	G HIGH H	INPUT48
25	NO ASSIGN		
26	NO ASSIGN		
27	NO ASSIGN		
28	NO ASSIGN		
29	NO ASSIGN		
30	NO ASSIGN		
31	NO ASSIGN		
32	NO ASSIGN		
33	EQ	G HIGH L	INPUT25
34	EQ	G HIGH L	INPUT26
35	EQ	G HIGH L	INPUT27
36	EQ	G HIGH L	INPUT28
37	EQ	G HIGH L	INPUT29
38	EQ	G HIGH L	INPUT30
39	EQ	G HIGH L	INPUT31
40	EQ	G HIGH L	INPUT32
41	EQ	G HIGH L	INPUT33
42	EQ	G HIGH L	INPUT34
43	EQ	G HIGH L	INPUT35
44	EQ	G HIGH L	INPUT36
45	EQ	G HIGH L	INPUT37
46	EQ	G HIGH L	INPUT38
47	EQ	G HIGH L	INPUT39
48	EQ	G HIGH L	INPUT40
49	EQ	G HIGH L	INPUT41
50	EQ	G HIGH L	INPUT42
51	EQ	G HIGH L	INPUT43
52	EQ	G HIGH L	INPUT44
53	EQ	G HIGH L	INPUT45
54	EQ	G HIGH L	INPUT46
55	EQ	G HIGH L	INPUT47
56	EQ	G HIGH L	INPUT48
57	NO ASSIGN		
58	NO ASSIGN		

#	High	Mid	Low
59	NO ASSIGN		
60	NO ASSIGN		
61	NO ASSIGN		
62	NO ASSIGN		
63	NO ASSIGN		
64	EQ	F HIGH	INPUT25
65	EQ	F HIGH	INPUT26
66	EQ	F HIGH	INPUT27
67	EQ	F HIGH	INPUT28
68	EQ	F HIGH	INPUT29
69	EQ	F HIGH	INPUT30
70	EQ	F HIGH	INPUT31
71	EQ	F HIGH	INPUT32
72	EQ	F HIGH	INPUT33
73	EQ	F HIGH	INPUT34
74	EQ	F HIGH	INPUT35
75	EQ	F HIGH	INPUT36
76	EQ	F HIGH	INPUT37
77	EQ	F HIGH	INPUT38
78	EQ	F HIGH	INPUT39
79	EQ	F HIGH	INPUT40
80	EQ	F HIGH	INPUT41
81	EQ	F HIGH	INPUT42
82	EQ	F HIGH	INPUT43
83	EQ	F HIGH	INPUT44
84	EQ	F HIGH	INPUT45
85	EQ	F HIGH	INPUT46
86	EQ	F HIGH	INPUT47
87	EQ	F HIGH	INPUT48
88	NO ASSIGN		
89	EQ	Q HIGH	INPUT25
90	EQ	Q HIGH	INPUT26
91	EQ	Q HIGH	INPUT27
92	EQ	Q HIGH	INPUT28
93	EQ	Q HIGH	INPUT29
94	EQ	Q HIGH	INPUT30
95	EQ	Q HIGH	INPUT31
102	EQ	Q HIGH	INPUT32
103	EQ	Q HIGH	INPUT33
104	EQ	Q HIGH	INPUT34
105	EQ	Q HIGH	INPUT35
106	EQ	Q HIGH	INPUT36
107	EQ	Q HIGH	INPUT37
108	EQ	Q HIGH	INPUT38
109	EQ	Q HIGH	INPUT39
110	EQ	Q HIGH	INPUT40
111	EQ	Q HIGH	INPUT41
112	EQ	Q HIGH	INPUT42
113	EQ	Q HIGH	INPUT43
114	EQ	Q HIGH	INPUT44
115	EQ	Q HIGH	INPUT45
116	EQ	Q HIGH	INPUT46
117	EQ	Q HIGH	INPUT47
118	EQ	Q HIGH	INPUT48
119	NO ASSIGN		

## CHANNEL11

#	High	Mid	Low
0	NO ASSIGN		
1	EQ	ATT H	INPUT1
2	EQ	ATT H	INPUT2
3	EQ	ATT H	INPUT3
4	EQ	ATT H	INPUT4
5	EQ	ATT H	INPUT5
6	EQ	ATT H	INPUT6
7	EQ	ATT H	INPUT7
8	EQ	ATT H	INPUT8
9	EQ	ATT H	INPUT9
10	EQ	ATT H	INPUT10
11	EQ	ATT H	INPUT11
12	EQ	ATT H	INPUT12
13	EQ	ATT H	INPUT13
14	EQ	ATT H	INPUT14
15	EQ	ATT H	INPUT15
16	EQ	ATT H	INPUT16
17	EQ	ATT H	INPUT17
18	EQ	ATT H	INPUT18
19	EQ	ATT H	INPUT19
20	EQ	ATT H	INPUT20
21	EQ	ATT H	INPUT21
22	EQ	ATT H	INPUT22
23	EQ	ATT H	INPUT23
24	EQ	ATT H	INPUT24
25	NO ASSIGN		
26	NO ASSIGN		
27	NO ASSIGN		
28	NO ASSIGN		
29	NO ASSIGN		
30	NO ASSIGN		
31	NO ASSIGN		
32	NO ASSIGN		
33	EQ	ATT L	INPUT1
34	EQ	ATT L	INPUT2
35	EQ	ATT L	INPUT3
36	EQ	ATT L	INPUT4
37	EQ	ATT L	INPUT5
38	EQ	ATT L	INPUT6
39	EQ	ATT L	INPUT7
40	EQ	ATT L	INPUT8
41	EQ	ATT L	INPUT9
42	EQ	ATT L	INPUT10
43	EQ	ATT L	INPUT11
44	EQ	ATT L	INPUT12
45	EQ	ATT L	INPUT13
46	EQ	ATT L	INPUT14
47	EQ	ATT L	INPUT15
48	EQ	ATT L	INPUT16
49	EQ	ATT L	INPUT17
50	EQ	ATT L	INPUT18
51	EQ	ATT L	INPUT19
52	EQ	ATT L	INPUT20
53	EQ	ATT L	INPUT21
54	EQ	ATT L	INPUT22
55	EQ	ATT L	INPUT23
56	EQ	ATT L	INPUT24
57	NO ASSIGN		
58	NO ASSIGN		

#	High	Mid	Low
59	NO ASSIGN		
60	NO ASSIGN		
61	NO ASSIGN		
62	NO ASSIGN		
63	NO ASSIGN		
64	EQ	HPF ON	INPUT1
65	EQ	HPF ON	INPUT2
66	EQ	HPF ON	INPUT3
67	EQ	HPF ON	INPUT4
68	EQ	HPF ON	INPUT5
69	EQ	HPF ON	INPUT6
70	EQ	HPF ON	INPUT7
71	EQ	HPF ON	INPUT8
72	EQ	HPF ON	INPUT9
73	EQ	HPF ON	INPUT10
74	EQ	HPF ON	INPUT11
75	EQ	HPF ON	INPUT12
76	EQ	HPF ON	INPUT13
77	EQ	HPF ON	INPUT14
78	EQ	HPF ON	INPUT15
79	EQ	HPF ON	INPUT16
80	EQ	HPF ON	INPUT17
81	EQ	HPF ON	INPUT18
82	EQ	HPF ON	INPUT19
83	EQ	HPF ON	INPUT20
84	EQ	HPF ON	INPUT21
85	EQ	HPF ON	INPUT22
86	EQ	HPF ON	INPUT23
87	EQ	HPF ON	INPUT24
88	NO ASSIGN		
89	EQ	LPF ON	INPUT1
90	EQ	LPF ON	INPUT2
91	EQ	LPF ON	INPUT3
92	EQ	LPF ON	INPUT4
93	EQ	LPF ON	INPUT5
94	EQ	LPF ON	INPUT6
95	EQ	LPF ON	INPUT7
102	EQ	LPF ON	INPUT8
103	EQ	LPF ON	INPUT9
104	EQ	LPF ON	INPUT10
105	EQ	LPF ON	INPUT11
106	EQ	LPF ON	INPUT12
107	EQ	LPF ON	INPUT13
108	EQ	LPF ON	INPUT14
109	EQ	LPF ON	INPUT15
110	EQ	LPF ON	INPUT16
111	EQ	LPF ON	INPUT17
112	EQ	LPF ON	INPUT18
113	EQ	LPF ON	INPUT19
114	EQ	LPF ON	INPUT20
115	EQ	LPF ON	INPUT21
116	EQ	LPF ON	INPUT22
117	EQ	LPF ON	INPUT23
118	EQ	LPF ON	INPUT24
119	NO ASSIGN		

**CHANNEL12**

#	High	Mid	Low
0	NO ASSIGN		
1	EQ	ATT H	INPUT25
2	EQ	ATT H	INPUT26
3	EQ	ATT H	INPUT27
4	EQ	ATT H	INPUT28
5	EQ	ATT H	INPUT29
6	EQ	ATT H	INPUT30
7	EQ	ATT H	INPUT31
8	EQ	ATT H	INPUT32
9	EQ	ATT H	INPUT33
10	EQ	ATT H	INPUT34
11	EQ	ATT H	INPUT35
12	EQ	ATT H	INPUT36
13	EQ	ATT H	INPUT37
14	EQ	ATT H	INPUT38
15	EQ	ATT H	INPUT39
16	EQ	ATT H	INPUT40
17	EQ	ATT H	INPUT41
18	EQ	ATT H	INPUT42
19	EQ	ATT H	INPUT43
20	EQ	ATT H	INPUT44
21	EQ	ATT H	INPUT45
22	EQ	ATT H	INPUT46
23	EQ	ATT H	INPUT47
24	EQ	ATT H	INPUT48
25	NO ASSIGN		
26	NO ASSIGN		
27	NO ASSIGN		
28	NO ASSIGN		
29	NO ASSIGN		
30	NO ASSIGN		
31	NO ASSIGN		
32	NO ASSIGN		
33	EQ	ATT L	INPUT25
34	EQ	ATT L	INPUT26
35	EQ	ATT L	INPUT27
36	EQ	ATT L	INPUT28
37	EQ	ATT L	INPUT29
38	EQ	ATT L	INPUT30
39	EQ	ATT L	INPUT31
40	EQ	ATT L	INPUT32
41	EQ	ATT L	INPUT33
42	EQ	ATT L	INPUT34
43	EQ	ATT L	INPUT35
44	EQ	ATT L	INPUT36
45	EQ	ATT L	INPUT37
46	EQ	ATT L	INPUT38
47	EQ	ATT L	INPUT39
48	EQ	ATT L	INPUT40
49	EQ	ATT L	INPUT41
50	EQ	ATT L	INPUT42
51	EQ	ATT L	INPUT43
52	EQ	ATT L	INPUT44
53	EQ	ATT L	INPUT45
54	EQ	ATT L	INPUT46
55	EQ	ATT L	INPUT47
56	EQ	ATT L	INPUT48
57	NO ASSIGN		
58	NO ASSIGN		

#	High	Mid	Low
59	NO ASSIGN		
60	NO ASSIGN		
61	NO ASSIGN		
62	NO ASSIGN		
63	NO ASSIGN		
64	EQ	HPF ON	INPUT25
65	EQ	HPF ON	INPUT26
66	EQ	HPF ON	INPUT27
67	EQ	HPF ON	INPUT28
68	EQ	HPF ON	INPUT29
69	EQ	HPF ON	INPUT30
70	EQ	HPF ON	INPUT31
71	EQ	HPF ON	INPUT32
72	EQ	HPF ON	INPUT33
73	EQ	HPF ON	INPUT34
74	EQ	HPF ON	INPUT35
75	EQ	HPF ON	INPUT36
76	EQ	HPF ON	INPUT37
77	EQ	HPF ON	INPUT38
78	EQ	HPF ON	INPUT39
79	EQ	HPF ON	INPUT40
80	EQ	HPF ON	INPUT41
81	EQ	HPF ON	INPUT42
82	EQ	HPF ON	INPUT43
83	EQ	HPF ON	INPUT44
84	EQ	HPF ON	INPUT45
85	EQ	HPF ON	INPUT46
86	EQ	HPF ON	INPUT47
87	EQ	HPF ON	INPUT48
88	NO ASSIGN		
89	EQ	LPF ON	INPUT25
90	EQ	LPF ON	INPUT26
91	EQ	LPF ON	INPUT27
92	EQ	LPF ON	INPUT28
93	EQ	LPF ON	INPUT29
94	EQ	LPF ON	INPUT30
95	EQ	LPF ON	INPUT31
102	EQ	LPF ON	INPUT32
103	EQ	LPF ON	INPUT33
104	EQ	LPF ON	INPUT34
105	EQ	LPF ON	INPUT35
106	EQ	LPF ON	INPUT36
107	EQ	LPF ON	INPUT37
108	EQ	LPF ON	INPUT38
109	EQ	LPF ON	INPUT39
110	EQ	LPF ON	INPUT40
111	EQ	LPF ON	INPUT41
112	EQ	LPF ON	INPUT42
113	EQ	LPF ON	INPUT43
114	EQ	LPF ON	INPUT44
115	EQ	LPF ON	INPUT45
116	EQ	LPF ON	INPUT46
117	EQ	LPF ON	INPUT47
118	EQ	LPF ON	INPUT48
119	NO ASSIGN		

## CHANNEL13

#	High	Mid	Low
0	NO ASSIGN		
1	SURROUND	LFE H	INPUT1
2	SURROUND	LFE H	INPUT2
3	SURROUND	LFE H	INPUT3
4	SURROUND	LFE H	INPUT4
5	SURROUND	LFE H	INPUT5
6	SURROUND	LFE H	INPUT6
7	SURROUND	LFE H	INPUT7
8	SURROUND	LFE H	INPUT8
9	SURROUND	LFE H	INPUT9
10	SURROUND	LFE H	INPUT10
11	SURROUND	LFE H	INPUT11
12	SURROUND	LFE H	INPUT12
13	SURROUND	LFE H	INPUT13
14	SURROUND	LFE H	INPUT14
15	SURROUND	LFE H	INPUT15
16	SURROUND	LFE H	INPUT16
17	SURROUND	LFE H	INPUT17
18	SURROUND	LFE H	INPUT18
19	SURROUND	LFE H	INPUT19
20	SURROUND	LFE H	INPUT20
21	SURROUND	LFE H	INPUT21
22	SURROUND	LFE H	INPUT22
23	SURROUND	LFE H	INPUT23
24	SURROUND	LFE H	INPUT24
25	NO ASSIGN		
26	NO ASSIGN		
27	NO ASSIGN		
28	NO ASSIGN		
29	NO ASSIGN		
30	NO ASSIGN		
31	NO ASSIGN		
32	NO ASSIGN		
33	SURROUND	LFE L	INPUT1
34	SURROUND	LFE L	INPUT2
35	SURROUND	LFE L	INPUT3
36	SURROUND	LFE L	INPUT4
37	SURROUND	LFE L	INPUT5
38	SURROUND	LFE L	INPUT6
39	SURROUND	LFE L	INPUT7
40	SURROUND	LFE L	INPUT8
41	SURROUND	LFE L	INPUT9
42	SURROUND	LFE L	INPUT10
43	SURROUND	LFE L	INPUT11
44	SURROUND	LFE L	INPUT12
45	SURROUND	LFE L	INPUT13
46	SURROUND	LFE L	INPUT14
47	SURROUND	LFE L	INPUT15
48	SURROUND	LFE L	INPUT16
49	SURROUND	LFE L	INPUT17
50	SURROUND	LFE L	INPUT18
51	SURROUND	LFE L	INPUT19
52	SURROUND	LFE L	INPUT20
53	SURROUND	LFE L	INPUT21
54	SURROUND	LFE L	INPUT22
55	SURROUND	LFE L	INPUT23
56	SURROUND	LFE L	INPUT24
57	NO ASSIGN		
58	NO ASSIGN		

#	High	Mid	Low
59	NO ASSIGN		
60	NO ASSIGN		
61	NO ASSIGN		
62	NO ASSIGN		
63	NO ASSIGN		
64	SURROUND	DIV F	INPUT1
65	SURROUND	DIV F	INPUT2
66	SURROUND	DIV F	INPUT3
67	SURROUND	DIV F	INPUT4
68	SURROUND	DIV F	INPUT5
69	SURROUND	DIV F	INPUT6
70	SURROUND	DIV F	INPUT7
71	SURROUND	DIV F	INPUT8
72	SURROUND	DIV F	INPUT9
73	SURROUND	DIV F	INPUT10
74	SURROUND	DIV F	INPUT11
75	SURROUND	DIV F	INPUT12
76	SURROUND	DIV F	INPUT13
77	SURROUND	DIV F	INPUT14
78	SURROUND	DIV F	INPUT15
79	SURROUND	DIV F	INPUT16
80	SURROUND	DIV F	INPUT17
81	SURROUND	DIV F	INPUT18
82	SURROUND	DIV F	INPUT19
83	SURROUND	DIV F	INPUT20
84	SURROUND	DIV F	INPUT21
85	SURROUND	DIV F	INPUT22
86	SURROUND	DIV F	INPUT23
87	SURROUND	DIV F	INPUT24
88	NO ASSIGN		
89	EQ	ON	INPUT1
90	EQ	ON	INPUT2
91	EQ	ON	INPUT3
92	EQ	ON	INPUT4
93	EQ	ON	INPUT5
94	EQ	ON	INPUT6
95	EQ	ON	INPUT7
102	EQ	ON	INPUT8
103	EQ	ON	INPUT9
104	EQ	ON	INPUT10
105	EQ	ON	INPUT11
106	EQ	ON	INPUT12
107	EQ	ON	INPUT13
108	EQ	ON	INPUT14
109	EQ	ON	INPUT15
110	EQ	ON	INPUT16
111	EQ	ON	INPUT17
112	EQ	ON	INPUT18
113	EQ	ON	INPUT19
114	EQ	ON	INPUT20
115	EQ	ON	INPUT21
116	EQ	ON	INPUT22
117	EQ	ON	INPUT23
118	EQ	ON	INPUT24
119	NO ASSIGN		

**CHANNEL14**

#	High	Mid	Low
0	NO ASSIGN		
1	SURROUND	LFE H	INPUT25
2	SURROUND	LFE H	INPUT26
3	SURROUND	LFE H	INPUT27
4	SURROUND	LFE H	INPUT28
5	SURROUND	LFE H	INPUT29
6	SURROUND	LFE H	INPUT30
7	SURROUND	LFE H	INPUT31
8	SURROUND	LFE H	INPUT32
9	SURROUND	LFE H	INPUT33
10	SURROUND	LFE H	INPUT34
11	SURROUND	LFE H	INPUT35
12	SURROUND	LFE H	INPUT36
13	SURROUND	LFE H	INPUT37
14	SURROUND	LFE H	INPUT38
15	SURROUND	LFE H	INPUT39
16	SURROUND	LFE H	INPUT40
17	SURROUND	LFE H	INPUT41
18	SURROUND	LFE H	INPUT42
19	SURROUND	LFE H	INPUT43
20	SURROUND	LFE H	INPUT44
21	SURROUND	LFE H	INPUT45
22	SURROUND	LFE H	INPUT46
23	SURROUND	LFE H	INPUT47
24	SURROUND	LFE H	INPUT48
25	NO ASSIGN		
26	NO ASSIGN		
27	NO ASSIGN		
28	NO ASSIGN		
29	NO ASSIGN		
30	NO ASSIGN		
31	NO ASSIGN		
32	NO ASSIGN		
33	SURROUND	LFE L	INPUT25
34	SURROUND	LFE L	INPUT26
35	SURROUND	LFE L	INPUT27
36	SURROUND	LFE L	INPUT28
37	SURROUND	LFE L	INPUT29
38	SURROUND	LFE L	INPUT30
39	SURROUND	LFE L	INPUT31
40	SURROUND	LFE L	INPUT32
41	SURROUND	LFE L	INPUT33
42	SURROUND	LFE L	INPUT34
43	SURROUND	LFE L	INPUT35
44	SURROUND	LFE L	INPUT36
45	SURROUND	LFE L	INPUT37
46	SURROUND	LFE L	INPUT38
47	SURROUND	LFE L	INPUT39
48	SURROUND	LFE L	INPUT40
49	SURROUND	LFE L	INPUT41
50	SURROUND	LFE L	INPUT42
51	SURROUND	LFE L	INPUT43
52	SURROUND	LFE L	INPUT44
53	SURROUND	LFE L	INPUT45
54	SURROUND	LFE L	INPUT46
55	SURROUND	LFE L	INPUT47
56	SURROUND	LFE L	INPUT48
57	NO ASSIGN		
58	NO ASSIGN		

#	High	Mid	Low
59	NO ASSIGN		
60	NO ASSIGN		
61	NO ASSIGN		
62	NO ASSIGN		
63	NO ASSIGN		
64	SURROUND	DIV F	INPUT25
65	SURROUND	DIV F	INPUT26
66	SURROUND	DIV F	INPUT27
67	SURROUND	DIV F	INPUT28
68	SURROUND	DIV F	INPUT29
69	SURROUND	DIV F	INPUT30
70	SURROUND	DIV F	INPUT31
71	SURROUND	DIV F	INPUT32
72	SURROUND	DIV F	INPUT33
73	SURROUND	DIV F	INPUT34
74	SURROUND	DIV F	INPUT35
75	SURROUND	DIV F	INPUT36
76	SURROUND	DIV F	INPUT37
77	SURROUND	DIV F	INPUT38
78	SURROUND	DIV F	INPUT39
79	SURROUND	DIV F	INPUT40
80	SURROUND	DIV F	INPUT41
81	SURROUND	DIV F	INPUT42
82	SURROUND	DIV F	INPUT43
83	SURROUND	DIV F	INPUT44
84	SURROUND	DIV F	INPUT45
85	SURROUND	DIV F	INPUT46
86	SURROUND	DIV F	INPUT47
87	SURROUND	DIV F	INPUT48
88	NO ASSIGN		
89	EQ	ON	INPUT25
90	EQ	ON	INPUT26
91	EQ	ON	INPUT27
92	EQ	ON	INPUT28
93	EQ	ON	INPUT29
94	EQ	ON	INPUT30
95	EQ	ON	INPUT31
102	EQ	ON	INPUT32
103	EQ	ON	INPUT33
104	EQ	ON	INPUT34
105	EQ	ON	INPUT35
106	EQ	ON	INPUT36
107	EQ	ON	INPUT37
108	EQ	ON	INPUT38
109	EQ	ON	INPUT39
110	EQ	ON	INPUT40
111	EQ	ON	INPUT41
112	EQ	ON	INPUT42
113	EQ	ON	INPUT43
114	EQ	ON	INPUT44
115	EQ	ON	INPUT45
116	EQ	ON	INPUT46
117	EQ	ON	INPUT47
118	EQ	ON	INPUT48
119	NO ASSIGN		

## CHANNEL15

#	High	Mid	Low
0	NO ASSIGN		
1	SURROUND	LR	INPUT1
2	SURROUND	LR	INPUT2
3	SURROUND	LR	INPUT3
4	SURROUND	LR	INPUT4
5	SURROUND	LR	INPUT5
6	SURROUND	LR	INPUT6
7	SURROUND	LR	INPUT7
8	SURROUND	LR	INPUT8
9	SURROUND	LR	INPUT9
10	SURROUND	LR	INPUT10
11	SURROUND	LR	INPUT11
12	SURROUND	LR	INPUT12
13	SURROUND	LR	INPUT13
14	SURROUND	LR	INPUT14
15	SURROUND	LR	INPUT15
16	SURROUND	LR	INPUT16
17	SURROUND	LR	INPUT17
18	SURROUND	LR	INPUT18
19	SURROUND	LR	INPUT19
20	SURROUND	LR	INPUT20
21	SURROUND	LR	INPUT21
22	SURROUND	LR	INPUT22
23	SURROUND	LR	INPUT23
24	SURROUND	LR	INPUT24
25	NO ASSIGN		
26	NO ASSIGN		
27	NO ASSIGN		
28	NO ASSIGN		
29	NO ASSIGN		
30	NO ASSIGN		
31	NO ASSIGN		
32	NO ASSIGN		
33	SURROUND	FR	INPUT1
34	SURROUND	FR	INPUT2
35	SURROUND	FR	INPUT3
36	SURROUND	FR	INPUT4
37	SURROUND	FR	INPUT5
38	SURROUND	FR	INPUT6
39	SURROUND	FR	INPUT7
40	SURROUND	FR	INPUT8
41	SURROUND	FR	INPUT9
42	SURROUND	FR	INPUT10
43	SURROUND	FR	INPUT11
44	SURROUND	FR	INPUT12
45	SURROUND	FR	INPUT13
46	SURROUND	FR	INPUT14
47	SURROUND	FR	INPUT15
48	SURROUND	FR	INPUT16
49	SURROUND	FR	INPUT17
50	SURROUND	FR	INPUT18
51	SURROUND	FR	INPUT19
52	SURROUND	FR	INPUT20
53	SURROUND	FR	INPUT21
54	SURROUND	FR	INPUT22
55	SURROUND	FR	INPUT23
56	SURROUND	FR	INPUT24
57	NO ASSIGN		
58	NO ASSIGN		

#	High	Mid	Low
59	NO ASSIGN		
60	NO ASSIGN		
61	NO ASSIGN		
62	NO ASSIGN		
63	NO ASSIGN		
64	SURROUND	WIDTH	INPUT1
65	SURROUND	WIDTH	INPUT2
66	SURROUND	WIDTH	INPUT3
67	SURROUND	WIDTH	INPUT4
68	SURROUND	WIDTH	INPUT5
69	SURROUND	WIDTH	INPUT6
70	SURROUND	WIDTH	INPUT7
71	SURROUND	WIDTH	INPUT8
72	SURROUND	WIDTH	INPUT9
73	SURROUND	WIDTH	INPUT10
74	SURROUND	WIDTH	INPUT11
75	SURROUND	WIDTH	INPUT12
76	SURROUND	WIDTH	INPUT13
77	SURROUND	WIDTH	INPUT14
78	SURROUND	WIDTH	INPUT15
79	SURROUND	WIDTH	INPUT16
80	SURROUND	WIDTH	INPUT17
81	SURROUND	WIDTH	INPUT18
82	SURROUND	WIDTH	INPUT19
83	SURROUND	WIDTH	INPUT20
84	SURROUND	WIDTH	INPUT21
85	SURROUND	WIDTH	INPUT22
86	SURROUND	WIDTH	INPUT23
87	SURROUND	WIDTH	INPUT24
88	NO ASSIGN		
89	SURROUND	DEPTH	INPUT1
90	SURROUND	DEPTH	INPUT2
91	SURROUND	DEPTH	INPUT3
92	SURROUND	DEPTH	INPUT4
93	SURROUND	DEPTH	INPUT5
94	SURROUND	DEPTH	INPUT6
95	SURROUND	DEPTH	INPUT7
102	SURROUND	DEPTH	INPUT8
103	SURROUND	DEPTH	INPUT9
104	SURROUND	DEPTH	INPUT10
105	SURROUND	DEPTH	INPUT11
106	SURROUND	DEPTH	INPUT12
107	SURROUND	DEPTH	INPUT13
108	SURROUND	DEPTH	INPUT14
109	SURROUND	DEPTH	INPUT15
110	SURROUND	DEPTH	INPUT16
111	SURROUND	DEPTH	INPUT17
112	SURROUND	DEPTH	INPUT18
113	SURROUND	DEPTH	INPUT19
114	SURROUND	DEPTH	INPUT20
115	SURROUND	DEPTH	INPUT21
116	SURROUND	DEPTH	INPUT22
117	SURROUND	DEPTH	INPUT23
118	SURROUND	DEPTH	INPUT24
119	NO ASSIGN		

## CHANNEL16

#	High	Mid	Low
0	NO ASSIGN		
1	SURROUND	LR	INPUT25
2	SURROUND	LR	INPUT26
3	SURROUND	LR	INPUT27
4	SURROUND	LR	INPUT28
5	SURROUND	LR	INPUT29
6	SURROUND	LR	INPUT30
7	SURROUND	LR	INPUT31
8	SURROUND	LR	INPUT32
9	SURROUND	LR	INPUT33
10	SURROUND	LR	INPUT34
11	SURROUND	LR	INPUT35
12	SURROUND	LR	INPUT36
13	SURROUND	LR	INPUT37
14	SURROUND	LR	INPUT38
15	SURROUND	LR	INPUT39
16	SURROUND	LR	INPUT40
17	SURROUND	LR	INPUT41
18	SURROUND	LR	INPUT42
19	SURROUND	LR	INPUT43
20	SURROUND	LR	INPUT44
21	SURROUND	LR	INPUT45
22	SURROUND	LR	INPUT46
23	SURROUND	LR	INPUT47
24	SURROUND	LR	INPUT48
25	NO ASSIGN		
26	NO ASSIGN		
27	NO ASSIGN		
28	NO ASSIGN		
29	NO ASSIGN		
30	NO ASSIGN		
31	NO ASSIGN		
32	NO ASSIGN		
33	SURROUND	FR	INPUT25
34	SURROUND	FR	INPUT26
35	SURROUND	FR	INPUT27
36	SURROUND	FR	INPUT28
37	SURROUND	FR	INPUT29
38	SURROUND	FR	INPUT30
39	SURROUND	FR	INPUT31
40	SURROUND	FR	INPUT32
41	SURROUND	FR	INPUT33
42	SURROUND	FR	INPUT34
43	SURROUND	FR	INPUT35
44	SURROUND	FR	INPUT36
45	SURROUND	FR	INPUT37
46	SURROUND	FR	INPUT38
47	SURROUND	FR	INPUT39
48	SURROUND	FR	INPUT40
49	SURROUND	FR	INPUT41
50	SURROUND	FR	INPUT42
51	SURROUND	FR	INPUT43
52	SURROUND	FR	INPUT44
53	SURROUND	FR	INPUT45
54	SURROUND	FR	INPUT46
55	SURROUND	FR	INPUT47
56	SURROUND	FR	INPUT48
57	NO ASSIGN		
58	NO ASSIGN		

#	High	Mid	Low
59	NO ASSIGN		
60	NO ASSIGN		
61	NO ASSIGN		
62	NO ASSIGN		
63	NO ASSIGN		
64	SURROUND	WIDTH	INPUT25
65	SURROUND	WIDTH	INPUT26
66	SURROUND	WIDTH	INPUT27
67	SURROUND	WIDTH	INPUT28
68	SURROUND	WIDTH	INPUT29
69	SURROUND	WIDTH	INPUT30
70	SURROUND	WIDTH	INPUT31
71	SURROUND	WIDTH	INPUT32
72	SURROUND	WIDTH	INPUT33
73	SURROUND	WIDTH	INPUT34
74	SURROUND	WIDTH	INPUT35
75	SURROUND	WIDTH	INPUT36
76	SURROUND	WIDTH	INPUT37
77	SURROUND	WIDTH	INPUT38
78	SURROUND	WIDTH	INPUT39
79	SURROUND	WIDTH	INPUT40
80	SURROUND	WIDTH	INPUT41
81	SURROUND	WIDTH	INPUT42
82	SURROUND	WIDTH	INPUT43
83	SURROUND	WIDTH	INPUT44
84	SURROUND	WIDTH	INPUT45
85	SURROUND	WIDTH	INPUT46
86	SURROUND	WIDTH	INPUT47
87	SURROUND	WIDTH	INPUT48
88	NO ASSIGN		
89	SURROUND	DEPTH	INPUT25
90	SURROUND	DEPTH	INPUT26
91	SURROUND	DEPTH	INPUT27
92	SURROUND	DEPTH	INPUT28
93	SURROUND	DEPTH	INPUT29
94	SURROUND	DEPTH	INPUT30
95	SURROUND	DEPTH	INPUT31
102	SURROUND	DEPTH	INPUT32
103	SURROUND	DEPTH	INPUT33
104	SURROUND	DEPTH	INPUT34
105	SURROUND	DEPTH	INPUT35
106	SURROUND	DEPTH	INPUT36
107	SURROUND	DEPTH	INPUT37
108	SURROUND	DEPTH	INPUT38
109	SURROUND	DEPTH	INPUT39
110	SURROUND	DEPTH	INPUT40
111	SURROUND	DEPTH	INPUT41
112	SURROUND	DEPTH	INPUT42
113	SURROUND	DEPTH	INPUT43
114	SURROUND	DEPTH	INPUT44
115	SURROUND	DEPTH	INPUT45
116	SURROUND	DEPTH	INPUT46
117	SURROUND	DEPTH	INPUT47
118	SURROUND	DEPTH	INPUT48
119	NO ASSIGN		



# MIDI Data Format

## 1. DATA FORMAT

### 1.1 CHANNEL MESSAGE

Command	rx/tx	function
8n NOTE OFF	rx	Control the internal effects
9n NOTE ON	rx	Control the internal effects
Bn CONTROL CHANGE	rx/tx	Control parameters
Cn PROGRAM CHANGE	rx/tx	Switch scene memories

### 1.2 SYSTEM COMMON MESSAGE

Command	rx/tx	function
F1 MIDI TIME CODE QUARTER FRAME	rx	MTC
F2 SONG POSITION POINTER	rx	Used when TIME REFERENCE is MIDI CLOCK.

### 1.3 SYSTEM REALTIME MESSAGE

Command	rx/tx	function
F8 TIMING CLOCK	rx	MIDI clock
FA START	rx	Start automix (from the beginning)
FB CONTINUE	rx	Start automix (from the middle)
FC STOP	rx	Stop automix
FE ACTIVE SENSING	rx	Check MIDI cable connections
FF RESET	rx	Clear running status

### 1.4 EXCLUSIVE MESSAGE

#### 1.4.1 Real Time System Exclusive

Command	rx/tx	function
F0 7F dd 06 ... F7 MMC COMMAND	tx	MMC command
F0 7F dd 07 ... F7 MMC RESPONSE	rx	MMC response
F0 7F dd 01 ... F7 MIDI TIME CODE	rx	MTC full message

#### 1.4.2 System Exclusive Message

##### 1.4.2.1 Bulk Dump

Command	rx/tx	function
F0 43 0n 7E ... F7 BULK DUMP DATA	rx/tx	BULK DUMP DATA
F0 43 2n 7E ... F7 BULK DUMP REQUEST	rx/tx	BULK DUMP REQUEST

The following data types of bulk dump are used on the DM1000.

Data name	tx/rx	function
'm'	tx/rx	Scene Memory & Request (compressed data)
'S'	tx/rx	Setup Memory & Request
'a'	tx/rx	Automix data & Request (compressed data)
'R'	tx/rx	Input patch library & Request
'O'	tx/rx	Output patch library & Request
'H'	tx/rx	Channel library & Request
'G'	tx/rx	Gate library & Request
'Y'	tx/rx	Compressor library & Request
'Q'	tx/rx	Equalizer library & Request
'E'	tx/rx	Effect library & Request
'J'	tx/rx	Bus to Stereo library & Request
'K'	tx/rx	Surround Monitor library & Request
'P'	tx/rx	Program change table & Request
'C'	tx/rx	Control change table & Request
'L'	tx/rx	User define layer & Request
'V'	tx/rx	User define key & Request
'U'	tx/rx	User assignable layer & Request
'N'	tx/rx	Plug-in Effect Card Data & Request

#### 1.4.2.2 PARAMETER CHANGE

Command	rx/tx	function
F0 43 1n 3E 0C ... F7 PARAMETER CHANGE	rx/tx	DM1000-specific parameter change
F0 43 3n 3E 0C ... F7 PARAMETER REQUEST	rx/tx	DM1000-specific parameter change
F0 43 1n 3E 7F ... F7 PARAMETER CHANGE	rx/tx	General purpose digital mixer parameter change
F0 43 3n 3E 7F ... F7 PARAMETER REQUEST	rx/tx	General purpose digital mixer parameter request

The following data types of parameter change are used by the DM1000.

Type (HEX)	tx/rx	function
1 (01)	tx/rx	Edit buffer
2 (02)	tx/rx	Patch data
3 (03)	tx/rx	Setup data
4 (04)	tx/rx	Backup data
15 (0F)	tx/rx	Cascade data
16 (10)	tx/rx	Function (recall, store, title, clear)
17 (11)	rx	Function (pair, copy)
18 (12)	rx	Function (effect)
19 (13)	tx/rx	Sort table
20 (14)	tx/rx	Function (attribute, link)
32 (20)	rx	Key remote
33 (21)	tx/rx	Remote meter
34 (22)	tx/rx	Remote time counter
35 (23)	tx/rx	Automix status
80 (50)	tx/rx	Function response (recall, store, title, clear)
84 (54)	tx/rx	Function response (attribute, link)
126 (7E)	tx/rx	System Attribute
127 (7F)	tx	Active sense

\* 'tx' indicates that the data can be transmitted from the DM1000, and 'rx' indicates that the data can be received by the DM1000.

## 2. Format Details

### 2.1 NOTE OFF (8n)

#### Reception

If [OTHER ECHO] is ON, these message are echoed from MIDI OUT. If the [Rx CH] matches, these messages are received and used to control effects.

STATUS	1000nnnn	8n	Note off message
DATA	0nnnnnnn	nn	Note number
	0vvvvvvv	vv	Velocity(ignored)

### 2.2 NOTE ON (9n)

#### Reception

If [OTHER ECHO] is ON, these messages are echoed from MIDI OUT. If the [Rx CH] matches, these messages are received and used to control effects.

STATUS	1001nnnn	9n	Note on message
DATA	0nnnnnnn	nn	Note number
	0vvvvvvv	vv	Velocity(1-127:on, 0:off)

### 2.3 CONTROL CHANGE (Bn)

#### Reception

If [Control Change ECHO] is ON, these messages are echoed from MIDI OUT. If [TABLE] is selected, these message are received if [Control Change Rx] is ON, and will control parameters according to the [Control assign table] settings. The parameters that can be set are defined in the Control Change Assign Parameter List.

If [NRPN] is selected, these messages are received if [Control Change Rx] is ON and the [Rx CH] matches, and will control the parameter that is specified by the four messages NRPN control number (62h, 63h) and Data Entry control number (06h, 26h). Parameter settings are defined in the Control Change Assign Parameter List.

**Transmission**

If [TABLE] is selected, operating a parameter specified in the [Control assign table] will cause these messages to be transmitted if [Control Change Tx] is ON. The parameters that can be specified are defined in the Control Change Assign Parameter List.

If [NRPN] is selected, operating a specified parameter will cause data to be transmitted on the [Tx CH] if [Control Change Tx] is ON, using the four messages NRPN control number (62h, 63h) and Data Entry control number (06h, 26h). Parameter settings are defined in the Control Change Assign Parameter List.

This data cannot be transmitted via control change to Studio Manager since there is no guarantee that the contents of the tables will match. (Parameter Change messages will always be used.)

**If [TABLE] is selected**

```
STATUS 1011nnnn Bn Control change
DATA 0nnnnnnn nn Control number (0-95, 102-119)
0vvvvvvv vv Control Value (0-127)
```

**If [NRPN] is selected**

```
STATUS 1011nnnn Bn Control change
DATA 01100010 62 NRPN LSB
0vvvvvvv vv LSB of parameter number

STATUS 1011nnnn Bn Control change *1
DATA 01100011 63 NRPN MSB
0vvvvvvv vv MSB of parameter number

STATUS 1011nnnn Bn Control change *1
DATA 00000110 06 MSB of data entry
0vvvvvvv vv MSB of parameter data

STATUS 1011nnnn Bn Control change *1
DATA 00100110 26 LSB of data entry
0vvvvvvv vv LSB of parameter data
```

\*1) The second and subsequent STATUS need not be added during transmission. Reception must be implemented so that reception occurs whether or not STATUS is present.

**2.4 PROGRAM CHANGE (Cn)****Reception**

If [Program Change ECHO] is ON, these messages are echoed from MIDI OUT.

If [Program Change RX] is ON and the [Rx CH] matches, these messages will be received. However if [OMNI] is ON, they will be received regardless of the channel. When a message is received, a Scene Memory will be recalled according to the settings of the [Program Change Table].

**Transmission**

If [Program Change TX] is ON, this message is transmitted according to the settings of the [Program Change Table] on the [Tx CH] channel when a scene memory is recalled.

If the recalled scene has been assigned to more than one program number, the lowest-numbered program number will be transmitted. Transmission to Studio Manager using Program Change messages will not be performed since there is no guarantee that the contents of the tables will match. (Parameter Changes will always be used.)

```
STATUS 1100nnnn Cn Program change
DATA 0nnnnnnn nn Program number (0-127)
```

**2.5 SONG POSITION POINTER (F2)****Reception**

If this is received when the automix TIME REFERENCE setting is MIDI CLOCK, the automix will move to the song position that was received.

```
STATUS 11110010 F2 Song position pointer
DATA 0vvvvvvv vv Song position LSB
0vvvvvvv vv Song position MSB
```

**2.6 TIMING CLOCK (F8)****Reception**

If the automix TIME REFERENCE setting is MIDI CLOCK, this message is used to synchronize automix. It is also used to control effects. This message is transmitted 24 times per quarter note.

```
STATUS 11111000 F8 Timing clock
```

**2.7 START (FA)****Reception**

This message is received if the automix TIME REFERENCE setting is MIDI CLOCK, and will start the automix. In actuality, automix will start when the next TIMING CLOCK is received after receiving the START message.

```
STATUS 11111010 FA Start
```

**2.8 CONTINUE (FB)****Reception**

This message is received if the automix TIME REFERENCE setting is MIDI CLOCK, and will cause automix to start from the current song position. In actuality, automix will start when the next TIMING CLOCK is received after receiving the CONTINUE message.

```
STATUS 11111011 FB Continue
```

**2.9 STOP (FC)****Reception**

This message is received if the automix TIME REFERENCE setting is MIDI CLOCK, and will cause automix to stop.

```
STATUS 11111100 FC Stop
```

**2.10 ACTIVE SENSING (FE)****Reception**

Once this message has been received, the failure to receive any message for an interval of 400 ms or longer will cause MIDI transmission to be initialized, such as by clearing the Running Status.

```
STATUS 11111110 FE Active sensing
```

**2.11 SYSTEM RESET (FF)****Reception**

When this message is received, MIDI communications will be cleared, e.g., by clearing the Running Status.

```
STATUS 11111111 FF System reset
```

**2.12 SYSTEM EXCLUSIVE MESSAGE (F0)****2.12.1 MIDI MACHINE CONTROL (MMC)**

These messages are transmitted when the Machine Control section of the DM1000 is operated.

**2.12.2 BULK DUMP**

This message sends or receives the contents of various memories stored within the DM1000.

The basic format is as follows.

**For DUMP DATA**

```
F0 43 0n 7E cc cc <Model ID> tt mm mm [Data ...] cs F7
```

**For DUMP REQUEST**

```
F0 43 2n 7E <Model ID> tt mm mm F7
```

```
n Device Number
cc cc DATA COUNT (the number of bytes that follow this, ending before the checksum)
4C 4D 20 20 38 43 39 31 Model ID
tt DATA TYPE
mm mm DATA NUMBER
cs CHECK SUM
```

A unique header (Model ID) is used to determine whether the device is a DM1000.

CHECK SUM is obtained by adding the bytes that follow BYTE COUNT (LOW) and end before CHECK SUM, taking the binary compliment of this sum, and then setting bit 7 to 0.

```
CHECK SUM = (~sum) & 0x7F
```

**Reception**

This message is received if [Bulk RX] is ON and the [Rx CH] matches the device number included in the SUB STATUS.

When a bulk dump is received, it is immediately written into the specified memory.

When a bulk dump request is received, a bulk dump is immediately transmitted.

**Transmission**

This message is transmitted on the [Tx CH] by key operations in the [MIDI]-[BULK DUMP] screen.

A bulk dump is transmitted on the [Rx CH] in response to a bulk dump request. The data area is handled by converting seven words of 8-bit data into eight words of 7-bit data.

**Conversion from actual data into bulk data**

```
d[0~6]: actual data
b[0~7]: bulk data
b[0] = 0;
for( I=0; I<7; I++){
    if( d[I]&0x80){
        b[0] |= 1<<(6-I);
    }
    b[I+1] = d[I]&0x7F;
}
}
```

**Restoration from bulk data into actual data**

```
d[0~6]: actual data
b[0~7]: bulk data
for( I=0; I<7; I++){
    b[0] <<= 1;
    d[I] = b[I+1]+(0x80&b[0]);
}
}
```

**2.12.2.1 Scene memory bulk dump format (compress)**

The DM1000 can transmit and receive scene memories in compressed form.

STATUS	11110000	F0	System exclusive message
ID No.	01000011	43	Manufacture's ID number (YAMAHA)
SUB STATUS	0000nnnn	0n	n=0-15 (Device number=MIDI Channel)
FORMAT No.	01111110	7E	Universal bulk dump
COUNT HIGH	0ccccccc	ch	data count = ch * 128 + cl
COUNT LOW	0ccccccc	cl	
	01001100	4C	'L'
	01001101	4D	'M'
	00100000	20	''
	00100000	20	''
	00111000	38	'8'
	01000011	43	'C'
	00111001	39	'9'
	00110001	31	'1'
DATA NAME	01101101	6D	'm'
	0mmmmmm	mh	m=0-99, 256, 8192(Scene0-99, EDIT BUFFER, UNDO)
	0mmmmmm	m1	Receive is effective 1-99, 256, 8192
BLOCK INFO.	0ttttttt	tt	total block number(minimum number is 0)
	0bbbbbbb	bb	current block number(0-total block number)
DATA	0ddddd	ds	Scene data of block[bb]
	:	:	
	0ddddd	de	
CHECK SUM	0eeeeeee	ee	ee=(Invert('L'+...+de)+1)&0x7F
EOX	11110111	F7	End of exclusive

**2.12.2.2 Scene memory bulk dump request format (compress)**

The second and third bytes of the DATA NAME indicate the scene number that is being requested. If this is 256, the data of the Edit Buffer will be bulk-dumped. If this is 8192, the data of the Undo Buffer will be bulk-dumped.

STATUS	11110000	F0	System exclusive message
ID No.	01000011	43	Manufacture's ID number (YAMAHA)
SUB STATUS	0010nnnn	2n	n=0-15 (Device number=MIDI Channel)
FORMAT No.	01111110	7E	Universal bulk dump
	01001100	4C	'L'
	01001101	4D	'M'
	00100000	20	''
	00100000	20	''
	00111000	38	'8'
	01000011	43	'C'
	00111001	39	'9'
	00110001	31	'1'
DATA NAME	01101101	6D	'm'

	0mmmmmm	mh	m=0-99, 256, 8192(Scene0-99, EDIT BUFFER, UNDO)
	0mmmmmm	m1	Receive is effective 1-99, 256, 8192
EOX	11110111	F7	End of exclusive

**2.12.2.3 Setup memory bulk dump format**

Of the setup memory of the DM1000, this bulk-dumps data other than the User define layer, User define plug-in, User define keys, Control change table, and Program change table.

STATUS	11110000	F0	System exclusive message
ID No.	01000011	43	Manufacture's ID number (YAMAHA)
SUB STATUS	0000nnnn	0n	n=0-15 (Device number=MIDI Channel)
FORMAT No.	01111110	7E	Universal bulk dump
COUNT HIGH	0ccccccc	ch	data count = ch * 128 + cl
COUNT LOW	0ccccccc	cl	
	01001100	4C	'L'
	01001101	4D	'M'
	00100000	20	''
	00100000	20	''
	00111000	38	'8'
	01000011	43	'C'
	00111001	39	'9'
	00110001	31	'1'
DATA NAME	01010011	53	'S'
	00000010	02	
	00000000	00	No.256 = Current
BLOCK INFO.	0ttttttt	tt	total block number(minimum number is 0)
	0bbbbbbb	bb	current block number(0-total block number)
DATA	0ddddd	ds	Setup data of block[bb]
	:	:	
	0ddddd	de	
CHECK SUM	0eeeeeee	ee	ee=(Invert('L'+...+de)+1)&0x7F
EOX	11110111	F7	End of exclusive

**2.12.2.4 Setup memory bulk dump request format**

STATUS	11110000	F0	System exclusive message
ID No.	01000011	43	Manufacture's ID number (YAMAHA)
SUB STATUS	0010nnnn	2n	n=0-15 (Device number=MIDI Channel)
FORMAT No.	01111110	7E	Universal bulk dump
	01001100	4C	'L'
	01001101	4D	'M'
	00100000	20	''
	00100000	20	''
	00111000	38	'8'
	01000011	43	'C'
	00111001	39	'9'
	00110001	31	'1'
DATA NAME	01010011	53	'S'
	00000010	02	
	00000000	00	No.256 = Current
EOX	11110111	F7	End of exclusive

**2.12.2.5 User Defined MIDI Remote bulk dump format**

The second and third bytes of the DATA NAME indicate the bank number. Be aware that the state of the transmission destination will (in some cases) change if the same bank is being used.

STATUS	11110000	F0	System exclusive message
ID No.	01000011	43	Manufacture's ID number (YAMAHA)
SUB STATUS	0000nnnn	0n	n=0-15 (Device number=MIDI Channel)
FORMAT No.	01111110	7E	Universal bulk dump
COUNT HIGH	0ccccccc	ch	data count = ch * 128 + cl
COUNT LOW	0ccccccc	cl	
	01001100	4C	'L'
	01001101	4D	'M'
	00100000	20	''
	00100000	20	''
	00111000	38	'8'
	01000011	43	'C'
	00111001	39	'9'
	00110001	31	'1'

```

DATA NAME 01001100 4C 'L'
           00000000 00
           0bbbbbbb bb b=0-3(bank no.1-4)
BLOCK INFO. 0ttttttt tt total block number(minimum number is 0)
           0bbbbbbb bb current block number(0-total block number)
DATA       0ddddddd ds User define layer data of block[bb]
           :
           :
           0ddddddd de
CHECK SUM 0eeeeeee ee ee=(Invert('L'+...+de)+1)&0x7F
EOX       11110111 F7 End of exclusive
    
```

**2.12.2.6 User Defined MIDI Remote bulk dump request format**

The second and third bytes of the DATA NAME indicate the bank number.

```

STATUS     11110000 F0 System exclusive message
ID No.     01000011 43 Manufacture's ID number (YAMAHA)
SUB STATUS 0010nnnn 2n n=0-15 (Device number=MIDI Channel)
FORMAT No. 01111110 7E Universal bulk dump
           01001100 4C 'L'
           01001101 4D 'M'
           00100000 20 ''
           00100000 20 ''
           00111000 38 '8'
           01000011 43 'C'
           00111001 39 '9'
           00110001 31 '1'
DATA NAME  01001100 4C 'L'
           00000000 00
           0bbbbbbb bb b=0-3(bank no.1-4)
EOX       11110111 F7 End of exclusive
    
```

**2.12.2.7 User Defined Keys bulk dump format**

The second and third bytes of the DATA NAME indicate the bank number. Be aware that the state of the transmission destination will (in some cases) change if the same bank is being used.

```

STATUS     11110000 F0 System exclusive message
ID No.     01000011 43 Manufacture's ID number (YAMAHA)
SUB STATUS 0000nnnn 0n n=0-15 (Device number=MIDI Channel)
FORMAT No. 01111110 7E Universal bulk dump
COUNT HIGH 0ccccccc ch data count = ch * 128 + cl
COUNT LOW  0ccccccc cl
           01001100 4C 'L'
           01001101 4D 'M'
           00100000 20 ''
           00100000 20 ''
           00111000 38 '8'
           01000011 43 'C'
           00111001 39 '9'
           00110001 31 '1'
DATA NAME  01010110 56 'V'
           00000000 00
           0bbbbbbb bb b=0-7(bank no.A-H)
BLOCK INFO. 0ttttttt tt total block number(minimum number is 0)
           0bbbbbbb bb current block number(0-total block number)
DATA       0ddddddd ds User define key data of block[bb]
           :
           :
           0ddddddd de
CHECK SUM  0eeeeeee ee ee=(Invert('L'+...+de)+1)&0x7F
EOX       11110111 F7 End of exclusive
    
```

**2.12.2.8 User Defined Keys bulk dump request format**

The second and third bytes of the DATA NAME indicate the bank number.

```

STATUS     11110000 F0 System exclusive message
ID No.     01000011 43 Manufacture's ID number (YAMAHA)
SUB STATUS 0010nnnn 2n n=0-15 (Device number=MIDI Channel)
FORMAT No. 01111110 7E Universal bulk dump
           01001100 4C 'L'
           01001101 4D 'M'
           00100000 20 ''
           00100000 20 ''
           00111000 38 '8'
           01000011 43 'C'
           00111001 39 '9'
           00110001 31 '1'
DATA NAME  01010110 56 'V'
           00000000 00
           0bbbbbbb bb b=0-7(bank no.A-H)
EOX       11110111 F7 End of exclusive
    
```

**2.12.2.9 User Assignable Layer bulk dump format**

The second and third bytes of the DATA NAME indicate the bank number. Be aware that the state of the transmission destination will (in some cases) change if the same bank is being used.

```

STATUS     11110000 F0 System exclusive message
ID No.     01000011 43 Manufacture's ID number (YAMAHA)
SUB STATUS 0000nnnn 0n n=0-15 (Device number=MIDI Channel)
FORMAT No. 01111110 7E Universal bulk dump
COUNT HIGH 0ccccccc ch data count = ch * 128 + cl
COUNT LOW  0ccccccc cl
           01001100 4C 'L'
           01001101 4D 'M'
           00100000 20 ''
           00100000 20 ''
           00111000 38 '8'
           01000011 43 'C'
           00111001 39 '9'
           00110001 31 '1'
DATA NAME  01010101 55 'U'
           00000000 00
           0bbbbbbb bb b=0-3(bank no.1-4)
BLOCK INFO. 0ttttttt tt total block number(minimum number is 0)
           0bbbbbbb bb current block number(0-total block number)
DATA       0ddddddd ds User assignable layer data of block[bb]
           :
           :
           0ddddddd de
CHECK SUM  0eeeeeee ee ee=(Invert('L'+...+de)+1)&0x7F
EOX       11110111 F7 End of exclusive
    
```

**2.12.2.10 User Assignable Layer bulk dump request format**

The second and third bytes of the DATA NAME indicate the bank number.

```

STATUS     11110000 F0 System exclusive message
ID No.     01000011 43 Manufacture's ID number (YAMAHA)
SUB STATUS 0010nnnn 2n n=0-15 (Device number=MIDI Channel)
FORMAT No. 01111110 7E Universal bulk dump
           01001100 4C 'L'
           01001101 4D 'M'
           00100000 20 ''
           00100000 20 ''
           00111000 38 '8'
           01000011 43 'C'
           00111001 39 '9'
           00110001 31 '1'
DATA NAME  01010101 55 'U'
           00000000 00
           0bbbbbbb bb b=0-3(bank no.1-4)
EOX       11110111 F7 End of exclusive
    
```

**2.12.2.11 Control change table bulk dump format**

```

STATUS      11110000 F0 System exclusive message
ID No.      01000011 43 Manufacture's ID number (YAMAHA)
SUB STATUS  0000nnnn 0n n=0-15 (Device number=MIDI Channel)
FORMAT No.  01111110 7E Universal bulk dump
COUNT HIGH 0ccccccc ch data count = ch * 128 + cl
COUNT LOW  0ccccccc cl
              01001100 4C 'L'
              01001101 4D 'M'
              00100000 20 ''
              00100000 20 ''
              00111000 38 '8'
              01000011 43 'C'
              00111001 39 '9'
              00110001 31 '1'
DATA NAME   01000011 43 'C'
              00000010 02
              00000000 00 No.256 = Current
BLOCK INFO. 0ttttttt tt total block number(minimum number is 0)
              0bbbbbbb bb current block number(0-total block number)
DATA        0ddddddd ds Control change table data of block[bb]
              :
              :
              0ddddddd de
CHECK SUM   0eeeeeee ee ee=(Invert('L'+...+de)+1)&0x7F
EOX        11110111 F7 End of exclusive

```

**2.12.2.12 Control change table bulk dump request format**

```

STATUS      11110000 F0 System exclusive message
ID No.      01000011 43 Manufacture's ID number (YAMAHA)
SUB STATUS  0010nnnn 2n n=0-15 (Device number=MIDI Channel)
FORMAT No.  01111110 7E Universal bulk dump
COUNT HIGH 0ccccccc ch data count = ch * 128 + cl
COUNT LOW  0ccccccc cl
              01001100 4C 'L'
              01001101 4D 'M'
              00100000 20 ''
              00100000 20 ''
              00111000 38 '8'
              01000011 43 'C'
              00111001 39 '9'
              00110001 31 '1'
DATA NAME   01000011 43 'C'
              00000010 02
              00000000 00 No.256 = Current
EOX        11110111 F7 End of exclusive

```

**2.12.2.13 Program change table bulk dump format**

```

STATUS      11110000 F0 System exclusive message
ID No.      01000011 43 Manufacture's ID number (YAMAHA)
SUB STATUS  0000nnnn 0n n=0-15 (Device number=MIDI Channel)
FORMAT No.  01111110 7E Universal bulk dump
COUNT HIGH 0ccccccc ch data count = ch * 128 + cl
COUNT LOW  0ccccccc cl
              01001100 4C 'L'
              01001101 4D 'M'
              00100000 20 ''
              00100000 20 ''
              00111000 38 '8'
              01000011 43 'C'
              00111001 39 '9'
              00110001 31 '1'
DATA NAME   01010000 50 'P'
              00000010 02
              00000000 00 No.256 = Current
BLOCK INFO. 0ttttttt tt total block number(minimum number is 0)
              0bbbbbbb bb current block number(0-total block number)
DATA        0ddddddd ds Program change table data of block[bb]
              :
              :
              0ddddddd de
CHECK SUM   0eeeeeee ee ee=(Invert('L'+...+de)+1)&0x7F
EOX        11110111 F7 End of exclusive

```

**2.12.2.14 Program change table bulk dump request format**

```

STATUS      11110000 F0 System exclusive message
ID No.      01000011 43 Manufacture's ID number (YAMAHA)
SUB STATUS  0010nnnn 2n n=0-15 (Device number=MIDI Channel)
FORMAT No.  01111110 7E Universal bulk dump
COUNT HIGH 01001100 4C 'L'
              01001101 4D 'M'
              00100000 20 ''
              00100000 20 ''
              00111000 38 '8'
              01000011 43 'C'
              00111001 39 '9'
              00110001 31 '1'
DATA NAME   01010000 50 'P'
              00000010 02
              00000000 00 No.256 = Current
EOX        11110111 F7 End of exclusive

```

**2.12.2.15 Equalizer library bulk dump format**

The second and third bytes of the DATA NAME indicate the bank number.  
 0:Library no.1 – 199:Library no.200,  
 256:CH1 – 303:CH48, 384:BUS1 – 391:BUS8, 512:AUX1 – 519:AUX8, 768:STE-  
 REO, 8192:UNDO

256 and following are data for the corresponding channel of the edit buffer.  
 For reception by the DM1000, only the user area is valid. (40-199, 256-)

```

STATUS      11110000 F0 System exclusive message
ID No.      01000011 43 Manufacture's ID number (YAMAHA)
SUB STATUS  0000nnnn 0n n=0-15 (Device number=MIDI Channel)
FORMAT No.  01111110 7E Universal bulk dump
COUNT HIGH 0ccccccc ch data count = ch * 128 + cl
COUNT LOW  0ccccccc cl
              01001100 4C 'L'
              01001101 4D 'M'
              00100000 20 ''
              00100000 20 ''
              00111000 38 '8'
              01000011 43 'C'
              00111001 39 '9'
              00110001 31 '1'
DATA NAME   01010001 51 'Q'
              0mmmmmmm mh 0-127(EQ Library no.1-128),
              0mmmmmmm ml 256-(Channel current data)
BLOCK INFO. 0ttttttt tt total block number(minimum number is 0)
              0bbbbbbb bb current block number(0-total block number)
DATA        0ddddddd ds EQ Library data of block[bb]
              :
              :
              0ddddddd de
CHECK SUM   0eeeeeee ee ee=(Invert('L'+...+de)+1)&0x7F
EOX        11110111 F7 End of exclusive

```

**2.12.2.16 Equalizer library bulk dump request format**

The second and third bytes of the DATA NAME indicate the bank number. (See above)

```

STATUS      11110000 F0 System exclusive message
ID No.      01000011 43 Manufacture's ID number (YAMAHA)
SUB STATUS  0010nnnn 2n n=0-15 (Device number=MIDI Channel)
FORMAT No.  01111110 7E Universal bulk dump
COUNT HIGH 01001100 4C 'L'
              01001101 4D 'M'
              00100000 20 ''
              00100000 20 ''
              00111000 38 '8'
              01000011 43 'C'
              00111001 39 '9'
              00110001 31 '1'
DATA NAME   01010001 51 'Q'
              0mmmmmmm mh 0-127(EQ Library no.1-128),
              0mmmmmmm ml 256-(Channel current data)
EOX        11110111 F7 End of exclusive

```

### 2.12.2.17 Compressor library bulk dump format

The second and third bytes of the DATA NAME indicate the library number.  
0:Library no.1 – 127:Library no.128,  
256:CH1 – 303:CH48, 384:BUS1 – 391:BUS8, 512:AUX1 – 519:AUX8, 768:STE-  
REO, 8192:UNDO

256 and following are data for the corresponding channel of the edit buffer.  
For reception by the DM1000, only the user area is valid. (36-127, 256-)

```

STATUS      11110000 F0 System exclusive message
ID No.     01000011 43 Manufacture's ID number (YAMAHA)
SUB STATUS 0000nnnn 0n n=0-15 (Device number=MIDI Channel)
FORMAT No. 01111110 7E Universal bulk dump
COUNT HIGH 0ccccccc ch data count = ch * 128 + cl
COUNT LOW 0ccccccc cl
            01001100 4C 'L'
            01001101 4D 'M'
            00100000 20 ''
            00100000 20 ''
            00111000 38 '8'
            01000011 43 'C'
            00111001 39 '9'
            00110001 31 '1'
DATA NAME  01011001 59 'Y'
            0mmmmmmm mh 0-127(COMP Library no.1-128),
            0mmmmmmm ml 256-(Channel current data)
BLOCK INFO. 0ttttttt tt total block number(minimum number is 0)
            0bbbbbbb bb current block number(0-total block number)
DATA       0ddddddd ds COMP Library data of block[bb]
            :
            0ddddddd de
CHECK SUM  0eeeeeee ee ee=(Invert('L'+...+de)+1)&0x7F
EOX       11110111 F7 End of exclusive

```

### 2.12.2.18 Compressor library bulk dump request format

The second and third bytes of the DATA NAME indicate the library number.  
(See above)

```

STATUS      11110000 F0 System exclusive message
ID No.     01000011 43 Manufacture's ID number (YAMAHA)
SUB STATUS 0010nnnn 2n n=0-15 (Device number=MIDI Channel)
FORMAT No. 01111110 7E Universal bulk dump
            01001100 4C 'L'
            01001101 4D 'M'
            00100000 20 ''
            00100000 20 ''
            00111000 38 '8'
            01000011 43 'C'
            00111001 39 '9'
            00110001 31 '1'
DATA NAME  01011001 59 'Y'
            0mmmmmmm mh 0-127(COMP Library no.1-128),
            0mmmmmmm ml 256-(Channel current data)
EOX       11110111 F7 End of exclusive

```

### 2.12.2.19 Gate library bulk dump format

The second and third bytes of the DATA NAME indicate the library number.  
0:Library no.1 – 127:Library no.128, 256:CH1 – 303:CH48, 8192:UNDO  
256 and following are data for the corresponding channel of the edit buffer.  
For reception by the DM1000, only the user area is valid. (4-127, 256-)

```

STATUS      11110000 F0 System exclusive message
ID No.     01000011 43 Manufacture's ID number (YAMAHA)
SUB STATUS 0000nnnn 0n n=0-15 (Device number=MIDI Channel)
FORMAT No. 01111110 7E Universal bulk dump
COUNT HIGH 0ccccccc ch data count = ch * 128 + cl
COUNT LOW 0ccccccc cl
            01001100 4C 'L'
            01001101 4D 'M'
            00100000 20 ''
            00100000 20 ''
            00111000 38 '8'
            01000011 43 'C'
            00111001 39 '9'

```

```

            00110001 31 '1'
DATA NAME  01000111 47 'G'
            0mmmmmmm mh 0-127(GATE Library no.1-128),
            0mmmmmmm ml 256-351(Channel current data)
BLOCK INFO. 0ttttttt tt total block number(minimum number is 0)
            0bbbbbbb bb current block number(0-total block number)
DATA       0ddddddd ds GATE Library data of block[bb]
            :
            0ddddddd de
CHECK SUM  0eeeeeee ee ee=(Invert('L'+...+de)+1)&0x7F
EOX       11110111 F7 End of exclusive

```

### 2.12.2.20 Gate library bulk dump request format

The second and third bytes of the DATA NAME indicate the library number.  
(See above)

```

STATUS      11110000 F0 System exclusive message
ID No.     01000011 43 Manufacture's ID number (YAMAHA)
SUB STATUS 0010nnnn 2n n=0-15 (Device number=MIDI Channel)
FORMAT No. 01111110 7E Universal bulk dump
            01001100 4C 'L'
            01001101 4D 'M'
            00100000 20 ''
            00100000 20 ''
            00111000 38 '8'
            01000011 43 'C'
            00111001 39 '9'
            00110001 31 '1'
DATA NAME  01000111 47 'G'
            0mmmmmmm mh 0-127(GATE Library no.1-128),
            0mmmmmmm ml 256-351(Channel current data)
EOX       11110111 F7 End of exclusive

```

### 2.12.2.21 Effect library bulk dump format

The second and third bytes of the DATA NAME indicate the library number.  
0:Library no.1 – 127:Library no.128, 256:EFFECT1 – 259:EFFECT4, 8192:UN-  
DO  
256-263 are the data for the corresponding area of the edit buffer.  
For reception by the DM1000, only the user area is valid. (52-127, 256-259,  
8192)

```

STATUS      11110000 F0 System exclusive message
ID No.     01000011 43 Manufacture's ID number (YAMAHA)
SUB STATUS 0000nnnn 0n n=0-15 (Device number=MIDI Channel)
FORMAT No. 01111110 7E Universal bulk dump
COUNT HIGH 0ccccccc ch data count = ch * 128 + cl
COUNT LOW 0ccccccc cl
            01001100 4C 'L'
            01001101 4D 'M'
            00100000 20 ''
            00100000 20 ''
            00111000 38 '8'
            01000011 43 'C'
            00111001 39 '9'
            00110001 31 '1'
DATA NAME  01000101 45 'E'
            0mmmmmmm mh 0-127(Effect Library no.1-128),
            0mmmmmmm ml 256-259(Effect1-4 current)
BLOCK INFO. 0ttttttt tt total block number(minimum number is 0)
            0bbbbbbb bb current block number(0-total block number)
DATA       0ddddddd ds Effect Library data of block[bb]
            :
            0ddddddd de
CHECK SUM  0eeeeeee ee ee=(Invert('L'+...+de)+1)&0x7F
EOX       11110111 F7 End of exclusive

```

**2.12.2.22 Effect library bulk dump request format**

The second and third bytes of the DATA NAME indicate the library number.  
(See above)

```

STATUS      11110000 F0 System exclusive message
ID No.      01000011 43 Manufacture's ID number (YAMAHA)
SUB STATUS  0010nnnn 2n n=0-15 (Device number=MIDI Channel)
FORMAT No.  01111110 7E Universal bulk dump
             01001100 4C 'L'
             01001101 4D 'M'
             00100000 20 ''
             00100000 20 ''
             00111000 38 '8'
             01000011 43 'C'
             00111001 39 '9'
             00110001 31 '1'
DATA NAME   01000101 45 'E'
             0mmmmmmmm mh 0-127(Effect Library no.1-128),
             0mmmmmmmm ml 256-259(Effect1-4 current)
EOX         11110111 F7 End of exclusive

```

**2.12.2.23 Channel library bulk dump format**

The second and third bytes of the DATA NAME indicate the library number.  
0:Library no.0 – 128:Library no.128,  
256:CH1 – 303:CH48, 384:BUS1 – 391:BUS8, 512:AUX1 – 519:AUX8, 768:STE-  
REO, 8192:UNDO  
256 and following are the data for the corresponding channel of the edit buffer.  
For reception by the DM1000, only the user area is valid. (2-128, 256-)

```

STATUS      11110000 F0 System exclusive message
ID No.      01000011 43 Manufacture's ID number (YAMAHA)
SUB STATUS  0000nnnn 0n n=0-15 (Device number=MIDI Channel)
FORMAT No.  01111110 7E Universal bulk dump
COUNT HIGH 0ccccccc ch data count = ch * 128 + cl
COUNT LOW  0ccccccc cl
             01001100 4C 'L'
             01001101 4D 'M'
             00100000 20 ''
             00100000 20 ''
             00111000 38 '8'
             01000011 43 'C'
             00111001 39 '9'
             00110001 31 '1'
DATA NAME   01001000 48 'H'
             0mmmmmmmm mh 0-128(Channel Library no.0-128),
             0mmmmmmmm ml 256-(Current data)
BLOCK INFO. 0ttttttt tt total block number(minimum number is 0)
             0bbbbbbb bb current block number(0-total block number)
DATA        0ddddd ds Channel Library data of block[bb]
             :
             :
             0ddddd de
CHECK SUM   0eeeeeee ee ee=(Invert('L'+...+de)+1)&0x7F
EOX         11110111 F7 End of exclusive

```

**2.12.2.24 Channel library bulk dump request format**

The second and third bytes of the DATA NAME indicate the library number.  
(See above)

```

STATUS      11110000 F0 System exclusive message
ID No.      01000011 43 Manufacture's ID number (YAMAHA)
SUB STATUS  0010nnnn 2n n=0-15 (Device number=MIDI Channel)
FORMAT No.  01111110 7E Universal bulk dump
             01001100 4C 'L'
             01001101 4D 'M'
             00100000 20 ''
             00100000 20 ''
             00111000 38 '8'
             01000011 43 'C'
             00111001 39 '9'
             00110001 31 '1'
DATA NAME   01001000 48 'H'
             0mmmmmmmm mh 0-128(Channel Library no.0-128),
             0mmmmmmmm ml 256-(Current data)

```

```
EOX         11110111 F7 End of exclusive
```

**2.12.2.25 Input patch library bulk dump format**

The second and third bytes of the DATA NAME indicate the library number.  
0:Library no.0 – 32:Library no.32, 256:current input patch data, 8192:UNDO  
For reception by the DM1000, only the user area is valid. (1-32, 256, 8192)

```

STATUS      11110000 F0 System exclusive message
ID No.      01000011 43 Manufacture's ID number (YAMAHA)
SUB STATUS  0000nnnn 0n n=0-15 (Device number=MIDI Channel)
FORMAT No.  01111110 7E Universal bulk dump
COUNT HIGH 0ccccccc ch data count = ch * 128 + cl
COUNT LOW  0ccccccc cl
             01001100 4C 'L'
             01001101 4D 'M'
             00100000 20 ''
             00100000 20 ''
             00111000 38 '8'
             01000011 43 'C'
             00111001 39 '9'
             00110001 31 '1'
DATA NAME   01010010 52 'R'
             0mmmmmmmm mh 0-32(Input patch Library no.0-32),
             0mmmmmmmm ml 256(Current data)
BLOCK INFO. 0ttttttt tt total block number(minimum number is 0)
             0bbbbbbb bb current block number(0-total block number)
DATA        0ddddd ds Input patch Library data of block[bb]
             :
             :
             0ddddd de
CHECK SUM   0eeeeeee ee ee=(Invert('L'+...+de)+1)&0x7F
EOX         11110111 F7 End of exclusive

```

**2.12.2.26 Input patch library bulk dump request format**

The second and third bytes of the DATA NAME indicate the library number.  
(See above)

```

STATUS      11110000 F0 System exclusive message
ID No.      01000011 43 Manufacture's ID number (YAMAHA)
SUB STATUS  0010nnnn 2n n=0-15 (Device number=MIDI Channel)
FORMAT No.  01111110 7E Universal bulk dump
             01001100 4C 'L'
             01001101 4D 'M'
             00100000 20 ''
             00100000 20 ''
             00111000 38 '8'
             01000011 43 'C'
             00111001 39 '9'
             00110001 31 '1'
DATA NAME   01010010 52 'R'
             0mmmmmmmm mh 0-32(Input patch Library no.0-32),
             0mmmmmmmm ml 256(Current data)
EOX         11110111 F7 End of exclusive

```

**2.12.2.27 Output patch library bulk dump format**

The second and third bytes of the DATA NAME indicate the library number.  
0:Library no.0 – 32:Library no.32, 256:current output patch data, 8192:UNDO  
For reception by the DM1000, only the user area is valid. (1-32, 256)

```

STATUS      11110000 F0 System exclusive message
ID No.      01000011 43 Manufacture's ID number (YAMAHA)
SUB STATUS  0000nnnn 0n n=0-15 (Device number=MIDI Channel)
FORMAT No.  01111110 7E Universal bulk dump
COUNT HIGH 0ccccccc ch data count = ch * 128 + cl
COUNT LOW  0ccccccc cl
             01001100 4C 'L'
             01001101 4D 'M'
             00100000 20 ''
             00100000 20 ''
             00111000 38 '8'
             01000011 43 'C'
             00111001 39 '9'
             00110001 31 '1'
DATA NAME   01001111 4F 'O'

```

```

00000000 mh 0-32(Output patch Library no.0-32),
00000000 ml 256(Current data)
BLOCK INFO. 0ttttttt tt total block number(minimum number is 0)
0bbbbbbb bb current block number(0-total block number)
DATA 0ddddd ds Output patch Library data of block[bb]
: :
0ddddd de
CHECK SUM 0eeeeeee ee ee=(Invert('L'+...+de)+1)&0x7F
EOX 11110111 F7 End of exclusive

```

### 2.12.2.28 Output patch library bulk dump request format

The second and third bytes of the DATA NAME indicate the library number.  
(See above)

```

STATUS 11110000 F0 System exclusive message
ID No. 01000011 43 Manufacture's ID number (YAMAHA)
SUB STATUS 0010nnnn 2n n=0-15 (Device number=MIDI Channel)
FORMAT No. 01111110 7E Universal bulk dump
01001100 4C 'L'
01001101 4D 'M'
00100000 20 ''
00100000 20 ''
00111000 38 '8'
01000011 43 'C'
00111001 39 '9'
00110001 31 '1'
DATA NAME 01001111 4F 'O'
00000000 mh 0-32(Output patch Library no.0-32),
00000000 ml 256(Current data)
EOX 11110111 F7 End of exclusive

```

### 2.12.2.29 Bus to Stereo library bulk dump format

The second and third bytes of the DATA NAME indicate the library number.  
0:Library no.0 – 32:Library no.32, 256:current data, 8192:UNDO  
For reception by the DM1000, only the user area is valid. (1-32, 256, 8192)

```

STATUS 11110000 F0 System exclusive message
ID No. 01000011 43 Manufacture's ID number (YAMAHA)
SUB STATUS 0000nnnn 0n n=0-15 (Device number=MIDI Channel)
FORMAT No. 01111110 7E Universal bulk dump
COUNT HIGH 0ccccccc ch data count = ch * 128 + cl
COUNT LOW 0ccccccc cl
01001100 4C 'L'
01001101 4D 'M'
00100000 20 ''
00100000 20 ''
00111000 38 '8'
01000011 43 'C'
00111001 39 '9'
00110001 31 '1'
DATA NAME 01001010 4A 'J'
00000000 mh 0-32(Bus to stereo Library no.0-32),
00000000 ml 256(Current data)
BLOCK INFO. 0ttttttt tt total block number(minimum number is 0)
0bbbbbbb bb current block number(0-total block number)
DATA 0ddddd ds Bus to stereo Library data of block[bb]
: :
0ddddd de
CHECK SUM 0eeeeeee ee ee=(Invert('L'+...+de)+1)&0x7F
EOX 11110111 F7 End of exclusive

```

### 2.12.2.30 Bus to Stereo library bulk dump request format

The second and third bytes of the DATA NAME indicate the library number.  
(See above)

```

STATUS 11110000 F0 System exclusive message
ID No. 01000011 43 Manufacture's ID number (YAMAHA)
SUB STATUS 0010nnnn 2n n=0-15 (Device number=MIDI Channel)
FORMAT No. 01111110 7E Universal bulk dump
01001100 4C 'L'
01001101 4D 'M'
00100000 20 ''
00100000 20 ''
00111000 38 '8'
01000011 43 'C'
00111001 39 '9'
00110001 31 '1'
DATA NAME 01001010 4A 'J'
00000000 mh 0-32(Bus to stereo Library no.0-32),
00000000 ml 256(Current data)
EOX 11110111 F7 End of exclusive

```

### 2.12.2.31 Surround Monitor library bulk dump format

The second and third bytes of the DATA NAME indicate the library number.  
0:Library no.0 – 32:Library no.32, 256:current data, 8192:UNDO  
For reception by the DM1000, only the user area is valid. (1-32, 256, 8192)

```

STATUS 11110000 F0 System exclusive message
ID No. 01000011 43 Manufacture's ID number (YAMAHA)
SUB STATUS 0000nnnn 0n n=0-15 (Device number=MIDI Channel)
FORMAT No. 01111110 7E Universal bulk dump
COUNT HIGH 0ccccccc ch data count = ch * 128 + cl
COUNT LOW 0ccccccc cl
01001100 4C 'L'
01001101 4D 'M'
00100000 20 ''
00100000 20 ''
00111000 38 '8'
01000011 43 'C'
00111001 39 '9'
00110001 31 '1'
DATA NAME 01001011 4B 'K'
00000000 mh 0-32(Surround Monitor Library no.0-32),
00000000 ml 256(Current data)
BLOCK INFO. 0ttttttt tt total block number(minimum number is 0)
0bbbbbbb bb current block number(0-total block number)
DATA 0ddddd ds Surround Monitor Library data of block[bb]
: :
0ddddd de
CHECK SUM 0eeeeeee ee ee=(Invert('L'+...+de)+1)&0x7F
EOX 11110111 F7 End of exclusive

```

### 2.12.2.32 Surround Monitor library bulk dump request format

The second and third bytes of the DATA NAME indicate the library number.  
(See above)

```

STATUS 11110000 F0 System exclusive message
ID No. 01000011 43 Manufacture's ID number (YAMAHA)
SUB STATUS 0010nnnn 2n n=0-15 (Device number=MIDI Channel)
FORMAT No. 01111110 7E Universal bulk dump
01001100 4C 'L'
01001101 4D 'M'
00100000 20 ''
00100000 20 ''
00111000 38 '8'
01000011 43 'C'
00111001 39 '9'
00110001 31 '1'
DATA NAME 01001011 4B 'K'
00000000 mh 0-32(Surround Monitor Library no.0-32),
00000000 ml 256(Current data)
EOX 11110111 F7 End of exclusive

```



### 2.12.2.33 Automix bulk dump format

The second byte of the DATA NAME indicates the library number.  
0:Library no.1 – 15:Library no.16, 256:current automix data

```

STATUS      11110000 F0 System exclusive message
ID No.      01000011 43 Manufacture's ID number (YAMAHA)
SUB STATUS  0000nnnn 0n n=0-15 (Device number=MIDI Channel)
FORMAT No.  01111110 7E Universal bulk dump
COUNT HIGH 0ccccccc ch data count = ch * 128 + cl
COUNT LOW  0ccccccc cl
              01001100 4C 'L'
              01001101 4D 'M'
              00100000 20 ''
              00100000 20 ''
              00111000 38 '8'
              01000011 43 'C'
              00111001 39 '9'
              00110001 31 '1'
DATA NAME   01100001 61 'a'
              0mmmmmmmm mh 0-15(Automix no.1-16), 256(Current data)
              0mmmmmmmm ml
BLOCK INFO  0bbbbbbb bh current block number(0-total block number)
              0bbbbbbb bl
              0ttttttt th total block number(minimum number is 0)
              0ttttttt tl
DATA        0ddddd ds Automix memory data of block[bb]
              :
              0ddddd de
CHECK SUM   0eeeeeee ee ee=(Invert('L'+...+de)+1)&0x7F
EOX         11110111 F7 End of exclusive

```

### 2.12.2.34 Automix bulk dump request format

The second and third bytes of the DATA NAME indicate the library number.  
(See above)

```

STATUS      11110000 F0 System exclusive message
ID No.      01000011 43 Manufacture's ID number (YAMAHA)
SUB STATUS  0010nnnn 2n n=0-15 (Device number=MIDI Channel)
FORMAT No.  01111110 7E Universal bulk dump
              01001100 4C 'L'
              01001101 4D 'M'
              00100000 20 ''
              00100000 20 ''
              00111000 38 '8'
              01000011 43 'C'
              00111001 39 '9'
              00110001 31 '1'
DATA NAME   01100001 61 'a'
              0mmmmmmmm mh 0-15(Automix no.1-16), 256(Current data)
              0mmmmmmmm ml
EOX         11110111 F7 End of exclusive

```

### 2.12.2.35 Plug-in effect card bulk dump format

The second byte of the DATA NAME indicates the slot number.  
0:SLOT 1 – 1:SLOT 2

The data is not received if the Developer ID and Product ID are different than the card that is installed in the slot.

The data is not transmitted if a valid plug-in effect card is not installed.

```

STATUS      11110000 F0 System exclusive message
ID No.      01000011 43 Manufacture's ID number (YAMAHA)
SUB STATUS  0000nnnn 0n n=0-15 (Device number=MIDI Channel)
FORMAT No.  01111110 7E Universal bulk dump
COUNT HIGH 0ccccccc ch data count = ch * 128 + cl
COUNT LOW  0ccccccc cl
              01001100 4C 'L'
              01001101 4D 'M'
              00100000 20 ''
              00100000 20 ''
              00111000 38 '8'
              01000011 43 'C'
              00111001 39 '9'
              00110001 31 '1'

```

```

DATA NAME   01001110 4E 'N'
              0mmmmmmmm mh m=0-1(SLOT 1-2)
              0mmmmmmmm ml
BLOCK INFO  0bbbbbbb bh current block number(0-total block number)
              0bbbbbbb bl
              0ttttttt th total block number(minimum number is 0)
              0ttttttt tl
              0000iiii 0i Developer id (High)
              0000iiii 0i Developer id (Low)
              0000jjjj 0j Product id (High)
              0000jjjj 0j Product id (Low)
DATA        0ddddd ds Plug-in Effect card memory data of block[bb]
              :
              0ddddd de
CHECK SUM   0eeeeeee ee ee=(Invert('L'+...+de)+1)&0x7F
EOX         11110111 F7 End of exclusive

```

### 2.12.2.36 Plug-in effect card bulk dump request format

The second and third bytes of the DATA NAME indicate the slot number. (See above)

```

STATUS      11110000 F0 System exclusive message
ID No.      01000011 43 Manufacture's ID number (YAMAHA)
SUB STATUS  0010nnnn 2n n=0-15 (Device number=MIDI Channel)
FORMAT No.  01111110 7E Universal bulk dump
              01001100 4C 'L'
              01001101 4D 'M'
              00100000 20 ''
              00100000 20 ''
              00111000 38 '8'
              01000011 43 'C'
              00111001 39 '9'
              00110001 31 '1'
DATA NAME   01001110 4E 'N'
              0mmmmmmmm mh m=0-1(SLOT 1-2)
              0mmmmmmmm ml
EOX         11110111 F7 End of exclusive

```

## 2.12.3 PARAMETER CHANGE

### 2.12.3.1 Basic behavior

#### Reception

If [Parameter change ECHO] is ON, these messages are echoed.

If [Parameter change RX] is ON and the [Rx CH] matches the Device Number included in the SUB STATUS, these messages are received. A specific parameter is controlled when a Parameter Change is received. When a Parameter Request is received, the current value of the specified parameter will be transmitted as a Parameter Change with the Device Number set to [Rx CH].

#### Transmission

If [Parameter change TX] is ON and you operate a parameter for which Control Change transmission is not enabled, a parameter change will be transmitted with [Tx CH] as the Device Number.

As a response to a Parameter Request, a parameter change will be transmitted with [Rx CH] as the Device Number.

### 2.12.3.1.1 Parameter change basic format

```

STATUS      11110000 F0 System exclusive message
ID No.      01000011 43 Manufacture's ID number (YAMAHA)
SUB STATUS  0001nnnn 1n n=0-15 (Device number=MIDI Channel)
GROUP ID    00111110 3E MODEL ID (digital mixer)
MODEL ID    00001100 0C DM1000
ADDRESS     0ttttttt tt Data type
              0eeeeeee ee Element no.
              (If 'ee' is 0, 'ee' is expanded to two bytes)
              0ppppppp pp Parameter no.
              0ccccccc cc Channel no.
DATA * )    0ddddd dd data
              :
              :
EOX         11110111 F7 End of exclusive

```

\* ) For parameters with a data size of 2 or more, data for that size will be transmitted.

**2.12.3.1.2 Parameter Change basic format (Universal format)**

STATUS	11110000	F0	System exclusive message
ID No.	01000011	43	Manufacture's ID number (YAMAHA)
SUB STATUS	0001nnnn	1n	n=0-15 (Device number=MIDI Channel)
GROUP ID	00111110	3E	MODEL ID (digital mixer)
MODEL ID	01111111	7F	Universal
ADDRESS	0ttttttt	tt	Data type
	0eeeeeee	ee	Element no. (If 'ee' is 0, 'ee' is expanded to two bytes)
	0ppppppp	pp	Parameter no.
	0ccccccc	cc	Channel no.
DATA *)	0ddddddd	dd	data
	:	:	
EOX	11110111	F7	End of exclusive

\*) For parameters with a data size of 2 or more, data for that size will be transmitted.

**2.12.3.1.3 Parameter request basic format**

STATUS	11110000	F0	System exclusive message
ID No.	01000011	43	Manufacture's ID number (YAMAHA)
SUB STATUS	0011nnnn	3n	n=0-15 (Device number=MIDI Channel)
GROUP ID	00111110	3E	MODEL ID (digital mixer)
MODEL ID	00001100	0C	DM1000
ADDRESS	0ttttttt	tt	Data type
	0eeeeeee	ee	Element no. (If 'ee' is 0, 'ee' is expanded to two bytes)
	0ppppppp	pp	Parameter no.
	0ccccccc	cc	Channel no.
EOX	11110111	F7	End of exclusive

**2.12.3.1.4 Parameter request basic format (Universal format)**

STATUS	11110000	F0	System exclusive message
ID No.	01000011	43	Manufacture's ID number (YAMAHA)
SUB STATUS	0011nnnn	3n	n=0-15 (Device number=MIDI Channel)
GROUP ID	00111110	3E	MODEL ID (digital mixer)
MODEL ID	01111111	7F	Universal
ADDRESS	0ttttttt	tt	Data type
	0eeeeeee	ee	Element no. (If 'ee' is 0, 'ee' is expanded to two bytes)
	0ppppppp	pp	Parameter no.
	0ccccccc	cc	Channel no.
EOX	11110111	F7	End of exclusive

**2.12.3.1.5 Parameter Address**

Consult your dealer for parameter address details.

**2.12.3.2 Parameter change (Edit buffer)**

STATUS	11110000	F0	System exclusive message
ID No.	01000011	43	Manufacture's ID number (YAMAHA)
SUB STATUS	0001nnnn	1n	n=0-15 (Device number=MIDI Channel)
GROUP ID	00111110	3E	MODEL ID (digital mixer)
MODEL ID	01111111	7F	Universal
ADDRESS	00000001	01	Edit Buffer
	0eeeeeee	ee	Element no. (If 'ee' is 0, 'ee' is expanded to two bytes)
	0ppppppp	pp	Parameter no.
	0ccccccc	cc	Channel no.
DATA	0ddddddd	dd	data
	:	:	
EOX	11110111	F7	End of exclusive

**2.12.3.3 Parameter request (Edit buffer)**

STATUS	11110000	F0	System exclusive message
ID No.	01000011	43	Manufacture's ID number (YAMAHA)
SUB STATUS	0011nnnn	3n	n=0-15 (Device number=MIDI Channel)
GROUP ID	00111110	3E	MODEL ID (digital mixer)
MODEL ID	01111111	7F	Universal
ADDRESS	00000001	01	Edit Buffer
	0eeeeeee	ee	Element no. (If 'ee' is 0, 'ee' is expanded to two bytes)
	0ppppppp	pp	Parameter no.
	0ccccccc	cc	Channel no.
EOX	11110111	F7	End of exclusive

**2.12.3.4 Parameter change (Patch data)**

STATUS	11110000	F0	System exclusive message
ID No.	01000011	43	Manufacture's ID number (YAMAHA)
SUB STATUS	0001nnnn	1n	n=0-15 (Device number=MIDI Channel)
GROUP ID	00111110	3E	MODEL ID (digital mixer)
MODEL ID	00001100	0C	DM1000
ADDRESS	00000010	02	Patch data
	0eeeeeee	ee	Element no. (If 'ee' is 0, 'ee' is expanded to two bytes)
	0ppppppp	pp	Parameter no.
	0ccccccc	cc	Channel no.
DATA	0ddddddd	dd	data
	:	:	
EOX	11110111	F7	End of exclusive

**2.12.3.5 Parameter request (Patch data)**

STATUS	11110000	F0	System exclusive message
ID No.	01000011	43	Manufacture's ID number (YAMAHA)
SUB STATUS	0011nnnn	3n	n=0-15 (Device number=MIDI Channel)
GROUP ID	00111110	3E	MODEL ID (digital mixer)
MODEL ID	00001100	0C	DM1000
ADDRESS	00000010	02	Patch data
	0eeeeeee	ee	Element no. (If 'ee' is 0, 'ee' is expanded to two bytes)
	0ppppppp	pp	Parameter no.
	0ccccccc	cc	Channel no.
EOX	11110111	F7	End of exclusive

**2.12.3.6 Parameter change (Setup memory)**

STATUS	11110000	F0	System exclusive message
ID No.	01000011	43	Manufacture's ID number (YAMAHA)
SUB STATUS	0001nnnn	1n	n=0-15 (Device number=MIDI Channel)
GROUP ID	00111110	3E	MODEL ID (digital mixer)
MODEL ID	00001100	0C	DM1000
ADDRESS	00000011	03	Setup data
	0eeeeeee	ee	Element no. (If 'ee' is 0, 'ee' is expanded to two bytes)
	0ppppppp	pp	Parameter no.
	0ccccccc	cc	Channel no.
DATA	0ddddddd	dd	data
	:	:	
EOX	11110111	F7	End of exclusive

**2.12.3.7 Parameter request (Setup memory)**

STATUS	11110000	F0	System exclusive message
ID No.	01000011	43	Manufacture's ID number (YAMAHA)
SUB STATUS	0011nnnn	3n	n=0-15 (Device number=MIDI Channel)
GROUP ID	00111110	3E	MODEL ID (digital mixer)
MODEL ID	00001100	0C	DM1000
ADDRESS	00000011	03	Setup data
	0eeeeeee	ee	Element no. (If 'ee' is 0, 'ee' is expanded to two bytes)
	0ppppppp	pp	Parameter no.
	0ccccccc	cc	Channel no.
EOX	11110111	F7	End of exclusive

**2.12.3.8 Parameter change (Backup memory)**

```

STATUS      11110000 F0 System exclusive message
ID No.      01000011 43 Manufacture's ID number (YAMAHA)
SUB STATUS  0001nnnn 1n n=0-15 (Device number=MIDI Channel)
GROUP ID    00111110 3E MODEL ID (digital mixer)
MODEL ID    00001100 0C DM1000
ADDRESS     00000100 04 Backup data
              0eeeeeee ee Element no.
              (If 'ee' is 0, 'ee' is expanded to two bytes)
              0pppppppp pp Parameter no.
              0ccccccc cc Channel no.
DATA        0ddddd dd data
              :
              :
EOX         11110111 F7 End of exclusive
    
```

**2.12.3.9 Parameter request (Backup memory)**

```

STATUS      11110000 F0 System exclusive message
ID No.      01000011 43 Manufacture's ID number (YAMAHA)
SUB STATUS  0011nnnn 3n n=0-15 (Device number=MIDI Channel)
GROUP ID    00111110 3E MODEL ID (digital mixer)
MODEL ID    00001100 0C DM1000
ADDRESS     00000100 04 Backup data
              0eeeeeee ee Element no.
              (If 'ee' is 0, 'ee' is expanded to two bytes)
              0pppppppp pp Parameter no.
              0ccccccc cc Channel no.
EOX         11110111 F7 End of exclusive
    
```

**2.12.3.10 Parameter change (Cascade data)**

**Reception**

This message is echoed if [Parameter change ECHO] is ON.  
 Data received from a port that is assigned to [Cascade Link] and whose Device Number included in the SUB STATUS matches the [Rx CH] will be received for processing.

When this is received, the specified parameter will be controlled.

```

STATUS      11110000 F0 System exclusive message
ID No.      01000011 43 Manufacture's ID number (YAMAHA)
SUB STATUS  0001nnnn 1n n=0-15 (Device number=MIDI Channel)
GROUP ID    00111110 3E MODEL ID (digital mixer)
MODEL ID    01111111 7F Universal
ADDRESS     00001111 0F Cascade data
              0sssssss ss Set:0, Response:1
              0eeeeeee ee Element no.
              (If 'ee' is 0, 'ee' is expanded to two bytes)
              0pppppppp pp Parameter no.
              0ccccccc cc Channel no.
DATA        0ddddd dd data
              :
              :
EOX         11110111 F7 End of exclusive
    
```

**2.12.3.11 Parameter request (Cascade data)**

**Reception**

This message is echoed if [Parameter change ECHO] is ON.  
 Data received from a port that is assigned to [Cascade Link] and whose Device Number included in the SUB STATUS matches the [Rx CH] will be received for processing.

When this is received, the value of the specified parameter will be transmitted as a Parameter response.

```

STATUS      11110000 F0 System exclusive message
ID No.      01000011 43 Manufacture's ID number (YAMAHA)
SUB STATUS  0011nnnn 3n n=0-15 (Device number=MIDI Channel)
GROUP ID    00111110 3E MODEL ID (digital mixer)
MODEL ID    01111111 7F Universal
ADDRESS     00001111 0F Cascade data
              0eeeeeee ee Element no.
              (If 'ee' is 0, 'ee' is expanded to two bytes)
              0pppppppp pp Parameter no.
              0ccccccc cc Channel no.
EOX         11110111 F7 End of exclusive
    
```

**2.12.3.12 Parameter change (Function call: Library store / recall)**

**Reception**

When this is received, the specified memory/library will be stored/recalled. If this is received from Studio Manager or Cascade Link, the operation will be executed, and then the result of execution will be transmitted as a Parameter Response.

**Transmission**

If [Parameter change Tx] is ON, and you store or recall a memory/library for which Program Change transmission is not valid, this message will be transmitted with the Device Number set to the [Tx CH].

```

STATUS      11110000 F0 System exclusive message
ID No.      01000011 43 Manufacture's ID number (YAMAHA)
SUB STATUS  0001nnnn 1n n=0-15 (Device number=MIDI Channel)
GROUP ID    00111110 3E MODEL ID (digital mixer)
MODEL ID    01111111 7F Universal
ADDRESS     00010000 10 Function call
              0ffffff fff function
              0mmmmmmm mh number High
              0mmmmmmm ml number Low
DATA        0ccccccc ch channel High
              0ccccccc cl channel Low
EOX         11110111 F7 End of exclusive
    
```

function		number	channel*1)	tx/rx
SCENE RECALL	0x00	0-99, 8192	256	tx/rx
EQ LIB RECALL	0x01	1-128, 8192	0-513	tx/rx
GATE LIB RECALL	0x02	1-128, 8192	0-95	tx/rx
COMP LIB RECALL	0x03	1-128, 8192	0-513	tx/rx
EFF LIB RECALL	0x04	1-128, 8192	0-3	tx/rx
CHANNEL LIB RECALL	0x06	0-128, 8192	0-513	tx/rx
INPATCH LIB RECALL	0x07	0-32, 8192	256	tx/rx
OUTPATCH LIB RECALL	0x08	0-32, 8192	256	tx/rx
Bus to Stereo LIB RECALL	0x09	0-32, 8192	256	tx/rx
Surround Monitor LIB RECALL	0x0A	0-32, 8192	256	tx/rx
AUTOMIX LIB RECALL	0x0B	1-16	256	tx/rx
SCENE STORE	0x20	1-99	256, 16383	tx/rx
EQ LIB STORE	0x21	41-128	0-513, 16383	tx/rx
GATE LIB STORE	0x22	5-128	0-47, 16383	tx/rx
COMP LIB STORE	0x23	37-128	0-513, 16383	tx/rx
EFF LIB STORE	0x24	53-128	0-3, 16383	tx/rx
CHANNEL LIB STORE	0x26	1-128	0-513, 16383	tx/rx
INPATCH LIB STORE	0x27	1-32	256, 16383	tx/rx
OUTPATCH LIB STORE	0x28	1-32	256, 16383	tx/rx
Bus to Stereo LIB STORE	0x29	1-32	256, 16383	tx/rx
Surround Monitor LIB STORE	0x2A	1-32	256, 16383	tx/rx
AUTOMIX LIB STORE	0x2B	1-16	256, 16383	tx/rx

\*1) 0:CH1 – 47:CH48, 128:BUS1 – 135:BUS8, 256:AUX1 – 263:AUX8, 512:STEREO

Use 256 if the recall destination or store source is a single data item. Effect is 0:Effect 1–3:Effect 4

If the store destination is 16383 (0x3FFF), this indicates that the library data has been changed by an external cause (such as bulk reception) (only transmitted by the DM1000)

**2.12.3.12.1 Parameter change (Function call response: Library store/recall)**

**Transmission**

If store/recall is executed by a parameter change received from Studio Manager, the result of execution is transmitted as the following parameter change.

```

STATUS      11110000 F0 System exclusive message
ID No.      01000011 43 Manufacture's ID number (YAMAHA)
SUB STATUS  0001nnnn 1n n=0-15 (Device number=MIDI Channel)
GROUP ID    00111110 3E MODEL ID (digital mixer)
MODEL ID    01111111 7F Universal
ADDRESS     01010000 50 Function call response
              0ffffff fff function
              0mmmmmmm mh number High
              0mmmmmmm ml number Low
DATA        0ccccccc ch channel High
              0ccccccc cl channel Low
    
```

```

00000000 ee result HH
00000000 ee result HL
00000000 ee result LH
00000000 ee result LL
EOX      11110111 F7 End of exclusive
    
```

**2.12.3.13 Parameter change (Function call: title)**

**Reception**

When this is received, the title of the specified memory/library will be changed. If this is received from Studio Manager or Cascade Link, the operation will be executed, and then the result of execution will be transmitted as a parameter response.

**Transmission**

In response to a request, this is transmitted with the device number set to the [Tx CH].

When the title is changed on the DM1000, this message will be transmitted with the device number set to [Tx CH].

```

STATUS      11110000 F0 System exclusive message
ID No.      01000011 43 Manufacture's ID number (YAMAHA)
SUB STATUS  0001nnnn 1n n=0-15 (Device number=MIDI Channel)
GROUP ID    00111110 3E MODEL ID (digital mixer)
MODEL ID    01111111 7F Universal
ADDRESS     00010000 10 Function call
             0100ffff 4f title
             0mmmmmmmm mh number High
             0mmmmmmmm ml number Low
DATA        0d000000 dd title 1
             :           :
             0d000000 dd title x(depend on the library)
EOX         11110111 F7 End of exclusive
    
```

function	number	size
SCENE LIB TITLE	0x40	0-99,256(0:response only) 16
EQ LIB TITLE	0x41	1-128(1-40:response only) 16
GATE LIB TITLE	0x42	1-128(1-4:response only) 16
COMP LIB TITLE	0x43	1-128(1-36:response only) 16
EFF LIB TITLE	0x44	1-128(1-52:response only) 16
CHANNEL LIB TITLE	0x46	0-128(0:response only) 16
INPATCH LIB TITLE	0x47	0-32(0:response only) 16
OUTPATCH LIB TITLE	0x48	0-32(0:response only) 16
Bus to Stereo LIB TITLE	0x49	0-32(0:response only) 16
Surround Monitor LIB TITLE	0x4A	0-32(0:response only) 16
AUTOMIX LIB TITLE	0x4B	1-16 16

**2.12.3.14 Parameter request (Function call: title)**

**Reception**

When this is received, a parameter change will be transmitted with the device number set to [Rx CH].

Refer to the above table for the Functions and Numbers.

```

STATUS      11110000 F0 System exclusive message
ID No.      01000011 43 Manufacture's ID number (YAMAHA)
SUB STATUS  0011nnnn 3n n=0-15 (Device number=MIDI Channel)
GROUP ID    00111110 3E MODEL ID (digital mixer)
MODEL ID    01111111 7F Universal
ADDRESS     00010000 10 Function call
             0100ffff 4f title
             0mmmmmmmm mh number High
             0mmmmmmmm ml number Low
EOX         11110111 F7 End of exclusive
    
```

**2.12.3.15 Parameter change (Function call response: title)**

**Transmission**

If the title is modified by a parameter change received from Studio Manager, the result of execution will be transmitted as the following parameter change.

```

STATUS      11110000 F0 System exclusive message
ID No.      01000011 43 Manufacture's ID number (YAMAHA)
SUB STATUS  0001nnnn 1n n=0-15 (Device number=MIDI Channel)
GROUP ID    00111110 3E MODEL ID (digital mixer)
MODEL ID    01111111 7F Universal
ADDRESS     01010000 50 Function call
             0100ffff 4f title
    
```

```

0mmmmmmmm mh number High
0mmmmmmmm ml number Low
DATA        00000000 ee result HH
           00000000 ee result HL
           00000000 ee result LH
           00000000 ee result LL
EOX         11110111 F7 End of exclusive
    
```

**2.12.3.16 Parameter change (Function call: Scene/Library Clear)**

**Reception**

When this is received, the specified memory/library will be cleared. If this is received from Studio Manager or Cascade Link, the operation will be executed, and then the result of execution will be transmitted as the following parameter response.

**Transmission**

When a memory or library is cleared on the DM1000, this message will be transmitted with the device number set to [Tx CH].

```

STATUS      11110000 F0 System exclusive message
ID No.      01000011 43 Manufacture's ID number (YAMAHA)
SUB STATUS  0001nnnn 1n n=0-15 (Device number=MIDI Channel)
GROUP ID    00111110 3E MODEL ID (digital mixer)
MODEL ID    01111111 7F Universal
ADDRESS     00010000 10 Function call
             0110ffff 6f clear function
             0mmmmmmmm mh number High
             0mmmmmmmm ml number Low
EOX         11110111 F7 End of exclusive
    
```

function	number
SCENE LIB CLEAR	0x60 1-99
EQ LIB CLEAR	0x61 41-128
GATE LIB CLEAR	0x62 5-128
COMP LIB CLEAR	0x63 37-128
EFF LIB CLEAR	0x64 53-128
CHANNEL LIB CLEAR	0x66 1-128
INPATCH LIB CLEAR	0x67 1-32
OUTPATCH LIB CLEAR	0x68 1-32
Bus to Stereo LIB CLEAR	0x69 1-32
Surround Monitor LIB CLEAR	0x6A 1-32
AUTOMIX LIB CLEAR	0x6B 1-16

**2.12.3.17 Parameter change (Function call response: Scene/Library Clear)**

**Transmission**

When a scene or library is cleared as a result of receiving a parameter change from Studio Manager, the result of execution will be transmitted as the following parameter change.

```

STATUS      11110000 F0 System exclusive message
ID No.      01000011 43 Manufacture's ID number (YAMAHA)
SUB STATUS  0001nnnn 1n n=0-15 (Device number=MIDI Channel)
GROUP ID    00111110 3E MODEL ID (digital mixer)
MODEL ID    01111111 7F Universal
ADDRESS     01010000 50 Function call
             0110ffff 6f clear function
             0mmmmmmmm mh number High
             0mmmmmmmm ml number Low
DATA        00000000 ee result HH
           00000000 ee result HL
           00000000 ee result LH
           00000000 ee result LL
EOX         11110111 F7 End of exclusive
    
```

**2.12.3.18 Parameter change (Function call: attribute)**

**Reception**

This is received if [Parameter change RX] is ON and the [Rx CH] matches the device number included in the SUB STATUS. This is echoed if [Parameter change ECHO] is ON.

When this is received, the attribute of the specified memory/library will be changed.

**Transmission**

In response to a request, a Parameter Change message will be transmitted on the [Rx CH].  
If [Parameter change ECHO] is ON, this message will be retransmitted without change.

```

STATUS      11110000 F0 System exclusive message
ID No.      01000011 43 Manufacture's ID number (YAMAHA)
SUB STATUS  0001nnnn 1n n=0-15 (Device number=MIDI Channel)
GROUP ID    00111110 3E MODEL ID (digital mixer)
MODEL ID    01111111 7F Universal
ADDRESS     00010100 14 Function call
            0000ffff 0f attribute
            0mmmmmmmm mh number High
            0mmmmmmmm ml number Low
DATA        0ttttttt th attribute(protect:0x2000, normal:0x0000)
            0ttttttt tl
EOX         11110111 F7 End of exclusive
    
```

function	number
SCENE LIB ATTRIBUTE	0x00 0-99(0:response only)
EQ LIB ATTRIBUTE	0x01 1-128(1-40:response only)
GATE LIB ATTRIBUTE	0x02 1-128(1-4:response only)
COMP LIB ATTRIBUTE	0x03 1-128(1-36:response only)
EFF LIB ATTRIBUTE	0x04 1-128(1-52:response only)
CHANNEL LIB ATTRIBUTE	0x06 0-128(0:response only)
INPATCH LIB ATTRIBUTE	0x07 0-32(0:response only)
OUTPATCH LIB ATTRIBUTE	0x08 0-32(0:response only)
Bus to Stereo LIB ATTRIBUTE	0x09 0-32(0:response only)
Surround Monitor LIB ATTRIBUTE	0x0A 0-32(0:response only)
AUTOMIX LIB ATTRIBUTE	0x0B 1-16

**2.12.3.19 Parameter request (Function call: attribute)**

**Reception**

This is received if [Parameter change RX] is ON and the [Rx CH] matches the device number included in the SUB STATUS. This is echoed if [Parameter change ECHO] is ON.

When this is received, a Parameter Change message will be transmitted on the [Rx CH].

Refer to the above table for the Functions and Numbers.

```

STATUS      11110000 F0 System exclusive message
ID No.      01000011 43 Manufacture's ID number (YAMAHA)
SUB STATUS  0011nnnn 3n n=0-15 (Device number=MIDI Channel)
GROUP ID    00111110 3E MODEL ID (digital mixer)
MODEL ID    01111111 7F Universal
ADDRESS     00010100 14 Function call
            0000ffff 0f attribute
            0mmmmmmmm mh number High
            0mmmmmmmm ml number Low
EOX         11110111 F7 End of exclusive
    
```

**2.12.3.20 Parameter change (Function call response: attribute)**

**Transmission**

When an attribute is modified as a result of receiving a parameter change from Studio Manager, the result of execution will be transmitted as the following parameter change.

```

STATUS      11110000 F0 System exclusive message
ID No.      01000011 43 Manufacture's ID number (YAMAHA)
SUB STATUS  0001nnnn 1n n=0-15 (Device number=MIDI Channel)
GROUP ID    00111110 3E MODEL ID (digital mixer)
MODEL ID    01111111 7F Universal
ADDRESS     01010100 54 Function call
            0000ffff 0f attribute
            0mmmmmmmm mh number High
            0mmmmmmmm ml number Low
DATA        0eeeeeee ee result HH
            0eeeeeee ee result HL
            0eeeeeee ee result LH
            0eeeeeee ee result LL
EOX         11110111 F7 End of exclusive
    
```

**2.12.3.21 Parameter change (Function call: link)**

**Reception**

This is received if [Parameter change RX] is ON and the [Rx CH] matches the device number included in the SUB STATUS. This is echoed if [Parameter change ECHO] is ON.

When this is received, the patch link data of the specified scene will be modified.

**Transmission**

In response to a request, a Parameter Change message will be transmitted on the [Rx CH].

If [Parameter change ECHO] is ON, this message will be retransmitted without change.

```

STATUS      11110000 F0 System exclusive message
ID No.      01000011 43 Manufacture's ID number (YAMAHA)
SUB STATUS  0001nnnn 1n n=0-15 (Device number=MIDI Channel)
GROUP ID    00111110 3E MODEL ID (digital mixer)
MODEL ID    01111111 7F Universal
ADDRESS     00010100 14 Function call
            0010ffff 2f link
            0mmmmmmmm mh number High
            0mmmmmmmm ml number Low
DATA        0iiiiiii ih inpatch
            0iiiiiii il
            0ooooooo oh outpatch
            0ooooooo ol
EOX         11110111 F7 End of exclusive
    
```

function	number
SCENE LIB LINK	0x20 0-99(0:response only)

**2.12.3.22 Parameter request (Function call: link)**

**Reception**

This is received if [Parameter change RX] is ON and the [Rx CH] matches the device number included in the SUB STATUS. This is echoed if [Parameter change ECHO] is ON.

When this is received, a Parameter Change message will be transmitted on the [Rx CH].

Refer to the above table for the Functions and Numbers.

```

STATUS      11110000 F0 System exclusive message
ID No.      01000011 43 Manufacture's ID number (YAMAHA)
SUB STATUS  0011nnnn 3n n=0-15 (Device number=MIDI Channel)
GROUP ID    00111110 3E MODEL ID (digital mixer)
MODEL ID    01111111 7F Universal
ADDRESS     00010100 14 Function call
            0010ffff 2f link
            0mmmmmmmm mh number High
            0mmmmmmmm ml number Low
EOX         11110111 F7 End of exclusive
    
```

**2.12.3.23 Parameter change (Function call response: link)**

**Transmission**

When link data is modified as a result of receiving a parameter change from Studio Manager, the result of execution will be transmitted as the following parameter change.

```

STATUS      11110000 F0 System exclusive message
ID No.      01000011 43 Manufacture's ID number (YAMAHA)
SUB STATUS  0001nnnn 1n n=0-15 (Device number=MIDI Channel)
GROUP ID    00111110 3E MODEL ID (digital mixer)
MODEL ID    01111111 7F Universal
ADDRESS     01010100 54 Function call
            0010ffff 2f link
            0mmmmmmmm mh number High
            0mmmmmmmm ml number Low
DATA        0eeeeeee ee result HH
            0eeeeeee ee result HL
            0eeeeeee ee result LH
            0eeeeeee ee result LL
EOX         11110111 F7 End of exclusive
    
```

2.12.3.24 Parameter change (Function call: pair, copy)

Reception

This is received if [Parameter change RX] is ON and the [Rx CH] matches the device number included in the SUB STATUS. This is echoed if [Parameter change ECHO] is ON.

When this is received, pairing will be enabled/disabled for the specified channel.

```
STATUS 11110000 F0 System exclusive message
ID No. 01000011 43 Manufacture's ID number (YAMAHA)
SUB STATUS 0001nnnn 1n n=0-15 (Device number=MIDI Channel)
GROUP ID 00111110 3E MODEL ID (digital mixer)
MODEL ID 01111111 7F Universal
ADDRESS 00010001 11 Function call Pair
          0000ffff 0f function
          0sssssss sh Source channel H
          0sssssss sl Source channel L
DATA 00000000 dh Destination channel H
      00000000 dl Destination channel L
EOX 11110111 F7 End of exclusive
```

function		channel
PAIR ON with COPY	0x00	*1)
PAIR ON with RESET BOTH	0x01	*1)
PAIR OFF	0x02	*1)

- \*1) 0:CH1 – 47:CH48, 128:BUS1 – 135:BUS8, 256:AUX1 – 263:AUX8, 512:STEREO  
Effect is 0:Effect 1–3:Effect 4
- In the case of PAIR, you must specify channels for which pairing is possible.
- In the case of PAIR ON with COPY, you must specify Source Channel as the copy source, and Destination Channel as the copy destination.

2.12.3.25 Parameter change (Function call Event: Effect )

Reception

This is received if [Parameter change RX] is ON and the [Rx CH] matches the device number included in the SUB STATUS.

This is echoed if [Parameter change ECHO] is ON.

When this is received, the corresponding effect's function activates (depending on the effect type).

```
STATUS 11110000 F0 System exclusive message
ID No. 01000011 43 Manufacture's ID number (YAMAHA)
SUB STATUS 0001nnnn 1n n=0-15 (Device number=MIDI Channel)
GROUP ID 00111110 3E MODEL ID (digital mixer)
MODEL ID 01111111 7F Universal
ADDRESS 00010010 12 Function call Effect Event
          0000ffff 0f function
          00000000 00
          0ppppppp pp Release:0, Press:1
DATA 00000000 00
      00000000 00
      00000000 00
EOX 11110111 F7 End of exclusive
```

function		channel
Freeze Play button	0x00	0:Effect1-3:Effect4
Freeze Record button	0x01	0:Effect1-3:Effect4
Auto Pan 5.1 Trigger Button	0x02	0:Effect1-3:Effect4
Auto Pan 5.1 Reset Button	0x03	0:Effect1-3:Effect4

- This does not activate when the effect type is different.

2.12.3.26 Parameter change (Sort Table)

When scene memory sort is executed on the DM1000, the memory sort table will be transmitted to Studio Manager.

Studio Manager will sort the memories according to this data.

If Studio Manager performs a scene memory sort, it will transmit this data to the DM1000.

```
STATUS 11110000 F0 System exclusive message
ID No. 01000011 43 Manufacture's ID number (YAMAHA)
SUB STATUS 0001nnnn 1n n=0-15 (Device number=MIDI Channel)
GROUP ID 00111110 3E MODEL ID (digital mixer)
MODEL ID 00001100 0C DM1000
ADDRESS 00010011 13 Library sort table
          0000ffff 0f Library type
DATA 00000000 ds Data
      : :
```

```
00000000 de Data
EOX 11110111 F7 End of exclusive
```

8-7 conversion is performed on the data area in the same way as for bulk.

2.12.3.27 Parameter request (Sort Table)

When the DM1000 receives this data, it will transmit Sort Table Data.

```
STATUS 11110000 F0 System exclusive message
ID No. 01000011 43 Manufacture's ID number (YAMAHA)
SUB STATUS 0011nnnn 3n n=0-15 (Device number=MIDI Channel)
GROUP ID 00111110 3E MODEL ID (digital mixer)
MODEL ID 00001100 0C DM1000
ADDRESS 00010011 13 Library sort table
          0000ffff 0f Library type
EOX 11110111 F7 End of exclusive
```

2.12.3.28 Parameter change (Key remote)

Reception

This is received if [Parameter change RX] is ON and the [Rx CH] matches the device number included in the SUB STATUS.

This is echoed if [Parameter change ECHO] is ON.

When this is received, the same processing that is executed when the key specified by Address is pressed (released).

Transmission

If [Parameter Change ECHO] is ON, this message is retransmitted without change.

```
STATUS 11110000 F0 System exclusive message
ID No. 01000011 43 Manufacture's ID number (YAMAHA)
SUB STATUS 0001nnnn 1n n=0-15 (Device number=MIDI Channel)
GROUP ID 00111110 3E MODEL ID (digital mixer)
MODEL ID 00001100 0C DM1000
ADDRESS 00100000 20 Key remote
          0kkkkkkk kk Key address H
          0kkkkkkk kk Key address M
          0kkkkkkk kk Key address L
DATA 0ppppppp pp Release:0, Press:1
EOX 11110111 F7 End of exclusive
```

2.12.3.29 Parameter change (Remote Meter)

When transmission is enabled by receiving a Request of Remote meter, the specified meter information is transmitted every 50 msec for 10 seconds. When you want to transmit meter information continuously, a Request must be transmitted continuously within every 10 seconds.

Reception

This is echoed if [Parameter change ECHO] is ON.

Transmission

When transmission has been enabled by a Request, the parameter specified by Address will be transmitted on the [Rx CH] channel at 50 msec intervals for a duration of 10 seconds.

Transmission will be disabled if the power is turned off and on again, or if the PORT setting is changed.

If [Parameter Change ECHO] is ON, this message is retransmitted without change.

```
STATUS 11110000 F0 System exclusive message
ID No. 01000011 43 Manufacture's ID number (YAMAHA)
SUB STATUS 0001nnnn 1n n=0-15 (Device number=MIDI Channel)
GROUP ID 00111110 3E MODEL ID (digital mixer)
MODEL ID 00001100 0C DM1000
ADDRESS 00100001 21 Remote meter
          0mmmmmmm mm ADDRESS UL
          0mmmmmmm mm ADDRESS LU
          0mmmmmmm mm ADDRESS LL
DATA 00000000 dd Data1 H
      00000000 dd Data1 L
      : :
EOX 11110111 F7 End of exclusive
```

- \* The meter data can be either the unadjusted DECAY value of the DSP, or the table-converted value. The interpretation of the data will depend on the parameter.

### 2.12.3.30 Parameter request (Remote Meter)

#### Reception

This is received if [Parameter change RX] is ON and the [Rx CH] matches the device number included in the SUB STATUS. This is echoed if [Parameter change ECHO] is ON.

When this is received, data of the specified address is transmitted on the [Rx CH] at intervals of 50 msec as a rule (although this may not be the case if the port is being used by other communication), for a period of 10 seconds.

If Address UL= 0x7F is received, transmission of all meter data will be halted immediately. (disable)

#### Transmission

If [Parameter Change ECHO] is ON, this message is retransmitted without change.

STATUS	11110000	F0	System exclusive message
ID No.	01000011	43	Manufacture's ID number (YAMAHA)
SUB STATUS	0011nnnn	3n	n=0-15 (Device number=MIDI Channel)
GROUP ID	00111110	3E	MODEL ID (digital mixer)
MODEL ID	00001100	0C	DM1000
ADDRESS	00100001	21	Remote meter
	0mmmmmmmm	mm	ADDRESS UL
	0mmmmmmmm	mm	ADDRESS LU
	0mmmmmmmm	mm	ADDRESS LL
	0ccccccc	ch	Count H
	0ccccccc	cl	Count L
EOX	11110111	F7	End of exclusive

### 2.12.3.31 Parameter change (Remote Time Counter)

When transmission is enabled by receiving a Request of Remote Time Counter, the Time Counter data is transmitted every 50 msec for 10 seconds. When you want to transmit Counter information continuously, a Request must be transmitted within every 10 seconds.

#### Reception

This is echoed if [Parameter change ECHO] is ON.

#### Transmission

When transmission is enabled by receiving a Request, the Time Counter information is transmitted on [RxCH] channel every 50 msec for 10 seconds. Transmission will be disabled if the power is turned off and on again, or if the PORT setting is changed.

If [Parameter Change ECHO] is ON, this message is retransmitted without change.

STATUS	11110000	F0	System exclusive message
ID No.	01000011	43	Manufacture's ID number (YAMAHA)
SUB STATUS	0001nnnn	1n	n=0-15 (Device number=MIDI Channel)
GROUP ID	00111110	3E	MODEL ID (digital mixer)
MODEL ID	00001100	0C	DM1000
ADDRESS	00100010	22	Remote Time counter
	0000tttt	0t	0:Time code, 1:Measure.Beat.Clock
	0ddddd	dd	Hour / Measure H
	0ddddd	dd	Minute / Measure L
DATA	0ddddd	dd	Second / Beat
	0ddddd	dd	Frame / Clock
EOX	11110111	F7	End of exclusive

### 2.12.3.32 Parameter request (Remote Time Counter)

#### Reception

This is received if [Parameter change RX] is ON and the [Rx CH] matches the device number included in the SUB STATUS. This is echoed if [Parameter change ECHO] is ON.

When this is received, the Time Counter information is transmitted on the [Rx CH] channel every 50 msec for 10 seconds.

When the second byte of Address is received on 0x7F, data transmission will be halted immediately. (disable)

#### Transmission

If [Parameter Change ECHO] is ON, this message is retransmitted without change.

STATUS	11110000	F0	System exclusive message
ID No.	01000011	43	Manufacture's ID number (YAMAHA)
SUB STATUS	0011nnnn	3n	n=0-15 (Device number=MIDI Channel)
GROUP ID	00111110	3E	MODEL ID (digital mixer)
MODEL ID	00001100	0C	DM1000
ADDRESS	00100010	22	Remote Time counter
	0ddddd	dd	0:Transmission request, 0x7F:Transmission stop request
EOX	11110111	F7	End of exclusive

### 2.12.3.33 Parameter change (Automix Status)

When transmission is enabled by receiving a Request of Automix status, the Automix Status data is transmitted every second for 10 seconds. When you want to transmit the Automix Status information continuously, the Request must be transmitted continuously minimum within 10 seconds interval. The data is transmitted continuously while the transmission is enabled, even when the Automix Status on the DM1000 has been changed.

#### Reception

This is echoed if [Parameter change ECHO] is ON.

#### Transmission

When the transmission is set to enable by receiving a Request. The Automix Status data is transmitted on the [Rx CH] channel every second for 10 seconds. The data is transmitted continuously while the transmission is enabled, even when the Automix Status on the DM1000 has been changed.

Transmission will be disabled if the power is turned off and on again, or if the PORT setting is changed.

If [Parameter Change ECHO] is ON, this message is retransmitted without change.

STATUS	11110000	F0	System exclusive message
ID No.	01000011	43	Manufacture's ID number (YAMAHA)
SUB STATUS	0001nnnn	1n	n=0-15 (Device number=MIDI Channel)
GROUP ID	00111110	3E	MODEL ID (digital mixer)
MODEL ID	00001100	0C	DM1000
ADDRESS	00100011	23	Automix status
	00000000	00	
	0000ddd	0d	Automix status H
	0000ddd	0d	Automix status L
EOX	11110111	F7	End of exclusive

### 2.12.3.34 Parameter request (Automix Status)

#### Reception

This is received if [Parameter change RX] is ON and the [Rx CH] matches the device number included in the SUB STATUS.

This is echoed if [Parameter change ECHO] is ON.

When the data is received, the Automix Status data is transmitted on the [Rx CH] every second for 10 seconds.

When the second byte of Address is received on 0x7F, data transmission will be halted immediately (disable).

#### Transmission

If [Parameter Change ECHO] is ON, this message is retransmitted without change.

STATUS	11110000	F0	System exclusive message
ID No.	01000011	43	Manufacture's ID number (YAMAHA)
SUB STATUS	0011nnnn	3n	n=0-15 (Device number=MIDI Channel)
GROUP ID	00111110	3E	MODEL ID (digital mixer)
MODEL ID	00001100	0C	DM1000
ADDRESS	00100011	23	Automix status
	0ddddd	dd	0:Transmission request, 0x7F:Transmission stop request
EOX	11110111	F7	End of exclusive

# Appendix D: About Optional Product

## MB1000 Peak Meter Bridge

### Installing the Meter Bridge

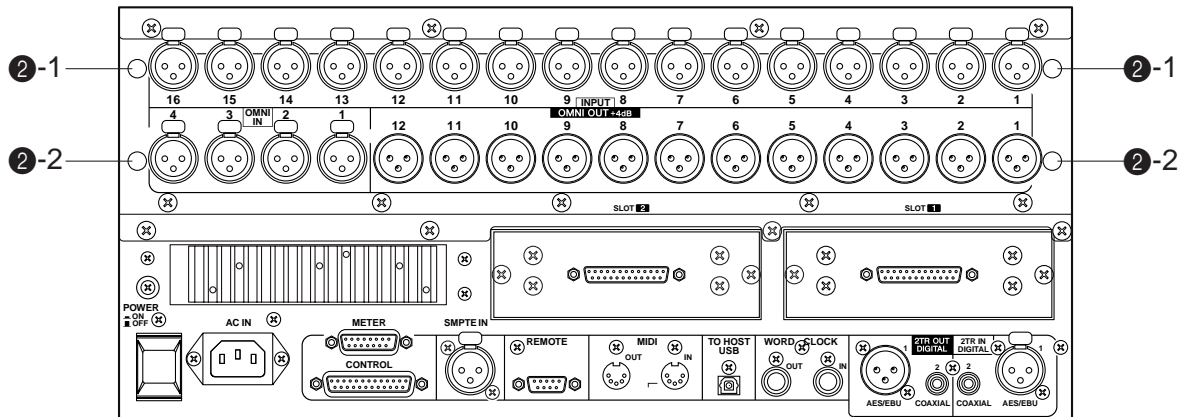

**1 Attach the brackets to the meter bridge.**

Align the holes on the lower part of the meter bridge with the holes on the upper part of the brackets (as shown in the illustration below), then use four 8 mm screws (1) included in the MB1000 package to affix the brackets to the meter bridge.

**2 Install the meter bridge to the DM1000 following the steps below:**

- a) Insert two of four 12 mm screws (2-2) included in the MB1000 package into the lower holes (2-2), then tighten them with your fingers. Leave the screws projecting by about 4 mm.
- b) Align these screws with the notches on the included meter angles, then align the holes on the upper part of the meter angles with the holes on the upper part of the DM1000 (2-1).
- c) Insert the other two 12 mm screws (2-1) into the upper holes (2-1), then tighten them securely.
- d) Tighten the screws (2-2) that were finger-tightened in Step a) securely to firmly attach the meter bridge to the DM1000.

**3 Connect the meter bridge cable to the DM1000's METER connector.**

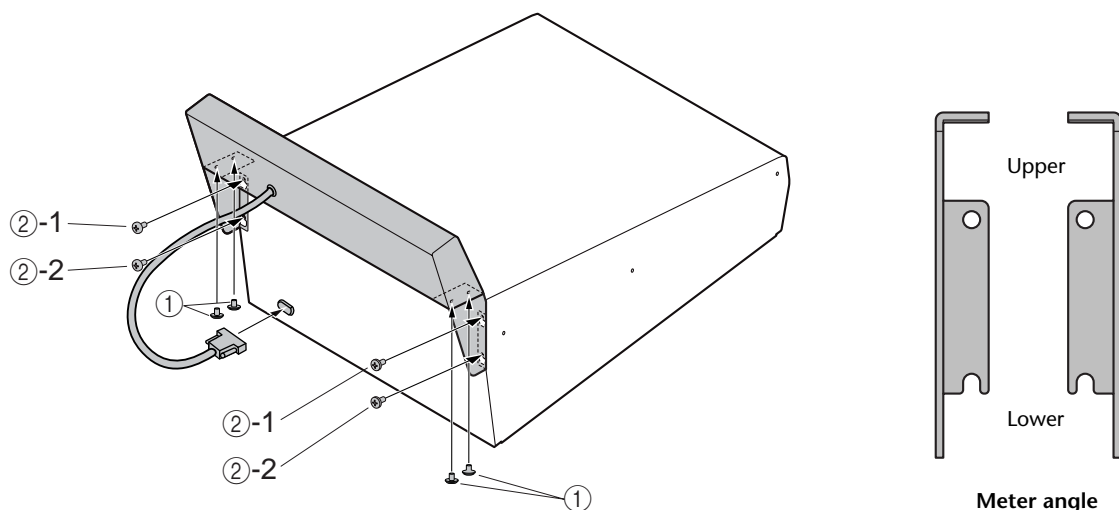



## Meter Bridge Controls

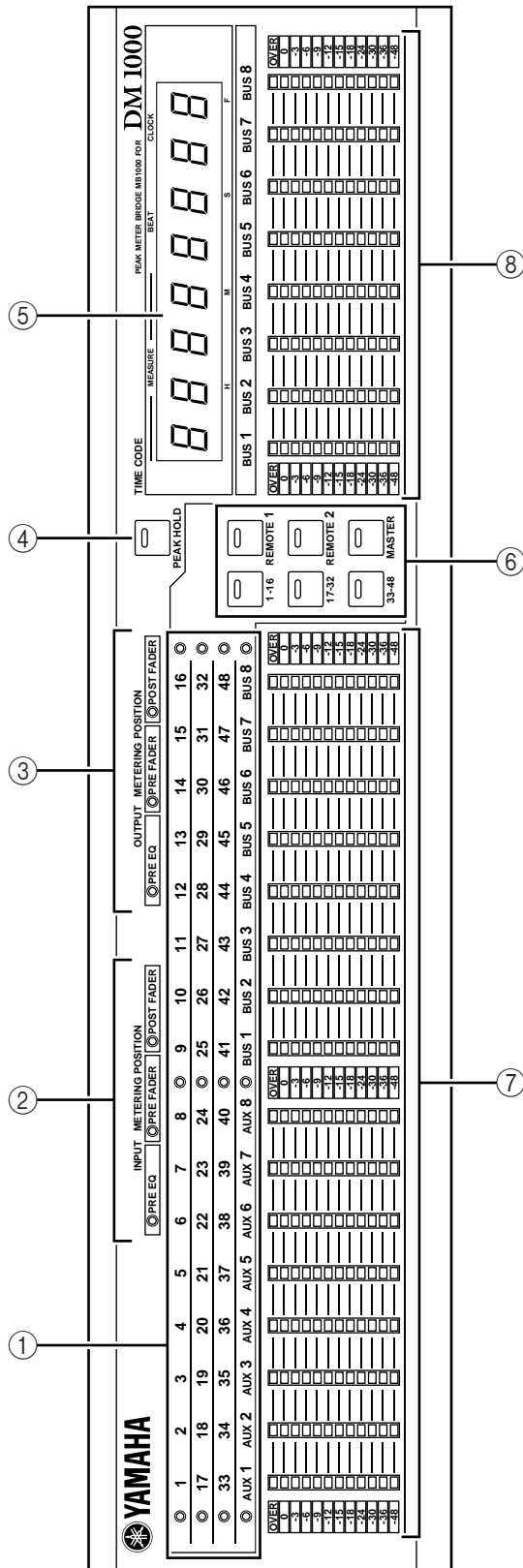

- ① **Channel indicators**  
These indicators display the channels for which the levels are currently displayed (Input Channels 1-16, 17-32, 33-48, Aux Outs 1-8, Bus Outs 1-8).
- ② **INPUT METERING POSITION indicators**  
These indicators display the current metering position specified for the Input Channels.
- ③ **OUTPUT METERING POSITION indicators**  
These indicators display the current metering position specified for the Output Channels.
- ④ **[PEAK HOLD] button**  
This button turns the Peak Hold function on or off. When the Peak Hold function is turned on, the button indicator lights up. This button works in unison with the PEAK HOLD button displayed on the Meter display.
- ⑤ **TIME CODE display**  
This display indicates the timecode or MIDI clock value the DM1000 is receiving or generating.
- ⑥ **[1-16] / [17-32] / [33-48] / [REMOTE 1] / [REMOTE 2] / [MASTER] buttons**  
These buttons select the layers of the channel meters displayed on the meter bridge. The button indicator of the currently-selected layer lights up.  
  
If you turn on the Meter Follow Layer check box on the Setup | Prefer1 page (see page 250), the layer selection on the meter bridge follows the layer selection on the DM1000.
- ⑦ **Level meters**  
These 12-segment LED level meters display the channel levels of the selected layer.
- ⑧ **Bus meters**  
These 12-segment LED meters display the signal levels of Bus Outs 1-8.

## Rack Mounting the MB1000 Using Rack Angle Brackets

You can rack mount the MB1000 meter bridge using the rack angle brackets that came with the meter bridge.

- 1 Detach the MB1000 from the DM1000. Also, remove the SP1000 side panels if they are attached.
- 2 Hold a rack bracket against one side of the meter bridge so that the rack angle bracket ear projects to the side, and align two holes on the brackets with the holes on the side of the meter bridge, as shown in the illustration below.
- 3 Affix the bracket using the screws included in the meter bridge package.
- 4 Attach the other bracket to the other side of the MB1000 in the same way.

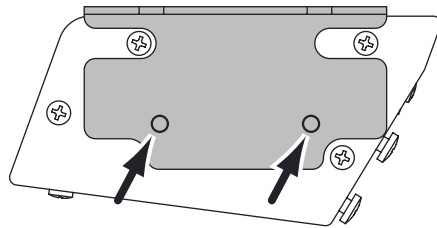

Side of Meter Bridge

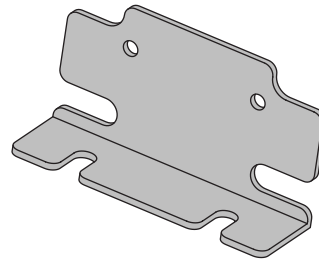

Rack angle bracket

## Installing the SP1000 Side Panels

The figure below illustrates how to attach the left side panel to the DM1000. Attach the right side panel to the DM1000 in the same way.

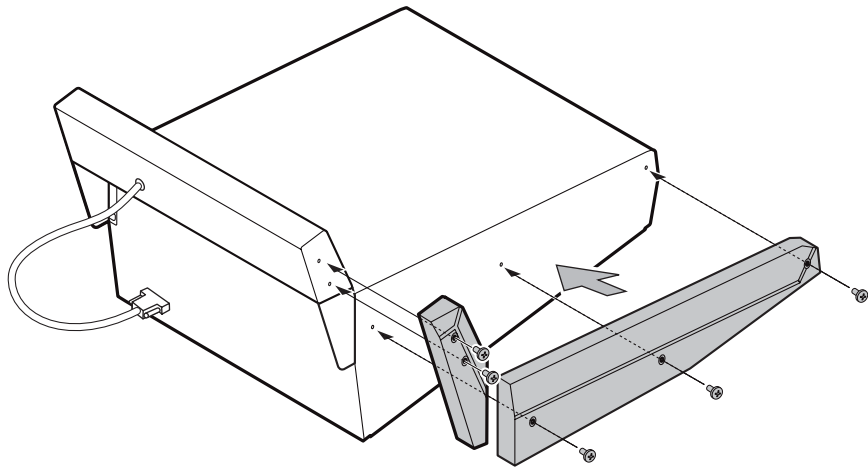

## Rack Mounting the DM1000 Using the RK1 Rack Mount Kit

You can rack mount the DM1000 using the optional RK1 Rack Mount Kit.

- 1 Remove the side panels if they are attached.
- 2 Hold one of the brackets against one side of the DM1000 so that the bracket ear projects to the side, and align five holes on the bracket with the holes on the side of the DM1000, as shown in the illustration below.
- 3 Affix the bracket using five screws included in the RK1 package.
- 4 Attach the other bracket to the other side of the DM1000 in the same way.

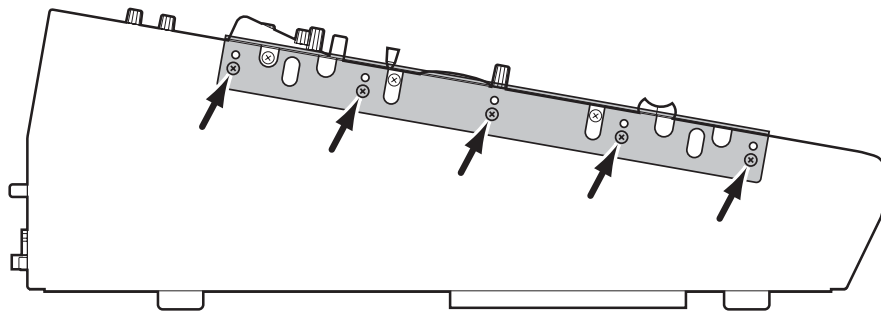

**Caution:** Do not rack mount the DM1000 and an MB1000 connected together as a unit. Be sure to rack mount them separately using the dedicated brackets.

# Index

## Symbols

ø/INS/DLY   DLY 1-16 page .....	61
ø/INS/DLY   DLY 17-32 page .....	61
ø/INS/DLY   DLY 33-48 page .....	61
ø/INS/DLY   Insert page .....	112
ø/Ins/Dly   Insert page .....	150
ø/INS/DLY   Out Dly page .....	81, 93
ø/INS/DLY   Phase page .....	60
ø/INSERT/DELAY button .....	17
+48V ON/OFF switches .....	14
Phantom power .....	51

## Numerics

1-12 buttons .....	21
1-16/17-32/33-48 buttons .....	20
2TR D1/D2 buttons .....	22
2TR IN D1/D2 buttons .....	53
2TR IN DIGITAL AES/EBU 1 .....	25
2TR IN DIGITAL COAXIAL 2 .....	25
2TR IN DIGITAL connectors .....	52
2TRD1/2 .....	46
2TR OUT DIGITAL AES/EBU 1 .....	25
2TR OUT DIGITAL COAXIAL 2 .....	25
2TR OUT DIGITAL connectors .....	52
2TRD1/2 .....	46

## A

ABORT .....	194
About the display .....	27
AC IN connector .....	25
AD input .....	14
AD input and output section .....	23
AD Input section .....	51
AD824 .....	270
AD824 GAIN/PHANTOM CONTROL .....	271
ADAT I/O card .....	53
AES/EBU I/O card .....	53
AMP SIMULATE .....	300
Analog inputs & outputs .....	51
ASSIGN button .....	16
Assignable parameters .....	36
Assigne	
Control changes .....	240
MIDI messages .....	228
Parameters to the encoder .....	35
Program changes .....	239
Remote layer .....	205
USER DEFINED KEYS .....	214
Attenuator .....	64, 81, 92
Output signals .....	88
AUTO button .....	15
Auto Channel Select preference .....	251
Auto Direct Out On preference .....	252
Auto EQ Edit in preference .....	254
Auto EQUALIZER Display preference .....	251
Auto Inc TC Capture preference .....	254
AUTO PAN .....	296

AUTO PAN 5.1 .....	311
Auto PAN/SURROUND Display preference .....	251
AUTO REC .....	194
Auto ROUTING Display preference .....	250
Auto SOLO Display preference .....	251
Auto update function .....	159
Auto WORD CLOCK Display preference .....	251
Automix .....	181
ABORT .....	194
ABSOLUTE .....	193
AUTO button .....	15, 190
AUTO REC .....	194
AUTOMIX button .....	17
Automix main page .....	191
Automix memory page .....	195
COPY .....	199
EDIT OUT .....	192, 197
Edit safe buttons .....	197
Editing events offline .....	198
ERASE .....	199
Event edit page .....	202
Event job page .....	198
FADER EDIT .....	193
Fader Edit mode .....	192
Fader1 & 2 pages .....	196
FRAMES .....	182
INT START TIME .....	191
MOTOR .....	196
MOVE/MERGE .....	199
NEW .....	194
OFFSET .....	191
OVERWRITE .....	194
Parameter events can be recorded .....	181
PLAY .....	194
Playing back .....	190
PROTECT .....	196
Punching in & out .....	188
REC .....	194
Recording .....	184
Recording the event .....	185
RELATIVE .....	193
RETURN .....	192
SEL button .....	190
Setting up .....	182
Setup   Time Sig page .....	183
STOP .....	194
TAKEOVER .....	192
TIME REFERENCE .....	191
TIME REFERENCE section .....	182
Time signature map .....	183
Timecode source .....	182
TO END button .....	191
TRIM .....	200
UPDATE .....	191
Automix   Event Edit page .....	202
Automix   Event Job page .....	198
Automix   Fader1 or 2 page .....	196
Automix   Main page .....	184, 191
Automix   Memory page .....	195
AUTOMIX button .....	17

Automix main page .....	191
Automix memory page .....	195
Automix Store Undo preference .....	254
AUX 1-AUX 8 buttons .....	16
AUX button .....	16
AUX indicator .....	16, 33
AUX SELECT section .....	16
Aux send mode .....	97, 98, 101
Aux sends .....	91, 96
Attenuating .....	92
Comp settings .....	93
Copying channel fader positions .....	104
Delaying .....	93
EQ settings .....	92, 94
Excluding certain channels .....	103
Fixed mode .....	98
Mix minus .....	103
Panning .....	102
Setting from the control surface .....	92
Setting from the display .....	92, 97
Setting levels .....	92
Variable mode .....	98
Viewing settings .....	94
Viewing settings for multiple channels .....	100
Aux1   Pan1-32 page .....	102
Aux1   Pan33-48 page .....	102
Aux1   Send1-32 page .....	71, 97
Aux1   Send33-48 page .....	97
Aux1   View1-16 page .....	100
Aux1   View17-32 page .....	100
Aux1   View33-48 page .....	100

## B

Bass Management .....	134
Battery .....	272
Bulk dump .....	246
Messages .....	235
BUS button .....	22, 132
Bus out .....	79
Attenuating .....	81
Compressing .....	82
Delaying .....	81
EQ'ing .....	82, 86
Naming .....	89
Pairing .....	87
Routing signals to the stereo bus .....	83
Setting from the control surface .....	86
Setting from the display .....	81
Setting the levels .....	86
Viewing the settings .....	84
Bus to stereo library .....	173
BUS1-BUS8 .....	125
Buttons .....	29

## C

Cascade COMM Link preference .....	252
Cascading consoles .....	265
Cascade page .....	268
Reverse cable .....	24
SYNC parameter .....	269

- CATEGORY ..... 55
- Changing names ..... 249
- Channel Copy Parameter  
  preference ..... 253
- Channel faders ..... 15
- Channel ID/Channel preference ..... 252
- Channel library ..... 167
- Channel strip section ..... 15
- CHORUS ..... 294
- CHORUS 5.1 ..... 311
- CLEAR button ..... 22
- Clear Edit Channel after REC  
  preference ..... 254
- COMP 5.1 ..... 314
- COMPAND 5.1 ..... 315
- Compressor library ..... 175  
  Preset ..... 175
- Compressors ..... 63, 82, 93  
  Compressor link ..... 141  
  DYNAMICS button ..... 18  
  Linking ..... 144  
  Parameter table ..... 329  
  Preset parameters ..... 320
- Confirmation messages ..... 30
- Connections ..... 41  
  Configuring a recording system  
    that uses a DAW ..... 43  
  Configuring a recording system  
    with a hard disk recorder ..... 42  
  Configuring an analog 32-channel  
    mixing system ..... 41
- Contrast control ..... 18
- Control changes ..... 235, 240
- CONTROL connector ..... 24
- CONTROL port pin assignments ..... 333
- CONTROL ROOM DIMMER  
  LEVEL ..... 117
- Control room monitor ..... 115
- Control surface ..... 13  
  AD input section ..... 14  
  AUX SELECT section ..... 16  
  Channel strip section ..... 15  
  Data entry section ..... 21  
  DISPLAY ACCESS section ..... 17  
  Display section ..... 18  
  ENCODER MODE section ..... 16  
  FADER MODE section ..... 16  
  Headphones & talkback section ..... 21  
  LAYER section ..... 20  
  MONITOR section ..... 22  
  SCENE MEMORY section ..... 20  
  SELECTED CHANNEL section ..... 19  
  STEREO section ..... 15  
  USER DEFINED KEYS section ..... 21
- COPY ..... 56
- Copy Initial Fader preference ..... 254
- Cursor buttons ..... 21
- D**
- Daisy chain distribution ..... 44
- Data entry section ..... 21
- DAW ..... 224  
  Nuendo ..... 224  
  Other ..... 224  
  Pro tools ..... 206  
  Recording system ..... 43  
  Remote ..... 205
- DEC & INC buttons ..... 21
- DEL button ..... 30
- Delay ..... 61, 81, 93  
  DELAY SCALE ..... 61  
  FB.GAIN ..... 62
- DELAY LCR ..... 293
- DELAY SCALE ..... 61
- DELAY+ER. .... 305
- DELAY+REV ..... 307
- DELAY->ER. .... 306
- DELAY->REV ..... 307
- Digital I/O & control section ..... 24
- Digital inputs & outputs ..... 52
- Dimensions ..... 334
- DIMMER button ..... 22
- DIO | Cascade page ..... 268
- DIO | Format page ..... 54, 56, 57
- DIO | Word Clock page ..... 45, 53
- DIO button ..... 17
- DIO Warning preference ..... 251
- Direct outs ..... 111
- Display ..... 18
- DISPLAY ACCESS section ..... 17
- Display Brightness preference ..... 253
- DISPLAY button ..... 16, 21, 22
- Display section ..... 18
- DIST->DELAY ..... 308
- DISTORTION ..... 299
- Dithering ..... 56
- DIV ..... 127
- DOUBLE CHANNEL ..... 57
- DOUBLE SPEED ..... 57
- Drop Out Time preference ..... 254
- DUAL PITCH ..... 298
- DYNA. FILTER ..... 300
- DYNA. FLANGE ..... 301
- DYNA. PHASER ..... 301
- Dynamics | Comp Edit page ..... 63, 82, 93
- Dynamics | Comp Lib page ..... 175
- Dynamics | Gate Edit page ..... 62
- Dynamics | Gate Lib page ..... 174
- DYNAMICS button ..... 18
- E**
- EARLY REF. .... 291
- ECHO ..... 294
- EDIT indicator ..... 27
- Edit indicator ..... 20
- Editing events offline ..... 198
- Effect | FX1 Edit page ..... 151
- Effect | FX1 Lib page ..... 170
- Effect | FX2 Edit page ..... 151
- Effect | FX2 Lib page ..... 170
- Effect | FX3 Edit page ..... 151
- Effect | FX3 Lib page ..... 170
- Effect | FX4 Edit page ..... 151
- Effect | FX4 Lib page ..... 170
- Effect | P-IN Edit 2 page ..... 153
- Effect | P-IN Edit 1 page ..... 153
- EFFECT button ..... 18
- Effects  
  Bypass ..... 151  
  EFFECT button ..... 18  
  Internal effects ..... 147  
  Parameter tables ..... 291  
  Plug-ins ..... 153
- Effects library ..... 169  
  Preset ..... 170  
  programs ..... 170
- Effects parameters ..... 291
- Effects processor 1 ..... 147
- EMPHASIS ..... 55
- Encoder | Encoder page ..... 35
- ENCODER MODE section ..... 16
- Encoders ..... 15, 34, 36  
  Assigning parameters ..... 35  
  Encoder mode ..... 34
- ENTER button ..... 21
- Enter titles  
  Title edit window ..... 30
- EQ ..... 65, 82, 86, 92, 94  
  Preset ..... 316
- EQ | ATT 1-16 page ..... 64
- EQ | ATT 17-32 page ..... 64
- EQ | ATT 33-48 page ..... 64
- EQ | EQ Edit page ..... 65, 82, 94
- EQ | EQ Library page ..... 177
- EQ | Out Att page ..... 81, 92
- EQ library ..... 177  
  Preset ..... 177
- EQ link ..... 141
- EQUALIZER DISPLAY button ..... 19
- EQUALIZER FREQUENCY  
  control ..... 19
- EQUALIZER GAIN control ..... 19
- EQUALIZER HIGH button ..... 19
- EQUALIZER HIGH-MID button ..... 19
- EQUALIZER LOW button ..... 19
- EQUALIZER LOW-MID button ..... 19
- EQUALIZER Q control ..... 19
- Event edit page ..... 202
- Event job page ..... 198
- F**
- F & R ..... 127
- F1-F4 buttons ..... 18
- Fader groups ..... 141, 142
- FADER indicator ..... 16, 33
- FADER MODE section ..... 16
- Fader REC Accuracy preference ..... 254
- Fader Touch Sense preference ..... 253
- FADER/AUX button ..... 16
- Fader1 & 2 pages ..... 196
- Fading ..... 160  
  ALL CLEAR ..... 160  
  AUX1-8 ..... 161  
  BUS1-8 ..... 161  
  Global fade time ..... 160  
  INPUT CH1-48 ..... 160  
  STEREO ..... 161

- FAST ..... 126  
Fast Meter Fall Time preference ..... 251  
FB.GAIN ..... 62  
Features ..... 11  
    Automix ..... 12  
    Channel configuration ..... 12  
    Effects ..... 12  
    Hardware ..... 11  
    Inputs and Outputs ..... 11  
    MIDI ..... 12  
    Remote control ..... 12  
    Scene memory ..... 12  
    Sonic specifications ..... 11  
    Surround sound ..... 12  
Fixed mode ..... 98, 101  
FLANGE ..... 295  
FLANGE 5.1 ..... 312  
Follow pan function ..... 68  
FOLLOW SURROUND ..... 148  
Frame Jump Error preference ..... 254  
FRAMES ..... 182  
FREEZE ..... 309  
FS ..... 55
- G**
- GAIN controls ..... 14, 51  
Gain of the AD card ..... 41  
GANG ..... 67  
Gate library ..... 174  
GATE REVERB ..... 292  
Gates ..... 62  
    DYNAMICS button ..... 18  
    KEYIN SOURCE ..... 62  
    Parameter table ..... 328  
    Preset parameters ..... 320  
GPI ..... 259  
    Parameters ..... 261  
    Sources ..... 262  
    Trigger source list ..... 286  
GRAB button ..... 19  
Grounding screw ..... 25  
Group ..... 141  
    Fader groups ..... 142  
    Mute groups ..... 142
- H**
- Hard disk  
    Recording system ..... 42  
Headphones & talkback section ..... 21  
Higher sampling rates ..... 57  
HORIZONTAL ..... 75  
HQ. PITCH ..... 297
- I**
- I/O card ..... 53  
    Installing ..... 26  
    SLOT 1–2 ..... 52  
IEEE1394 ..... 53  
In Patch | Cascade In page ..... 267  
In Patch | CH Name page ..... 76  
In Patch | Effect page ..... 148  
In Patch | In Patch page ..... 47, 106  
In Patch | Insert In page ..... 114  
In Patch | Library page ..... 168  
INDIVIDUAL ..... 67  
INIT ..... 125  
Initial Data Nominal preference ..... 252  
Initializing the DM1000 ..... 273  
Input channels ..... 59  
    Attenuating ..... 64  
    Compressing ..... 63  
    Delaying ..... 61  
    EQ ..... 72  
    EQ'ing ..... 65  
    Gating ..... 62  
    Levels ..... 71  
    Naming ..... 76  
    Pairing ..... 73  
    Panning ..... 67, 71  
    Routing ..... 68, 72  
    Setting from the control surface ..... 71  
    Setting from the display ..... 60  
    Switching the signal phase ..... 60  
    Viewing the settings ..... 69  
INPUT connectors ..... 23, 51  
Input patch ..... 105  
    Initial settings ..... 280  
    Parameters ..... 278  
INPUT PATCH button ..... 17, 106  
Input patch library ..... 168  
Input sensitivity  
    GAIN controls ..... 14  
INS button ..... 30  
Insert in ..... 114  
Insert patching ..... 112  
Installing a card ..... 26  
INT 44.1k, INT 48k, INT 88.2,  
    INT 96k ..... 46  
INT START TIME ..... 191  
Internal effects  
    Aux sends ..... 148  
    Editing ..... 151  
    Effects processors 2 through 4 ..... 147  
    FOLLOW SURROUND ..... 148  
    Inserting into channels ..... 150  
    Meters ..... 152  
    MIDI CLK ..... 152  
    MIX BALANCE ..... 151  
    TAP TEMPO ..... 152  
    TEMPO ..... 151, 152  
INV GANG ..... 67
- J**
- Joystick ..... 19  
    Reverb 5.1 effect ..... 310  
Joystick Auto Grab preference ..... 252
- K**
- KEYIN SOURCE ..... 62
- L**
- L/R Nominal Pan preference ..... 251  
LAST SOLO ..... 116  
LATCH ..... 230  
LAYER section ..... 20  
Layers ..... 31  
    Initial bank settings ..... 287  
LEARN button ..... 228  
Levels ..... 86, 92  
LFE ..... 127  
Libraries ..... 165  
    Bus to stereo library ..... 173  
    Channel library ..... 167  
    Compressor library ..... 175  
    Effects library ..... 169  
    EQ library ..... 177  
    Gate library ..... 174  
    General operation ..... 165  
    Input patch library ..... 168  
    Output patch library ..... 169  
    specifications ..... 330  
    Surround monitor library ..... 179  
Link ..... 141  
    Compressors ..... 144  
    EQ ..... 144  
Link Capture & Locate Memory  
    preference ..... 254  
Lock Time preference ..... 254
- M**
- M.BAND DYNA. .... 313  
Machine control ..... 231  
MASTER button ..... 20  
MASTER MODE ..... 38  
MB1000 peak meter bridge ..... 368  
Meter | CH1-32 page ..... 37  
Meter | CH1-48 page ..... 37  
Meter | CH33-48 page ..... 37  
Meter | Effect page ..... 37  
Meter | Master page ..... 37  
Meter | Position page ..... 37  
Meter | Stereo page ..... 38  
Meter bridge ..... 368  
METER button ..... 17, 37  
METER connector ..... 24  
Meter Follow Layer preference ..... 252  
Metering ..... 37  
Meters  
    Stereo meters ..... 18  
MIDI ..... 207, 235  
    Bulk dump ..... 246  
    Bulk dump messages ..... 235  
    Control changes ..... 240  
    Data format ..... 353  
    FADER H/L ..... 244  
    Initial parameter to control  
        change table ..... 337  
    MIDI clock ..... 235  
    MIDI IN & OUT ports ..... 24, 235  
    MIDI indicator ..... 27  
    MIDI note on/off ..... 235  
    Parameter changes ..... 246  
    Parameters ..... 241  
    Program changes ..... 239  
    REMOTE connector ..... 236  
    Scene memory to program  
        change table ..... 336  
    Setup ..... 236

- SLOT 1 ..... 236  
 System exclusive messages ..... 235  
 Transmission and Reception ..... 238  
 USB port ..... 236
- MIDI | Bulk page ..... 247  
 MIDI | Ctl Asgn page ..... 240  
 MIDI | Pgm Asgn page ..... 239  
 MIDI | Setup page ..... 238  
 MIDI button ..... 17  
 MIDI interface ..... 207  
 MIDI machine control ..... 235  
 MIDI remote ..... 225  
   Banks ..... 225  
   LATCH ..... 230  
   LEARN button ..... 228  
   MIDI messages ..... 228  
   TARGET parameter ..... 226  
   UNLATCH ..... 230  
 MIDI timecode ..... 235  
 MIDI Warning preference ..... 251  
 mini-YGDAI I/O cards ..... 53  
 Mix minus ..... 103  
 MIX SOLO ..... 116  
 Mix Update Confirmation  
   preference ..... 253  
 MIXDOWN ..... 116  
 mLAN I/O card ..... 53  
 MMC ..... 205, 231, 235  
 MOD. DELAY ..... 293  
 MOD. FILTER ..... 299  
 Monitor | Solo/C-R page ..... 116  
 Monitor | Surr Lib page ..... 179  
 Monitor | Surr Patch page ..... 139  
 Monitor | Surr Setup page ..... 133, 138  
 Monitor | Surround page ..... 137  
 Monitor | Talkback page ..... 119  
 Monitor alignment ..... 136  
 MONITOR LEVEL control ..... 22  
 Monitor matrix ..... 133  
 MONITOR section ..... 22  
 Monitoring ..... 115  
   CONTROL ROOM DIMMER  
     LEVEL ..... 117  
   Digital input channel status ..... 55  
   DIMM (Dimmer) ..... 115  
   LAST SOLO ..... 116  
   MIX SOLO ..... 116  
   MIXDOWN ..... 116  
   MONO ..... 117  
   MUTE/SOLO section ..... 137  
   RECORDING ..... 116  
   SETTING section ..... 137  
   Solo function ..... 118  
   SOLO SAFE ..... 117  
   Solo safe function ..... 117  
   Solo setup ..... 116  
   SPEAKER SETUP ..... 138  
   STATUS section ..... 137  
   Talkback function ..... 119  
 MONO ..... 117  
 MONO DELAY ..... 292  
 MS buttons ..... 74  
 MS microphone ..... 74, 77
- MTC ..... 235  
 MULTI FILTER ..... 308  
 Mute groups ..... 141, 142  
 MUTE/SOLO section ..... 137  
 Muting ..... 217
- N**  
 Naming ..... 76, 89  
 Nuendo ..... 205, 224
- O**  
 OCTA REVERB ..... 310  
 OFFSET ..... 191  
 OMNI IN connectors ..... 23, 51  
 OMNI OUT connectors ..... 23, 48, 52  
 Omni outs ..... 52  
 OMS ..... 207  
 ON buttons ..... 15  
 Operating basics ..... 27  
   About the display ..... 27  
   AUX indicator ..... 33  
   Buttons ..... 29  
   Channel name ..... 28  
   Confirmation messages ..... 30  
   FADER indicator ..... 33  
   Metering ..... 37  
   Page area ..... 28  
   Page tabs ..... 28  
   Page title ..... 28  
   Parameter boxes ..... 29  
   Rotary controls & faders ..... 29  
   Sampling rate indicator ..... 28  
   Selecting channels ..... 32  
   Selecting display pages ..... 28  
   Selecting encoder modes ..... 34  
   Selecting fader modes ..... 33  
   Selecting layers ..... 31  
   Tab scroll arrows ..... 28  
   Timecode counter ..... 28  
   Title edit window ..... 30  
 OPERATION LOCK ..... 263  
 Operation lock ..... 263  
 Optional card ..... 26  
   Installing ..... 26  
 Options ..... 6, 368  
   I/O card ..... 53  
   MB1000 ..... 368  
   RK1 ..... 371  
   SP1000 ..... 371  
 Oscillator ..... 256  
 Other functions ..... 249  
   Preferences ..... 250  
 Out Patch | 2TR Out page ..... 110  
 Out Patch | CH Name page ..... 89  
 Out Patch | Direct Out page ..... 111  
 Out Patch | Library page ..... 169  
 Out Patch | Omni Out page ..... 48, 109  
 Out Patch | Slot Out page ..... 110, 125, 266  
 Output patch ..... 108  
   Initial settings ..... 284  
   Parameters ..... 282  
 OUTPUT PATCH button ..... 17  
 Output patch library ..... 169
- P**  
 P2 ..... 205, 231  
   Straight cable ..... 24  
 Package contents ..... 6  
 PAD switches ..... 14, 51  
 Pair Confirmation preference ..... 251  
 PAIR/GROUP button ..... 17  
 Pair/Grup | Fader1–32 page ..... 142  
 Pair/Grup | Fader33–48 page ..... 142  
 Pair/Grup | In Comp page ..... 145  
 Pair/Grup | In EQ page ..... 144  
 Pair/Grup | Input page ..... 74  
 Pair/Grup | Mute1–32 page ..... 142  
 Pair/Grup | Mute33–48 page ..... 142  
 Pair/Grup | Out Comp page ..... 145  
 Pair/Grup | Out EQ page ..... 144  
 Pair/Grup | Out Fader page ..... 142  
 Pair/Grup | Out Mute page ..... 142  
 Pair/Grup | Output page ..... 87  
 Pairing ..... 73, 87  
   HORIZONTAL ..... 75  
   Using the display ..... 74  
   Using the SEL buttons ..... 73  
   VERTICAL ..... 75  
 PAN button ..... 16  
 Pan/Surr | Ch Edit page ..... 126  
 Pan/Surr | Pan1–32 page ..... 67  
 Pan/Surr | Pan33–48 page ..... 67  
 Pan/Surr | Surr Mode page ..... 123  
 Pan/Surr | Surr1–16 page ..... 130  
 Pan/Surr | Surr17–32 page ..... 130  
 Pan/Surr | Surr33–48 page ..... 130  
 PAN/SURR LINK ..... 123  
 PAN/SURROUND button ..... 17  
 Panning ..... 67, 102  
   F.S button ..... 87  
   FOLLOW PAN ..... 71  
   Follow pan function ..... 68  
   GANG ..... 67  
   INDIVIDUAL ..... 67  
   INV GANG ..... 67  
   PAN buttons ..... 68  
 Parameter boxes ..... 29  
 Parameter changes ..... 246  
 Parameter lists ..... 275  
 Parameter wheel ..... 21  
 Patch Confirmation preference ..... 251  
 Patching ..... 105  
   2TR digital outputs ..... 110  
   Direct outs ..... 111  
   Input and Output ..... 47  
   Input channels ..... 47  
   INPUT PATCH button ..... 17, 47  
   Input patching ..... 105  
   Input patching from the display ..... 106  
   Insert in ..... 114  
   Insert patching ..... 112  
   Omni outs ..... 48, 109  
   OUTPUT PATCH button ..... 17  
   Output patching ..... 108  
   PAN/SURROUND button ..... 17  
   Slot outputs ..... 110  
   Using the encoders ..... 107

- PEAK indicators ..... 14, 51  
Peak level ..... 39  
Phantom power ..... 51  
  +48V ON/OFF switches ..... 14  
Phase ..... 60  
PHASER ..... 296  
PHONES jack ..... 21, 115  
PHONES LEVEL control ..... 21  
PLAY ..... 194  
PLUG-IN ..... 248  
Plug-ins ..... 219  
  Y56K ..... 153  
Port ID/PORT preference ..... 252  
POWER ON/OFF switch ..... 25  
Power section ..... 25  
Prefer1 page ..... 250  
Prefer2 page ..... 252  
Prefer3 page ..... 253  
Preferences ..... 250  
Preset compressor parameters ..... 320  
Preset EQ parameters ..... 316  
Preset gate parameters ..... 320  
Pro tools ..... 205, 206, 217  
  Automation ..... 223  
  Channel display mode ..... 211  
  Channel levels ..... 216  
  Control surface operation ..... 212  
  Display ..... 210  
  Explicit mute ..... 217  
  Flip mode ..... 218  
  Implicit mute ..... 217  
  Insert display mode ..... 210  
  Meter display mode ..... 212  
  MIDI ..... 207  
  Muting ..... 218  
  OMS ..... 207  
  Panning ..... 217, 218  
  Plug-ins ..... 219  
  Pre or Post ..... 217  
  Scrub & Shuttle ..... 222  
  Selecting ..... 216  
  Send levels ..... 218  
  Soloing ..... 217  
Program changes ..... 235, 239  
PROTECT button ..... 158  
Punching in & out ..... 188
- R**
- Rear panel ..... 23  
  AD input and output section ..... 23  
  Digital I/O & control section ..... 24  
  Power section ..... 25  
  SLOT section ..... 24  
REC ..... 194  
RECALL button ..... 20  
Recall Confirmation preference ..... 251  
Recall safe function ..... 162  
Receive Full Frame Message  
  preference ..... 254  
RECORDING ..... 116  
Remote ..... 205  
  AD824 ..... 270  
  Display ..... 210  
  FRAMES ..... 233  
  Insert display mode ..... 210  
  LOCATE/TIME section ..... 233  
  Machine control ..... 205, 231  
  MACHINE CONTROL section ..... 232  
  MIDI messages ..... 228  
  MIDI remote ..... 225  
  MMC ..... 205  
  Nuendo ..... 205  
  P2 ..... 205  
  ProTools ..... 205  
  REMOTE 1/2 ..... 205  
  Target parameter ..... 209  
  TRACK ARMING section ..... 233  
  TRANSPORT section ..... 233  
  Remote | Channel page ..... 223  
  Remote | Insert page ..... 209  
  Remote | Machine page ..... 233  
  Remote | Meter page ..... 212  
  Remote | Remote 1 page ..... 208  
  Remote | Remote 2 page ..... 226  
  REMOTE 1/REMOTE 2 buttons ..... 20  
  REMOTE button ..... 17, 205  
  REMOTE connector ..... 24, 236  
  Remote layer  
    Nuendo ..... 224  
    Pro tools ..... 206  
  RESET BOTH ..... 74  
  REV+CHORUS ..... 302  
  REV+FLANGE ..... 303  
  REV+SYMPHO. .... 304  
  REV->CHORUS ..... 302  
  REV->FLANGE ..... 303  
  REV->PAN ..... 305  
  REV->SYMPHO. .... 304  
  REVERB 5.1 ..... 310  
  REVERB HALL ..... 291  
  REVERB PLATE ..... 291  
  REVERB ROOM ..... 291  
  REVERB STAGE ..... 291  
  Reverse cable ..... 266, 270  
  REVERSE GATE ..... 292  
  RING MOD. .... 299  
  RK1 rack mount kit ..... 371  
  ROTARY ..... 298  
  Rotary controls & faders ..... 29  
  Routing ..... 68  
  Routing | Bus To St page ..... 83  
  Routing | CH1-16 page ..... 68  
  Routing | CH17-32 page ..... 68  
  Routing | CH33-48 page ..... 68  
  Routing | Library page ..... 173  
  ROUTING 1-8 buttons ..... 19  
  ROUTING DIRECT button ..... 19  
  ROUTING DISPLAY button ..... 19  
  ROUTING STEREO button ..... 19
- S**
- Sampling rates ..... 53, 55  
  DOUBLE CHANNEL ..... 57  
  DOUBLE SPEED ..... 57  
  Sampling rate indicator ..... 28  
  Setting the higher sampling rates ..... 57  
  SINGLE ..... 58  
  SRC sections ..... 54  
  Scene | In Fade page ..... 160  
  Scene | Out Fade page ..... 161  
  Scene | Rcl Safe page ..... 162  
  Scene | Scene page ..... 158  
  Scene | Sort page ..... 163  
  SCENE button ..... 18  
  Scene MEM Auto Update  
    preference ..... 252  
  Scene memories ..... 155  
    Auto update function ..... 159  
    Edit indicators ..... 156  
    Fading ..... 160  
    PROTECT button ..... 158  
    Recall safe function ..... 162  
    Scene numbers ..... 156  
    Shadow memory ..... 159  
    Sorting ..... 163  
    Storing and Recalling ..... 157  
    Using the Scene Memory Page ..... 158  
    What is stored ..... 155  
  Scene memory #0 ..... 156  
  Scene memory #U ..... 156  
  Scene memory display ..... 20  
  SCENE MEMORY section ..... 20  
  Scene numbers ..... 156  
  Scene up/down buttons ..... 20  
  SEL buttons ..... 15  
  SELECTED CHANNEL section ..... 19  
  Selecting channels ..... 32  
  Selecting display pages ..... 28  
  Selecting fader modes ..... 33  
  SET SPL85 ..... 137  
  Setting levels ..... 96  
  SETTING section ..... 137  
  Setup ..... 41  
  Setup | GPI page ..... 259  
  Setup | In Port page ..... 249  
  Setup | MIDI/Host page  
    ..... 208, 232, 236, 268  
  Setup | Out Port page ..... 250  
  Setup | Output Att page ..... 88  
  Setup | Prefer1 page ..... 250  
  Setup | Prefer2 page ..... 250  
  Setup | Prefer3 page ..... 250  
  Setup | Remote page ..... 268, 271  
  Setup | Surr Bus page ..... 125  
  Setup | Time Ref page ..... 182  
  Setup | Time Sig page ..... 183  
  SETUP button ..... 17  
  Shadow memory ..... 159  
  SHIFT LOCK button ..... 30  
  Show Compact Size preference ..... 254  
  SIGNAL indicators ..... 14, 51  
  SINGLE ..... 236  
  SLOT 1 ..... 24, 46, 52  
  SLOT 1/2 ..... 22, 132  
  SLOT button ..... 24  
  SLOT section ..... 24  
  SMPTE TIME CODE INPUT  
    connector ..... 24  
  SNAP TO SPL85 ..... 138



- Solo ..... 116  
 2TR DIN FLIP ..... 117  
 LAST SOLO ..... 116  
 LISTEN ..... 116  
 MIX SOLO ..... 116  
 MIXDOWN ..... 116  
 RECORDING ..... 116  
 SOLO ..... 116  
 Solo function ..... 118  
 SOLO INTERRUPTION ..... 117  
 SOLO SAFE CHANNEL ..... 117  
 Solo safe function ..... 117  
 SOLO TRIM ..... 117  
 SOLO buttons ..... 15  
 SOLO indicator ..... 22  
 SOLO SAFE ..... 117  
 SP1000 side panels ..... 371  
 SPEAKER SETUP ..... 138  
 Specifications ..... 325  
 SRC sections ..... 54  
 Star distribution ..... 44  
 STATUS section ..... 137  
 STEREO button ..... 22  
 STEREO DELAY ..... 292  
 STEREO fader ..... 15  
 Stereo meters ..... 18  
 Stereo out ..... 79  
   Attenuating ..... 81  
   Compressing ..... 82  
   Delaying ..... 81  
   EQ'ing ..... 82, 86  
   Naming ..... 89  
   Pairing ..... 87  
   Setting from the control surface .. 86  
   Setting from the display ..... 81  
   Setting the levels ..... 86  
   Viewing the settings ..... 84  
 STEREO section ..... 15  
 STOP ..... 194  
 STORE button ..... 20  
 Store Confirmation preference ..... 251  
 Storing and Recalling ..... 157  
 SURR. MODE ..... 133  
 Surround ..... 121  
   BASS MANAGEMENT ..... 134  
   BUS1–BUS8 ..... 125  
   DIV ..... 127  
   F & R ..... 127  
   F.S button ..... 87  
   FAST ..... 126  
   GRAB button ..... 19  
   INIT ..... 125  
   Joystick ..... 19  
   LFE ..... 127  
   LINK ..... 127  
   MONITOR ALIGNMENT ..... 136  
   Monitoring ..... 131  
   Monitoring matrix ..... 131  
   Oscillator ..... 138  
   Pan graph ..... 126  
   PAN/SURR LINK ..... 123  
   PAN/SURROUND button ..... 17  
   Panning from the display ..... 126  
   PATTERN ..... 127  
   Setting up and Selecting ..... 123  
   Slot ..... 139  
   SPEAKER SETUP ..... 138  
   ST LINK ..... 127  
   Surround effects ..... 153  
   SURROUND MODE ..... 69, 123  
   Surround mode indicator ..... 28  
   Surround pan ..... 121  
   Trajectory patterns ..... 126  
 SURROUND MODE ..... 123  
 Surround mode indicator ..... 28  
 Surround modes ..... 121, 123, 133  
   Factory-default ..... 122  
 Surround monitor ..... 131  
   Bass management ..... 133  
   Configuring basic ..... 133  
   Monitor alignment ..... 133  
   Monitor matrix ..... 133  
   Monitoring level ..... 137  
 Surround monitor library ..... 179  
 Surround pan ..... 121  
 SYMPHO. 5.1 ..... 312  
 SYMPHONIC ..... 295  
 SYNC parameter ..... 269  
 System exclusive messages ..... 235  
 System version ..... 272
- T**  
 Tab scroll arrows ..... 28  
 Tab scroll buttons ..... 18  
 TALKBACK button ..... 22, 119  
 Talkback function ..... 119  
 TALKBACK LEVEL control ..... 21  
 Talkback mic ..... 21  
 Target parameter ..... 209  
 Tascam I/O card ..... 53  
 TC Drop Warning preference ..... 251  
 TIME REFERENCE ..... 191  
 TIME REFERENCE section ..... 182  
 Time signature map ..... 183  
 Timecode counter ..... 28  
 Timecode Display Relative  
   preference ..... 254  
 Timecode source ..... 182  
 Title edit window ..... 30  
 TO END button ..... 191  
 TO HOST USB port ..... 24  
 Trajectory patterns ..... 127  
 TREMOLO ..... 297  
 Trigger signals ..... 259
- U**  
 UNLATCH ..... 230  
 UPDATE ..... 191  
 USB ..... 24  
   OMS ..... 207  
   USB port ..... 236  
 User assignable layer ..... 255  
 User Def | User Def page ..... 257  
 USER DEFINED KEYS ..... 21  
   Initial assignments ..... 277  
 User defined keys ..... 257
- Utility | Battery page ..... 272  
 Utility | CH Status page ..... 55  
 Utility | Lock page ..... 263  
 Utility | Oscillator page ..... 256  
 UTILITY button ..... 17
- V**  
 Variable mode ..... 98, 101  
 VERTICAL ..... 75  
 View | Fader page ..... 70, 84, 95  
 View | Library page ..... 167  
 View | Parameter page ..... 69, 84, 94  
 VIEW button ..... 17
- W**  
 WC IN ..... 46  
 Web site ..... 6, 53  
 Welcome ..... 11  
 Window  
   Changing the surround mode ... 124  
   Channel Pairing ..... 73  
   Copy operation ..... 104  
   Password ..... 263  
   Set Password ..... 264  
   User Define Select ..... 258  
 Wordclock ..... 44  
   About wordclock ..... 44  
   Connections ..... 44  
   Daisy chain distribution ..... 44  
   Source ..... 46  
   Specifying source ..... 45  
   Star distribution ..... 44  
   WC IN ..... 46  
   WORD CLOCK IN connector .... 25  
   WORD CLOCK OUT connector 24
- Y**  
 Y56K ..... 153  
 Yamaha web site ..... 6, 53

MIDI Implementation Chart

Function...		Transmitted	Recognized	Remarks
Basic Channel	Default Changed	1-16 1-16	1-16 1-16	Memorized
Mode	Default Messages Altered	X X *****	OMNI off/OMNI on X X	Memorized
Note Number	True Voice	X *****	0-127 X	
Velocity	Note On Note Off	X X	0 0	Effect Control
After	Key's Ch's	X X	X X	
Pitch Bend		X	X	
Control Change	0-95,102-119	0	0	Assignable
Prog Change	:True#	0-127 *****	0-127 0-99	Assignable
System Exclusive		0	0	*1
System Common	:Song Pos :Song Sel :Tune	X X X	0 X X	Automix
System Real Time	:Clock :Commands	X X	0 0	Automix, Effect Control
Aux Messages	:Local ON/OFF :All Notes OFF :Active Sense :Reset	X X X X	X X 0 0	
Notes	MTC quarter frame message is recognized. *1: Bulk Dump/Request, Parameter Change/Request, and MMC. For MIDI Remote, ALL messages can be transmitted.			

Mode 1: OMNI ON, POLY  
Mode 3: OMNI OFF, POLY

Mode 2: OMNI ON, MONO  
Mode 4: OMNI OFF, MONO

0: Yes  
X: No

# DM1000 Block Diagram

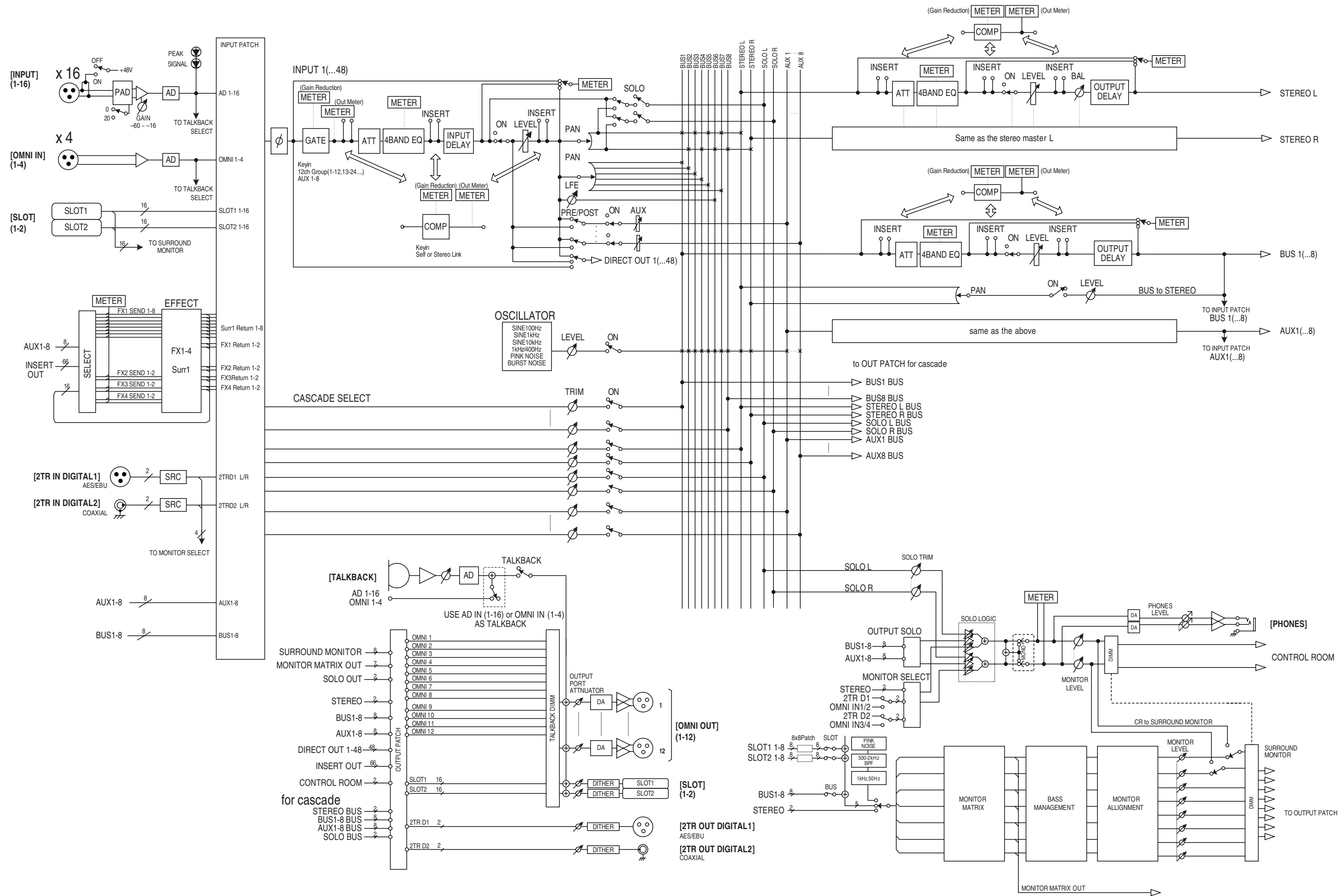

# DM1000 Level Diagram

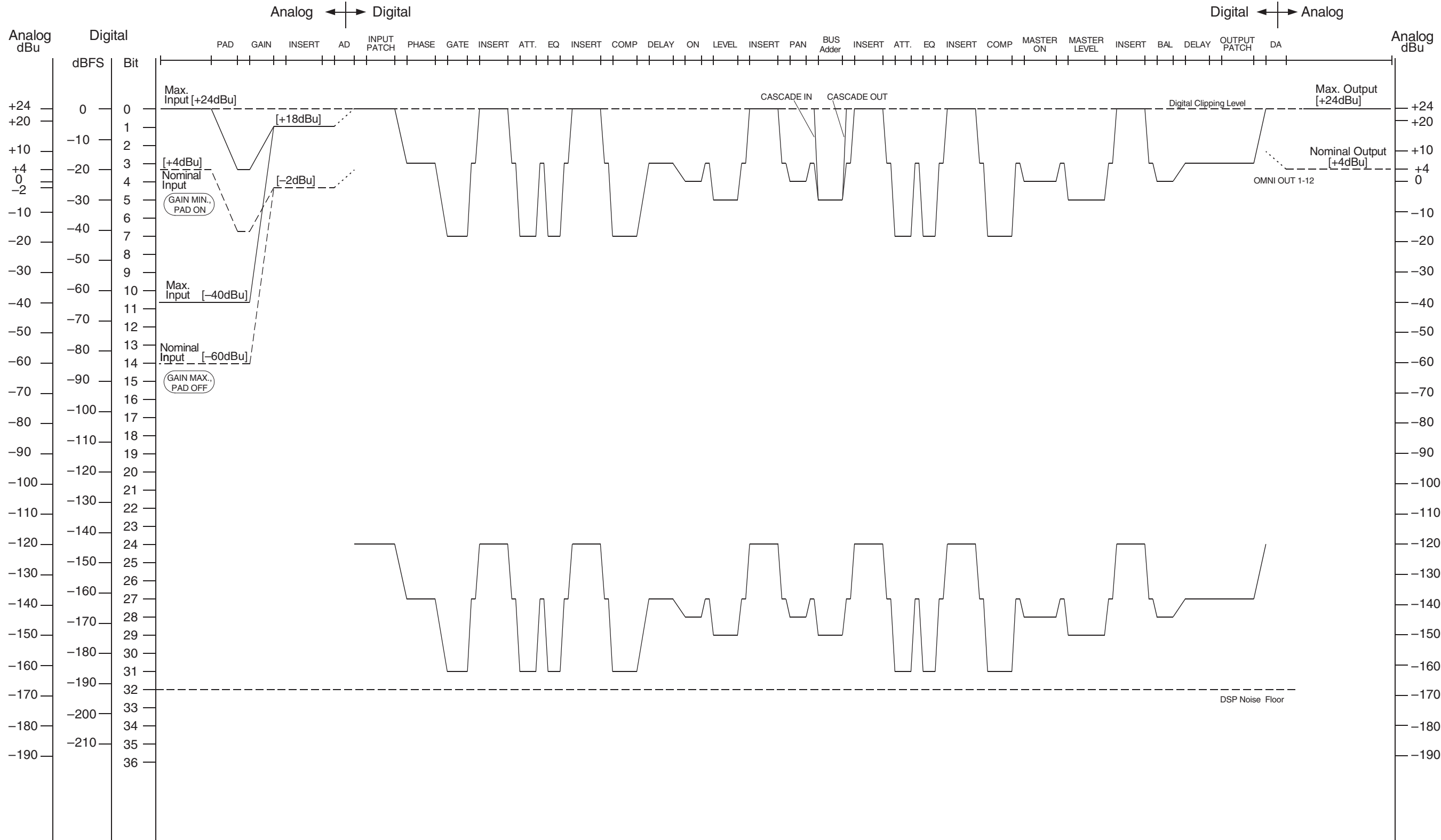

[0dBu = 0.775Vrms]  
 [0dBFS = Full Scale]

For details of products, please contact your nearest Yamaha representative or the authorized distributor listed below.

Pour plus de détails sur les produits, veuillez-vous adresser à Yamaha ou au distributeur le plus proche de vous figurant dans la liste suivante.

Die Einzelheiten zu Produkten sind bei Ihrer unten aufgeführten Niederlassung und bei Yamaha Vertragshändlern in den jeweiligen Bestimmungsländern erhältlich.

Para detalles sobre productos, contacte su tienda Yamaha más cercana o el distribuidor autorizado que se lista debajo.

## NORTH AMERICA

### CANADA

**Yamaha Canada Music Ltd.**  
135 Milner Avenue, Scarborough, Ontario,  
M1S 3R1, Canada  
Tel: 416-298-1311

### U.S.A.

**Yamaha Corporation of America**  
6600 Orangethorpe Ave., Buena Park, Calif. 90620,  
U.S.A.  
Tel: 714-522-9011

## CENTRAL & SOUTH AMERICA

### MEXICO

**Yamaha de Mexico S.A. De C.V.,  
Departamento de ventas**  
Javier Rojo Gomez No.1149, Col. Gpe Del  
Moral, Deleg. Iztapalapa, 09300 Mexico, D.F.  
Tel: 686-00-33

### BRAZIL

**Yamaha Musical do Brasil LTDA.**  
Av. Rebouças 2636, São Paulo, Brasil  
Tel: 011-853-1377

### ARGENTINA

**Yamaha Music Latin America, S.A.  
Sucursal de Argentina**  
Viamonte 1145 Piso2-B 1053,  
Buenos Aires, Argentina  
Tel: 1-4371-7021

### PANAMA AND OTHER LATIN AMERICAN COUNTRIES/ CARIBBEAN COUNTRIES

**Yamaha Music Latin America, S.A.**  
Torre Banco General, Piso 7, Urbanización Marbella,  
Calle 47 y Aquilino de la Guardia,  
Ciudad de Panamá, Panamá  
Tel: +507-269-5311

## EUROPE

### THE UNITED KINGDOM

**Yamaha-Kemble Music (U.K.) Ltd.**  
Sherbourne Drive, Tilbrook, Milton Keynes,  
MK7 8BL, England  
Tel: 01908-366700

### GERMANY

**Yamaha Music Central Europe GmbH**  
Siemensstraße 22-34, 25462 Rellingen, Germany  
Tel: 04101-3030

### SWITZERLAND/LIECHTENSTEIN

**Yamaha Music Central Europe GmbH,  
Branch Switzerland**  
Seefeldstrasse 94, 8008 Zürich, Switzerland  
Tel: 01-383 3990

### AUSTRIA

**Yamaha Music Central Europe GmbH,  
Branch Austria**  
Schleiergasse 20, A-1100 Wien, Austria  
Tel: 01-60203900

### THE NETHERLANDS

**Yamaha Music Central Europe,  
Branch Nederland**  
Clarissenhof 5-b, 4133 AB Vianen, The Netherlands  
Tel: 0347-358 040

## BELGIUM/LUXEMBOURG

**Yamaha Music Central Europe GmbH,  
Branch Belgium**  
Rue de Geneve (Genevastraat) 10, 1140 - Brussels,  
Belgium  
Tel: 02-726 6032

## FRANCE

**Yamaha Musique France, S.A.  
Division Professionnelle**  
BP 70-77312 Marne-la-Vallée Cedex 2, France  
Tel: 01-64-61-4000

## ITALY

**Yamaha Musica Italia S.P.A.  
Combo Division**  
Viale Italia 88, 20020 Lainate (Milano), Italy  
Tel: 02-935-771

## SPAIN/PORTUGAL

**Yamaha-Hazen Música, S.A.**  
Ctra. de la Coruna km. 17, 200, 28230  
Las Rozas (Madrid), Spain  
Tel: 91-639-8888

## SWEDEN

**Yamaha Scandinavia AB**  
J. A. Wettergrens Gata 1  
Box 30053  
S-400 43 Göteborg, Sweden  
Tel: 031 89 34 00

## DENMARK

**YS Copenhagen Liaison Office**  
Generatorvej 8B  
DK-2730 Herlev, Denmark  
Tel: 44 92 49 00

## NORWAY

**Norsk filial av Yamaha Scandinavia AB**  
Grini Næringspark 1  
N-1345 Østerås, Norway  
Tel: 67 16 77 70

## OTHER EUROPEAN COUNTRIES

**Yamaha Music Central Europe GmbH**  
Siemensstraße 22-34, 25462 Rellingen, Germany  
Tel: +49-4101-3030

## AFRICA

**Yamaha Corporation,  
Asia-Pacific Music Marketing Group**  
Nakazawa-cho 10-1, Hamamatsu, Japan 430-8650  
Tel: +81-53-460-2313

## MIDDLE EAST

### TURKEY/CYPRUS

**Yamaha Music Central Europe GmbH**  
Siemensstraße 22-34, 25462 Rellingen, Germany  
Tel: 04101-3030

### OTHER COUNTRIES

**Yamaha Music Gulf FZE**  
LB21-128 Jebel Ali Freezone  
P.O.Box 17328, Dubai, U.A.E.  
Tel: +971-4-881-5868

## ASIA

### INDONESIA

**PT. Yamaha Music Indonesia (Distributor)  
PT. Nusantik**  
Gedung Yamaha Music Center, Jalan Jend. Gatot  
Subroto Kav. 4, Jakarta 12930, Indonesia  
Tel: 21-520-2577

### KOREA

**Yamaha Music Korea Ltd.**  
Tong-Yang Securities Bldg. 16F 23-8 Yoido-dong,  
Youngdungpo-ku, Seoul, Korea  
Tel: 02-3770-0661

### MALAYSIA

**Yamaha Music Malaysia, Sdn., Bhd.**  
Lot 8, Jalan Perbandaran, 47301 Kelana Jaya,  
Petaling Jaya, Selangor, Malaysia  
Tel: 3-703-0900

### SINGAPORE

**Yamaha Music Asia Pte., Ltd.**  
11 Ubi Road #06-00, Meiban Industrial Building,  
Singapore  
Tel: 65-747-4374

### TAIWAN

**Yamaha KHS Music Co., Ltd.**  
3F, #6, Sec.2, Nan Jing E. Rd. Taipei.  
Taiwan 104, R.O.C.  
Tel: 02-2511-8688

### THAILAND

**Siam Music Yamaha Co., Ltd.**  
121/60-61 RS Tower 17th Floor,  
Ratchadaphisek RD., Dindaeng,  
Bangkok 10320, Thailand  
Tel: 02-641-2951

### THE PEOPLE'S REPUBLIC OF CHINA

**Yamaha Music & Electronics (China) Co., Ltd.  
Shanghai Branch**  
United Plaza 25F 1468 Nan Jing Road West  
Jingan Shanghai 200040, China  
Tel: 21-6247-2211

### OTHER ASIAN COUNTRIES

**Yamaha Corporation,  
Asia-Pacific Music Marketing Group**  
Nakazawa-cho 10-1, Hamamatsu, Japan 430-8650  
Tel: +81-53-460-2313

## OCEANIA

### AUSTRALIA

**Yamaha Music Australia Pty. Ltd.**  
Level 1, 99 Queensbridge Street, Southbank,  
Victoria 3006, Australia  
Tel: 3-9693-5111

### COUNTRIES AND TRUST TERRITORIES IN PACIFIC OCEAN

**Yamaha Corporation,  
Asia-Pacific Music Marketing Group**  
Nakazawa-cho 10-1, Hamamatsu, Japan 430-8650  
Tel: +81-53-460-2313

**HEAD OFFICE** Yamaha Corporation, Pro Audio & Digital Musical Instrument Division  
Nakazawa-cho 10-1, Hamamatsu, Japan 430-8650  
Tel: +81-53-460-2441

